

Passive DAS

LOW-PIM | FUTURE-PROOF 5G

# PASSIVE LOW-PIM COMPONENTS FOR DISTRIBUTED ANTENNA SYSTEMS

In-Building Coverage Solutions  
by Telegärtner

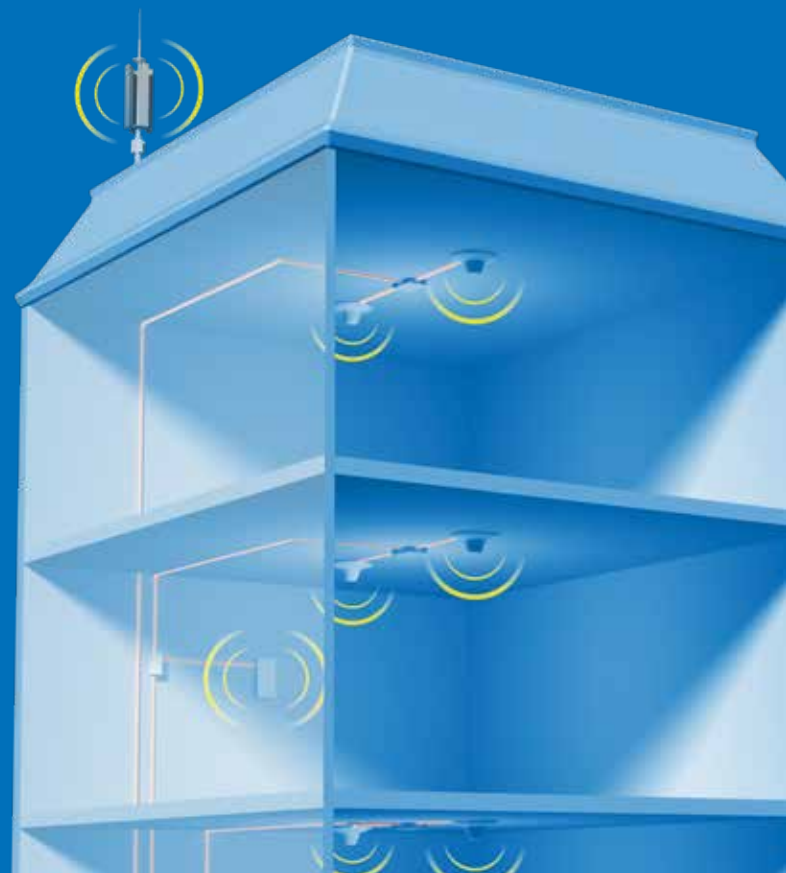

# DISTRIBUTED ANTENNA SYSTEMS

## For reliable coverage.

Today we want to be connected everywhere. Therefore, mobile radio connections must not end at the entrance to larger buildings. Especially in large premises, there is a need for comprehensive network coverage for good signals – always and everywhere.

Coverage is one critical requirement for deploying mobile communication networks. This is true for all cell architectures such as macro, micro, small and pico cells. For reaching all users in a cellular network, in-building coverage also needs to be ensured. Especially on the lower floors in large buildings, network availability is limited,

if the building is not equipped with a Distributed Antenna System. This solution is implemented to achieve optimal coverage and provide maximum capacity in larger premises such as shopping malls, stadiums, concert halls, airports, hotels, (underground) train stations or large office buildings.

# DAS 5G

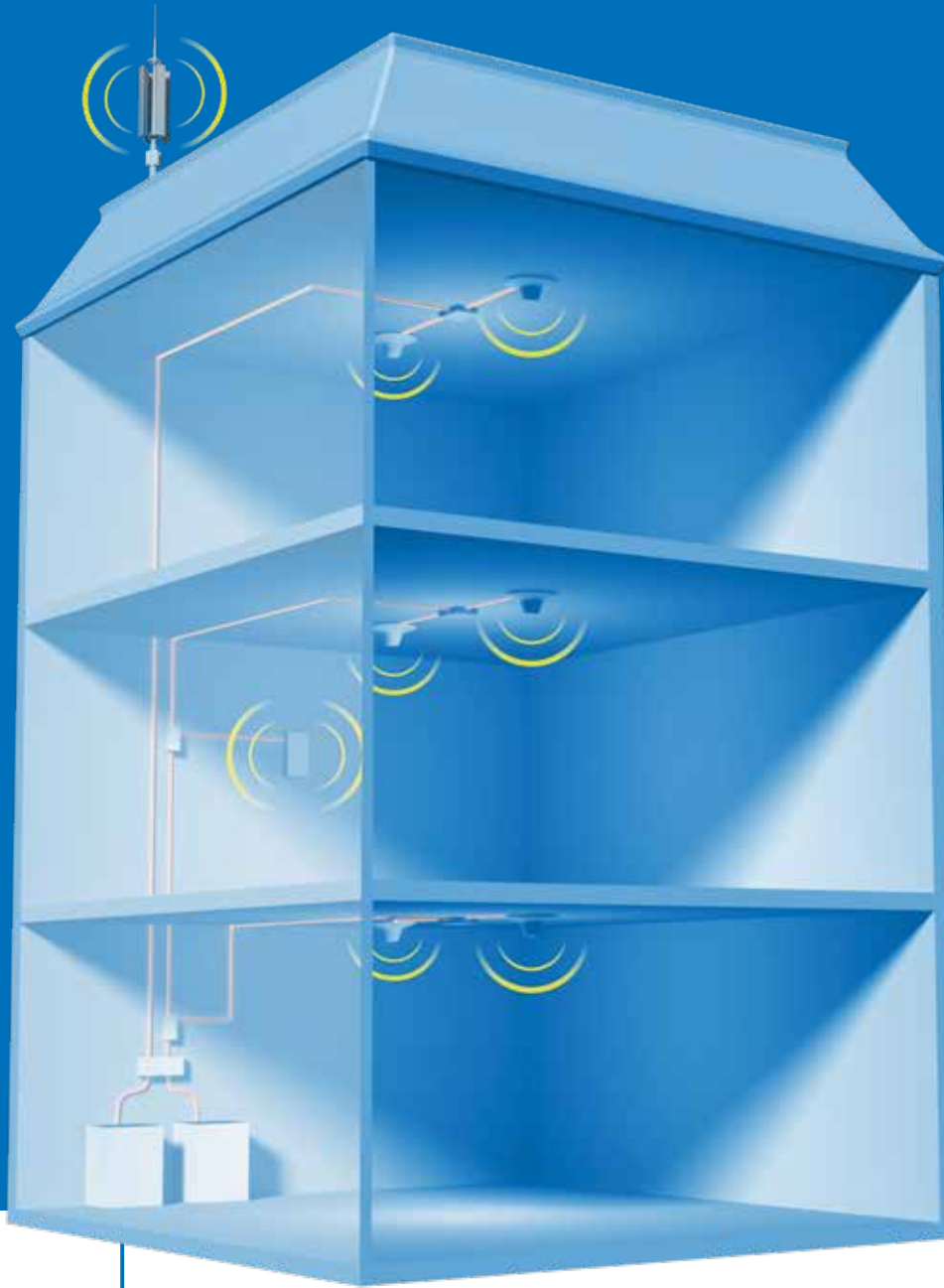

Power Splitter



Directional Coupler



Tapper



Hybrid Coupler

Telegärtner offers passive DAS components such as Power Splitters, Couplers, Tappers or Termination Loads to support its customers with suitable solutions. A broad range of coaxial RF components is available to cover the need for such products and to meet the heterogeneous requirements of each site. Due to the tendency of higher requirements regarding PIM levels, Telegärtner only offers

**low-PIM components ( $\leq -161$  dBc)** in the standard portfolio. Furthermore, future-proof components for **frequencies up to 3.8 GHz** are available for 5G applications. Due to the need for short delivery times, Telegärtner aims to be **ready for shipment within 24 hours for parts in stock**. Customized solutions are available on demand.

# POWER SPLITTERS

Power Splitters with N or 4.3-10 connector interfaces.

Power Splitters are used to split a signal equally from one input port through two, three or four output ports. All listed splitters are suitable for low-PIM applications due to the low PIM level of  $\leq -161$  dBc and are also characterized by high power capacity and low VSWR.

**low-PIM**

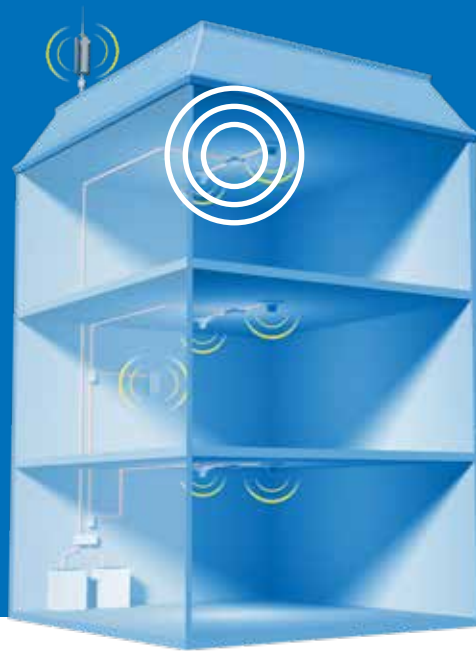

2-way, 3-way  
or 4-way splits

## Frequency Range

340–2700 MHz,  
698–2700 MHz,  
575–3800 MHz

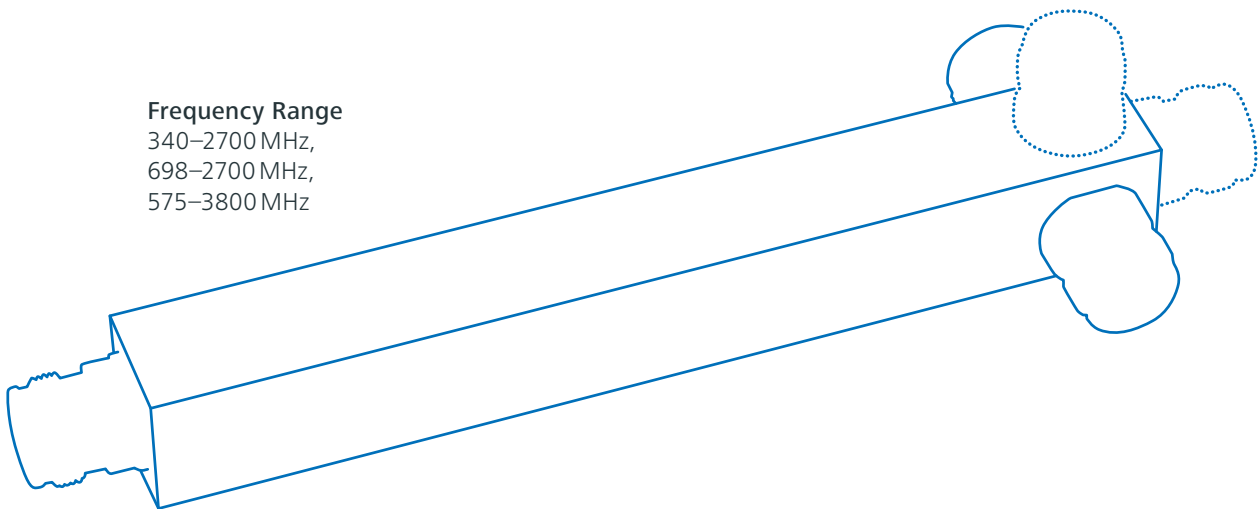

### N Connector Interface



J01029A0004

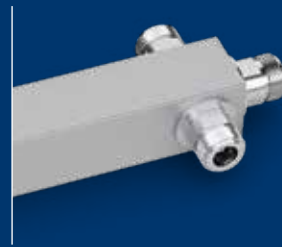

J01029A0005



J01029A0006

### 4.3-10 Connector Interface



J01447A0001



J01447A0002



J01447A0003

Part Number	Connector Interface	Frequency Range	Splits	Split Loss	PIM (@2 × 43 dBm)	Av. Power Rating	Environmental
J01029A0019	N female	340–2700 MHz	2-way	3 dB	≤ -161 dBc	200 W	IP65
J01029A0020	N female	340–2700 MHz	3-way	4.8 dB	≤ -161 dBc	200 W	IP65
J01029A0021	N female	340–2700 MHz	4-way	6 dB	≤ -161 dBc	200 W	IP65
J01029A0004	N female	698–2700 MHz	2-way	3 dB	≤ -161 dBc	200 W	IP65
J01029A0005	N female	698–2700 MHz	3-way	4.8 dB	≤ -161 dBc	200 W	IP65
J01029A0006	N female	698–2700 MHz	4-way	6 dB	≤ -161 dBc	200 W	IP65
J01029A0007	N female	575–3800 MHz	2-way	3 dB	≤ -161 dBc	200 W	IP65
J01029A0008	N female	575–3800 MHz	3-way	4.8 dB	≤ -161 dBc	200 W	IP65
J01029A0009	N female	575–3800 MHz	4-way	6 dB	≤ -161 dBc	200 W	IP65
J01447A0030	4.3-10 female	340–2700 MHz	2-way	3 dB	≤ -161 dBc	300 W	IP65
J01447A0031	4.3-10 female	340–2700 MHz	3-way	4.8 dB	≤ -161 dBc	300 W	IP65
J01447A0032	4.3-10 female	340–2700 MHz	4-way	6 dB	≤ -161 dBc	300 W	IP65
J01447A0001	4.3-10 female	698–2700 MHz	2-way	3 dB	≤ -161 dBc	300 W	IP65
J01447A0002	4.3-10 female	698–2700 MHz	3-way	4.8 dB	≤ -161 dBc	300 W	IP65
J01447A0003	4.3-10 female	698–2700 MHz	4-way	6 dB	≤ -161 dBc	300 W	IP65
J01447A0004	4.3-10 female	575–3800 MHz	2-way	3 dB	≤ -161 dBc	300 W	IP65
J01447A0005	4.3-10 female	575–3800 MHz	3-way	4.8 dB	≤ -161 dBc	300 W	IP65
J01447A0006	4.3-10 female	575–3800 MHz	4-way	6 dB	≤ -161 dBc	300 W	IP65

H06000A0084 L-Type Bracket for Splitters included

# DIRECTIONAL COUPLERS

Directional Couplers with N or 4.3-10 connector interfaces.

Directional Couplers can be used to split a signal into either two equal or into two unequal shares. This is provided with high isolation between the coupled and the output port. Directional couplers provide superior characteristics in terms of directivity and return loss. All listed directional couplers are suitable for low-PIM applications due to the low PIM level of  $\leq -161$  dBc.

**low-PIM**



J01024A0016

**Frequency Range**

340–2700 MHz,  
698–2700 MHz,  
575–3800 MHz

**Coupling Ratio  
up to 30 dB**



J01024A0017

Part Number	Connector Interface	Frequency Range	Coupling Ratio	PIM (@2 × 43 dBm)	Av. Power Rating	Environmental
J01024A0031	N female	340–2700 MHz	3 dB	≤ -161 dBc	200 W	IP65
J01024A0032	N female	340–2700 MHz	6 dB	≤ -161 dBc	200 W	IP65
J01024A0033	N female	340–2700 MHz	8 dB	≤ -161 dBc	200 W	IP65
J01024A0034	N female	340–2700 MHz	10 dB	≤ -161 dBc	200 W	IP65
J01024A0035	N female	340–2700 MHz	12 dB	≤ -161 dBc	200 W	IP65
J01024A0036	N female	340–2700 MHz	15 dB	≤ -161 dBc	200 W	IP65
J01024A0037	N female	340–2700 MHz	20 dB	≤ -161 dBc	200 W	IP65
J01024A0038	N female	340–2700 MHz	30 dB	≤ -161 dBc	200 W	IP65
J01024A0030	N female	698–2700 MHz	3 dB	≤ -161 dBc	200 W	IP65
J01024A0016	N female	698–2700 MHz	6 dB	≤ -161 dBc	200 W	IP65
J01024A0017	N female	698–2700 MHz	8 dB	≤ -161 dBc	200 W	IP65
J01024A0018	N female	698–2700 MHz	10 dB	≤ -161 dBc	200 W	IP65
J01024A0019	N female	698–2700 MHz	12 dB	≤ -161 dBc	200 W	IP65
J01024A0020	N female	698–2700 MHz	15 dB	≤ -161 dBc	200 W	IP65
J01024A0021	N female	698–2700 MHz	20 dB	≤ -161 dBc	200 W	IP65
J01024A0022	N female	698–2700 MHz	30 dB	≤ -161 dBc	200 W	IP65
J01024A0039	N female	575–3800 MHz	3 dB	≤ -161 dBc	200 W	IP65
J01024A0023	N female	575–3800 MHz	6 dB	≤ -161 dBc	200 W	IP65
J01024A0024	N female	575–3800 MHz	8 dB	≤ -161 dBc	200 W	IP65
J01024A0025	N female	575–3800 MHz	10 dB	≤ -161 dBc	200 W	IP65
J01024A0026	N female	575–3800 MHz	12 dB	≤ -161 dBc	200 W	IP65
J01024A0027	N female	575–3800 MHz	15 dB	≤ -161 dBc	200 W	IP65
J01024A0028	N female	575–3800 MHz	20 dB	≤ -161 dBc	200 W	IP65
J01024A0029	N female	575–3800 MHz	30 dB	≤ -161 dBc	200 W	IP65
J01447A0034	4.3-10 female	340–2700 MHz	3 dB	≤ -161 dBc	300 W	IP65
J01447A0035	4.3-10 female	340–2700 MHz	6 dB	≤ -161 dBc	300 W	IP65
J01447A0036	4.3-10 female	340–2700 MHz	8 dB	≤ -161 dBc	300 W	IP65
J01447A0037	4.3-10 female	340–2700 MHz	10 dB	≤ -161 dBc	300 W	IP65
J01447A0038	4.3-10 female	340–2700 MHz	12 dB	≤ -161 dBc	300 W	IP65
J01447A0039	4.3-10 female	340–2700 MHz	15 dB	≤ -161 dBc	300 W	IP65
J01447A0040	4.3-10 female	340–2700 MHz	20 dB	≤ -161 dBc	300 W	IP65
J01447A0041	4.3-10 female	340–2700 MHz	30 dB	≤ -161 dBc	300 W	IP65
J01447A0033	4.3-10 female	698–2700 MHz	3 dB	≤ -161 dBc	300 W	IP65
J01447A0007	4.3-10 female	698–2700 MHz	6 dB	≤ -161 dBc	300 W	IP65
J01447A0008	4.3-10 female	698–2700 MHz	8 dB	≤ -161 dBc	300 W	IP65
J01447A0009	4.3-10 female	698–2700 MHz	10 dB	≤ -161 dBc	300 W	IP65
J01447A0010	4.3-10 female	698–2700 MHz	12 dB	≤ -161 dBc	300 W	IP65
J01447A0011	4.3-10 female	698–2700 MHz	15 dB	≤ -161 dBc	300 W	IP65
J01447A0012	4.3-10 female	698–2700 MHz	20 dB	≤ -161 dBc	300 W	IP65
J01447A0013	4.3-10 female	698–2700 MHz	30 dB	≤ -161 dBc	300 W	IP65
J01447A0054	4.3-10 female	575–3800 MHz	3 dB	≤ -161 dBc	300 W	IP65
J01447A0014	4.3-10 female	575–3800 MHz	6 dB	≤ -161 dBc	300 W	IP65
J01447A0015	4.3-10 female	575–3800 MHz	8 dB	≤ -161 dBc	300 W	IP65
J01447A0016	4.3-10 female	575–3800 MHz	10 dB	≤ -161 dBc	300 W	IP65
J01447A0017	4.3-10 female	575–3800 MHz	12 dB	≤ -161 dBc	300 W	IP65
J01447A0018	4.3-10 female	575–3800 MHz	15 dB	≤ -161 dBc	300 W	IP65
J01447A0019	4.3-10 female	575–3800 MHz	20 dB	≤ -161 dBc	300 W	IP65
J01447A0020	4.3-10 female	575–3800 MHz	30 dB	≤ -161 dBc	300 W	IP65

# TAPPERS

Tappers with N or 4.3-10 connector interfaces.

Tappers are used to divide a signal into unequal parts respectively to tap off a signal portion from a main transmission line. Tappers are differentiated from couplers by being able to split signals only in defined ratios and without directivity. Tappers are generally smaller and less expensive than couplers, but also come with a low PIM level of  $\leq -161$  dBc and high power rating.

**low-PIM**



J01029A0012



## Frequency Range

340-960 MHz / 1710-2700 MHz or  
698-960 MHz / 1710-2700 MHz

Coupling Ratio  
up to 30 dB

J01447A0023





Part Number	Connector Interface	Frequency Range	Coupling Ratio	PIM (@2 x 43 dBm)	Av. Power Rating	Environmental
J01029A0026	N female	340–960 / 1710–2700 MHz	3 dB	≤ -161 dBc	200 W	IP65
J01029A0027	N female	340–960 / 1710–2700 MHz	6 dB	≤ -161 dBc	200 W	IP65
J01029A0028	N female	340–960 / 1710–2700 MHz	8 dB	≤ -161 dBc	200 W	IP65
J01029A0029	N female	340–960 / 1710–2700 MHz	10 dB	≤ -161 dBc	200 W	IP65
J01029A0030	N female	340–960 / 1710–2700 MHz	13 dB	≤ -161 dBc	200 W	IP65
J01029A0031	N female	340–960 / 1710–2700 MHz	15 dB	≤ -161 dBc	200 W	IP65
J01029A0032	N female	340–960 / 1710–2700 MHz	20 dB	≤ -161 dBc	200 W	IP65
J01029A0033	N female	340–960 / 1710–2700 MHz	30 dB	≤ -161 dBc	200 W	IP65
J01029A0025	N female	698–960 / 1710–2700 MHz	3 dB	≤ -161 dBc	200 W	IP65
J01029A0012	N female	698–960 / 1710–2700 MHz	6 dB	≤ -161 dBc	200 W	IP65
J01029A0013	N female	698–960 / 1710–2700 MHz	8 dB	≤ -161 dBc	200 W	IP65
J01029A0014	N female	698–960 / 1710–2700 MHz	10 dB	≤ -161 dBc	200 W	IP65
J01029A0015	N female	698–960 / 1710–2700 MHz	13 dB	≤ -161 dBc	200 W	IP65
J01029A0016	N female	698–960 / 1710–2700 MHz	15 dB	≤ -161 dBc	200 W	IP65
J01029A0017	N female	698–960 / 1710–2700 MHz	20 dB	≤ -161 dBc	200 W	IP65
J01029A0018	N female	698–960 / 1710–2700 MHz	30 dB	≤ -161 dBc	200 W	IP65
J01447A0045	4.3-10 female	340–960 / 1710–2700 MHz	3 dB	≤ -161 dBc	300 W	IP65
J01447A0046	4.3-10 female	340–960 / 1710–2700 MHz	6 dB	≤ -161 dBc	300 W	IP65
J01447A0047	4.3-10 female	340–960 / 1710–2700 MHz	8 dB	≤ -161 dBc	300 W	IP65
J01447A0048	4.3-10 female	340–960 / 1710–2700 MHz	10 dB	≤ -161 dBc	300 W	IP65
J01447A0049	4.3-10 female	340–960 / 1710–2700 MHz	13 dB	≤ -161 dBc	300 W	IP65
J01447A0050	4.3-10 female	340–960 / 1710–2700 MHz	15 dB	≤ -161 dBc	300 W	IP65
J01447A0051	4.3-10 female	340–960 / 1710–2700 MHz	20 dB	≤ -161 dBc	300 W	IP65
J01447A0052	4.3-10 female	340–960 / 1710–2700 MHz	30 dB	≤ -161 dBc	300 W	IP65
J01447A0053	4.3-10 female	698–960 / 1710–2700 MHz	3 dB	≤ -161 dBc	300 W	IP65
J01447A0023	4.3-10 female	698–960 / 1710–2700 MHz	6 dB	≤ -161 dBc	300 W	IP65
J01447A0024	4.3-10 female	698–960 / 1710–2700 MHz	8 dB	≤ -161 dBc	300 W	IP65
J01447A0025	4.3-10 female	698–960 / 1710–2700 MHz	10 dB	≤ -161 dBc	300 W	IP65
J01447A0026	4.3-10 female	698–960 / 1710–2700 MHz	13 dB	≤ -161 dBc	300 W	IP65
J01447A0027	4.3-10 female	698–960 / 1710–2700 MHz	15 dB	≤ -161 dBc	300 W	IP65
J01447A0028	4.3-10 female	698–960 / 1710–2700 MHz	20 dB	≤ -161 dBc	300 W	IP65
J01447A0029	4.3-10 female	698–960 / 1710–2700 MHz	30 dB	≤ -161 dBc	300 W	IP65
H06000A0085	W-Type Bracket for Tappers included					

# HYBRID COUPLERS

Hybrid Couplers with N or 4.3-10 connector interfaces.

Hybrid Couplers are basically used for either splitting a signal into equal shares with high port isolation or to combine signals within the same frequency band. As for most other components, Telegärtner concentrates on low PIM, low VSWR and low insertion loss.

**low-PIM**

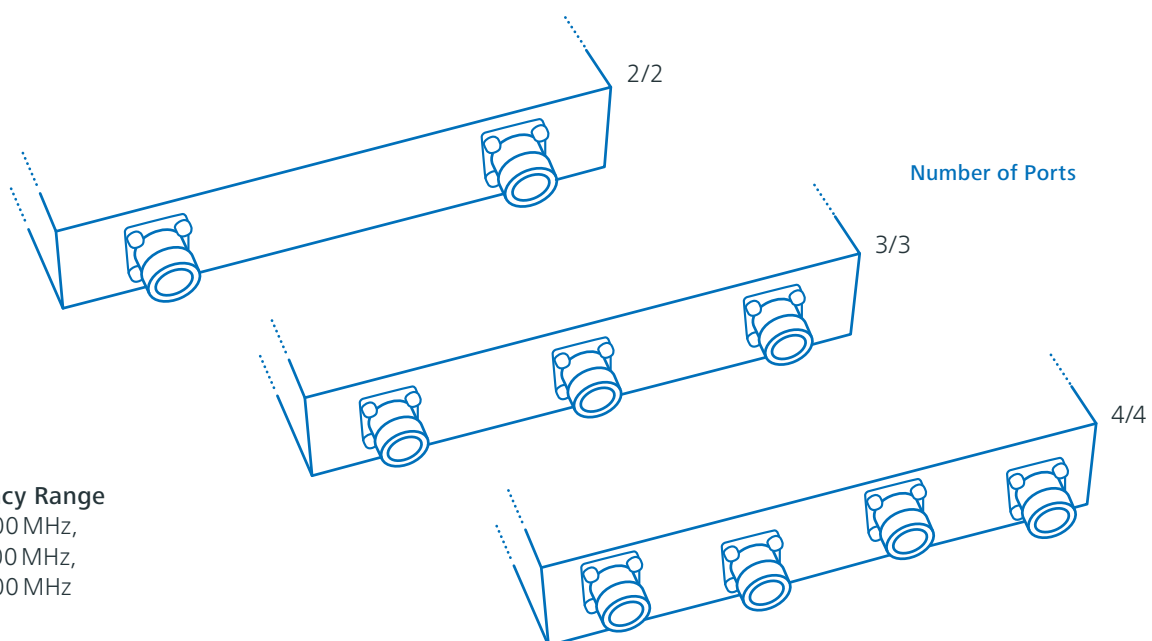

**Frequency Range**  
340–2700 MHz,  
698–2700 MHz,  
575–3800 MHz

Part Number	Connector Interface	Frequency Range	No. of Ports In/Out	PIM (@2 × 43 dBm)	Av. Power Rating	Environmental
J01029A0022	N female	340–2700 MHz	2/2	≤ -161 dBc	200 W	IP65
J01029A0010	N female	698–2700 MHz	2/2	≤ -161 dBc	200 W	IP65
J01029A0011	N female	575–3800 MHz	2/2	≤ -161 dBc	200 W	IP65
J01029A0023	N female	698–2700 MHz	3/3	≤ -155 dBc	200 W	IP65
J01029A0024	N female	698–2700 MHz	4/4	≤ -161 dBc	200 W	IP65
J01447A0042	4.3-10 female	340–2700 MHz	2/2	≤ -161 dBc	300 W	IP65
J01447A0021	4.3-10 female	698–2700 MHz	2/2	≤ -161 dBc	300 W	IP65
J01447A0022	4.3-10 female	575–3800 MHz	2/2	≤ -161 dBc	300 W	IP65
J01447A0043	4.3-10 female	698–2700 MHz	3/3	≤ -155 dBc	300 W	IP65
J01447A0044	4.3-10 female	698–2700 MHz	4/4	≤ -161 dBc	300 W	IP65

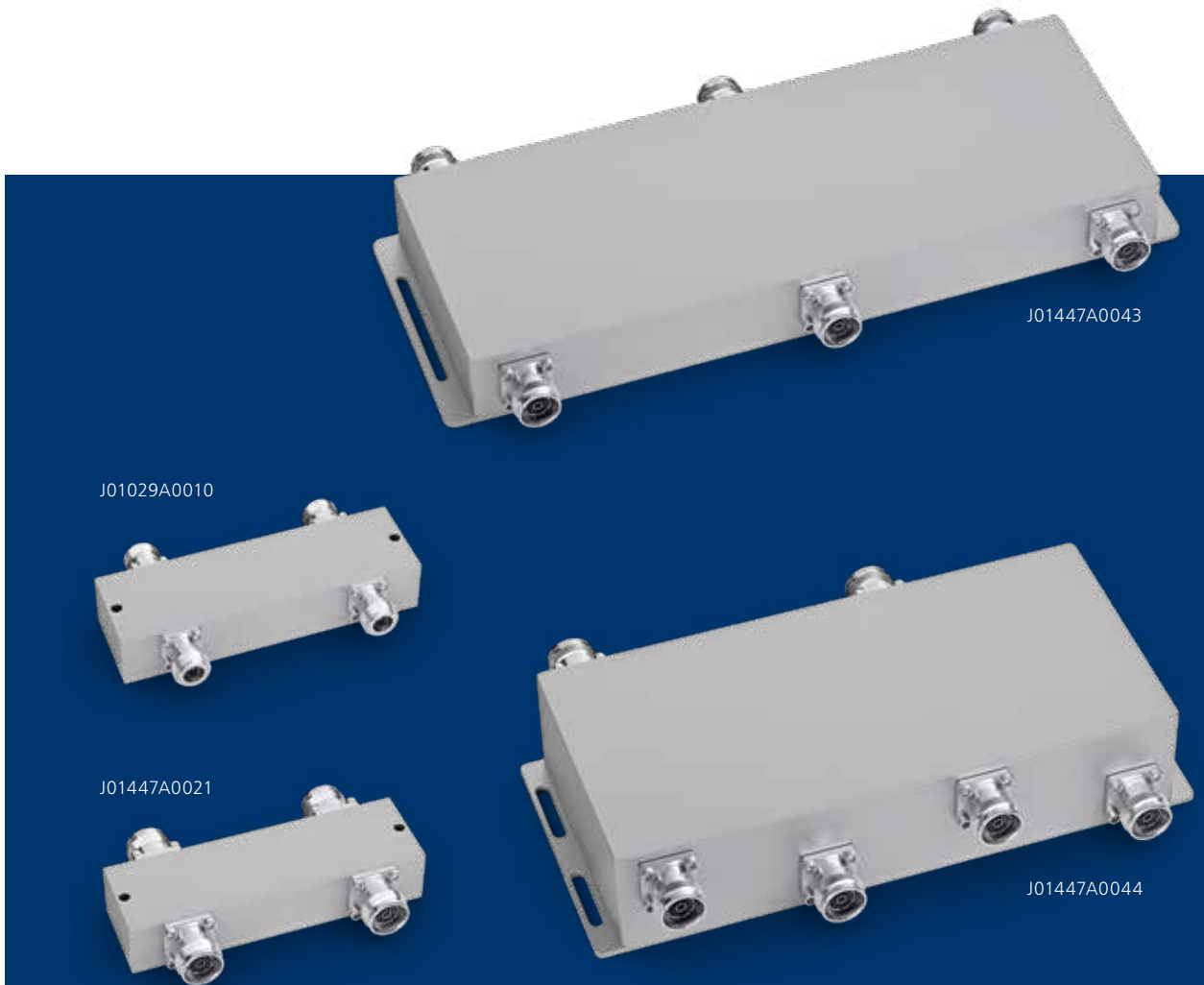

# TERMINATION LOADS

Termination Loads with N or 4.3-10 connector interfaces.

Termination Loads are applied to terminate remaining power on a transmission line that is not needed, e.g. for testing purposes or diagnostics. The target is also not to reflect any power. Loads can likewise be used to terminate an unused port of a hybrid couplers when it is used as directional coupler. Besides standard loads, Telegärtner also offers low-PIM Loads with 4.3-10 plugs for terminating power up to 200 W.

**low-PIM**

J01444A0004

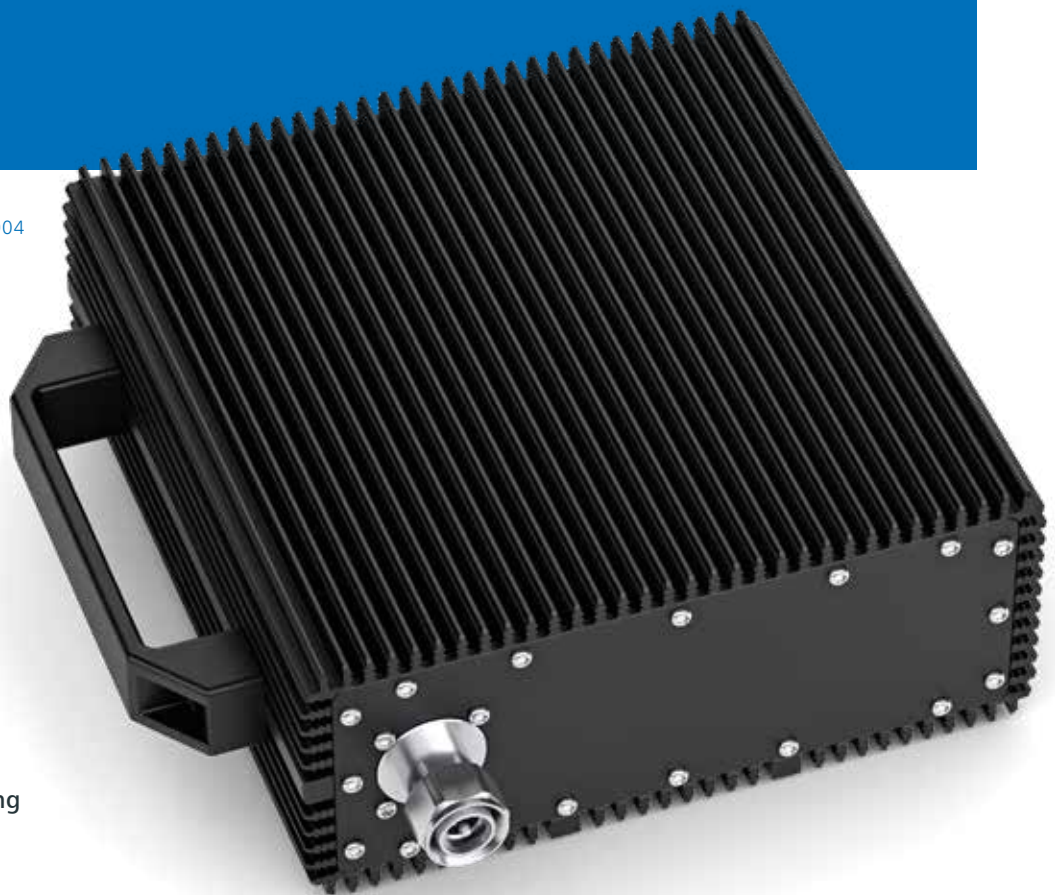

4.3-10 low-PIM versions  
up to 200W Power Rating



J01444A0003

J01026A0022

J01444A0000

Part Number	Connector Interface	Frequency Range	Power Rating	PIM (@2 × 43 dBm)
J01026A0012	N male	0–6 GHz	1 W	–
J01026A0010	N male	0–18 GHz	2 W	–
J01026A0022	N male	0–6 GHz	10 W	–
J01444A0001	4.3-10 male	0–6 GHz	1 W	–
J01444A0000	4.3-10 male (Screw)	0–7.5 GHz	2 W	–
J01444A3000	4.3-10 male (Push-Pull)	0–7.5 GHz	2 W	–
J01444A0002	4.3-10 male	0–6 GHz	10 W	–
J01444A0011	4.3-10 male	650–3000 MHz	10 W	≤ -161 dBc
J01444A0003	4.3-10 male	650–3000 MHz	30 W	≤ -161 dBc
J01444A0004	4.3-10 male	698–2700 MHz	200 W	≤ -161 dBc
H06000A0083	Bracket for High Power Low PIM Loads & Attenuators			

# ATTENUATORS

Attenuators with N or 4.3-10 connector interfaces.

Attenuators are used where power needs to be reduced to reach a certain transmitted power level at a defined point in a transmission line. Attenuators can virtually simulate longer transmission distances with the same insertion loss. Besides standard attenuators, Telegärtner also offers low-PIM attenuators ( $\leq -161$  dBc) with 4.3-10 interface for higher power up to 100 W and attenuation up to 30 dB.

**low-PIM**

J01444A0008

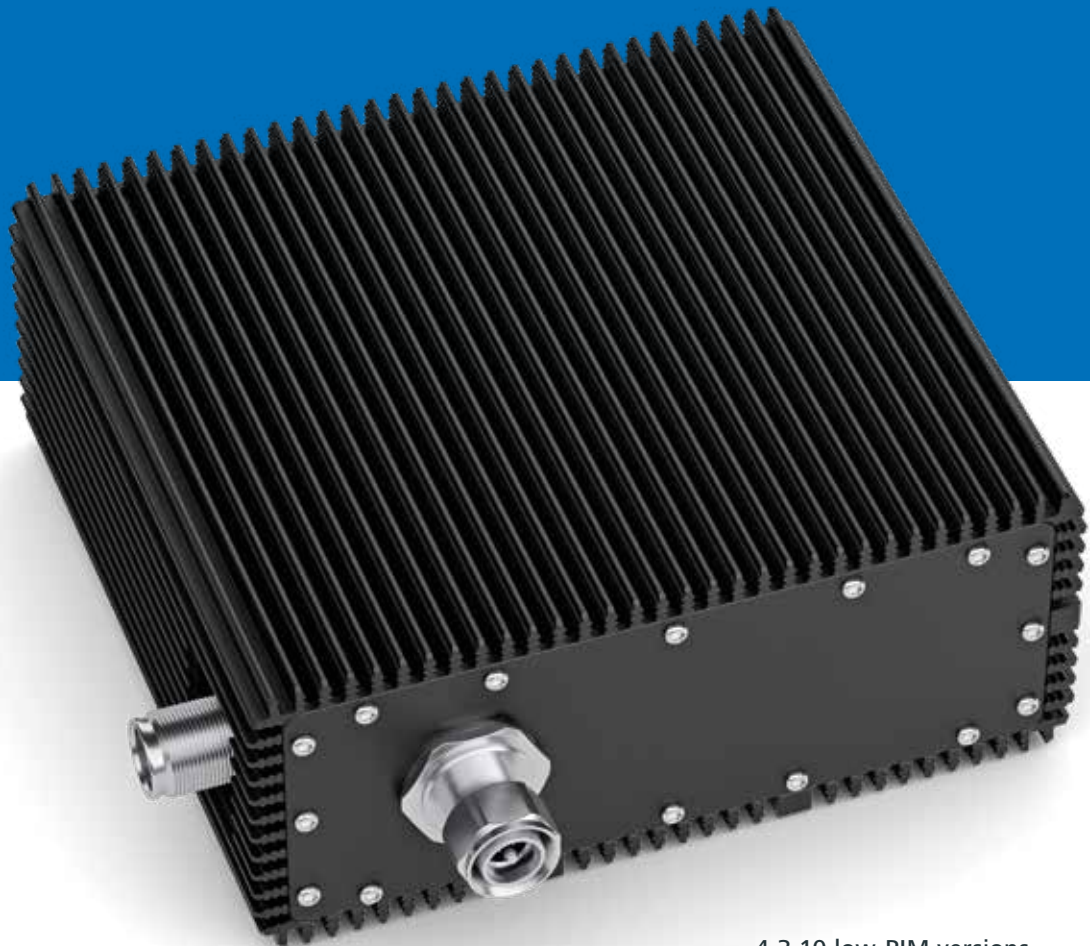

Attenuation  
up to 30 dB

4.3-10 low-PIM versions  
up to 100 W Power Rating



J01026A0020

Part Number	Connector Interface	Frequency Range	Power Rating	Attenuation	PIM (@2 × 43 dBm)
J01026A0018	N male to N female	0–10 GHz	2 W	3 dB	–
J01026A0019	N male to N female	0–10 GHz	2 W	6 dB	–
J01026A0020	N male to N female	0–10 GHz	2 W	10 dB	–
J01026A0021	N male to N female	0–10 GHz	2 W	20 dB	–
J01444A0005	4.3-10 male to 4.3-10 female	698–2700 MHz	50 W	10 dB	≤ -161 dBc
J01444A0006	4.3-10 male to 4.3-10 female	698–2700 MHz	50 W	20 dB	≤ -161 dBc
J01444A0007	4.3-10 male to 4.3-10 female	698–2700 MHz	50 W	30 dB	≤ -161 dBc
J01444A0008	4.3-10 male to 4.3-10 female	698–2700 MHz	100 W	10 dB	≤ -161 dBc
J01444A0009	4.3-10 male to 4.3-10 female	698–2700 MHz	100 W	20 dB	≤ -161 dBc
J01444A0010	4.3-10 male to 4.3-10 female	698–2700 MHz	100 W	30 dB	≤ -161 dBc
H06000A0083	Bracket for High Power Low PIM Loads & Attenuators				

Telegärtner  
Karl Gärtner GmbH

Lerchenstr. 35  
D-71144 Steinenbronn

Tel. +49 71 57/1 25-0  
Fax +49 71 57/1 25-5120

info@telegaertner.com  
www.telegaertner.com

**Would you like to discover our entire  
portfolio for Antenna Line Products?**

Please have a look at our catalogue „Components  
for Mobile Communication Networks“ on our  
website [www.telegaertner.com/go/MCS](http://www.telegaertner.com/go/MCS)

Your distributor: