

# Beta *Action* 2026



**INDUSTRIA E ARTIGIANATO**

SEGUICI SU  
INSTAGRAM!





**ARREDO OFFICINA  
C45PRO 2.0 - RCS50 2.0**

**2÷7**



**CASSETTIERE MOBILI**

**8÷12**



**ASSORTIMENTI E MODULI**

**13÷16**



**BANCHI**

**17-18**



**CARRELLI E TRANSPALLET**

**12-18-19**



**CONTENITORI**

**20÷23**



**CHIAVI DI MANOVRA**

**24÷28**



**UTENSILI COLOR CODE**

**29**



**GIRAVITE**

**30-31**



**INSERTI E BUSSOLE**

**32÷35**



**DINAMOMETRIA**

**36÷39**



**PINZE**

**40÷42**



**MARTELLI E SCALPELLI**

**43**



**FORARE E FILETTARE**

**44-45**



**POWER TOOLS E ABRASIVI**

**46-47**



**IDRAULICA**

**48**



**MANUTENZIONE GENERALE**

**49**



**ILLUMINAZIONE**

**50÷53**



**MISURARE**

**54-55**



**ELETTROTECNICA**

**56**



**PRODOTTI ELETTRICI**

**56-57**



**TAGLIARE**

**58÷60**



**UTENSILI ISOLATI**

**61**

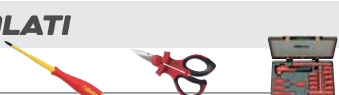

**UTENSILI INOX**

**62**



**BETA CHEMICALS**

**63**



**AVVOLGITORI**

**64-65**



**ESTRARRE**

**66**



**AUTOMOTIVE**

**67÷69**



**ROBUR**

**70÷73**



**UTENSILI PNEUMATICI**

**74÷79**



**CALZATURE DI SICUREZZA**

**80÷87**



**ABBIGLIAMENTO DA LAVORO**

**88÷96**



**BETA COLLECTION**

**97**

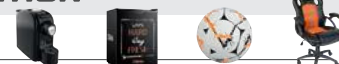

Articoli in confezione appendibile

**NEW**

# ACQUISTA LA COMBINAZIONE C45PRO

COMBINAZIONE C45PRO: PIANO DI LAVORO DA **46 cm**

**C45PRO X/196UT**

305 kg

045001987

**Combinazione arredo officina C45PRO composta da:**

- Piano di lavoro in MDF rivestito in acciaio inossidabile dimensioni 2.040x**463** mm (C45PX/3-2,0MT)
- Modulo fisso con 7 cassetti (C45PRO M7)
- Cassettiera mobile con 7 cassetti (C45PRO C7)
- Modulo fisso di servizio (C45PRO MS)
- 3 pannelli forati portautensili (C45PRO PF)
- 3 pensili a muro (C45PRO PM)
- 3 staffe per parete tipo largo (C45PRO SL)
- 1 staffa per parete tipo stretto (C45PRO SS)
- Armadio a 2 ante (C45PRO AS2)

2000 mm  
495 mm  
2955 mm



ASSORTIMENTO DI **196** UTENSILI **Beta**  
WORKER



36

MMC45-V1 BW



137

MMC45-V2N BW

14"

12"

NUOVO CRICCHETTO **Beta**



23

MMC45-V3 BW

SCOPRI L'ASSORTIMENTO



NEL DETTAGLIO!

€ 6.940,00

€ 2.590,00



Risparmi

€ 420,00

dei prodotti scelti

**NEW**

# ...CON L'ASSORTIMENTO PIÙ ADATTO ALLE TUE ESIGENZE

## COMBINAZIONE C45PRO 2.0: PIANO DI LAVORO DA **61,5 cm**

### C45PRO 2.0 X/268UT

334 kg 045009158

- 1 piano di lavoro in MDF rivestito in acciaio inossidabile, dimensioni 2.040x615 mm (C45PRO 2.0 PXE/3-2,0MT)

### C45PRO 2.0 W/268UT

318 kg 045009159

- 1 piano di lavoro in legno multistrato, dimensioni 2.040x615 mm (C45PRO 2.0 PWE/3-2,0MT)

#### Combinazione arredo officina C45PRO 2.0 composta da:

- Modulo fisso con 7 cassetti (C45PRO 2.0 M7)
- Cassettiera mobile con 7 cassetti (C45PRO 2.0 C7)
- Modulo fisso di servizio (C45PRO 2.0 MS)
- 3 pannelli forati portautensili (C45PRO 2.0 PF)
- 3 pensili a muro (C45PRO 2.0 PM)
- 3 staffe per parete tipo largo (C45PRO 2.0 SL)
- 1 staffa per parete tipo stretto (C45PRO 2.0 SS)
- Armadio a 2 ante (C45PRO 2.0 AS2)

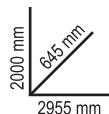

## ASSORTIMENTO DI 268 UTENSILI WORKER



MM-1 BW



MM-2 BW



MM-3 BW



MM-4/N BW



MM-5 BW

 NUOVO CRICCHETTO 

SCOPRI L'ASSORTIMENTO



NEL DETTAGLIO!

~~€ 8.380,00~~  
**€ 2.990,00**

**Risparmi**  
**€ 850,00**



i dei prodotti scolti

**NEW**

ACQUISTA LA COMBINAZIONE **C45PRO 2.0**

PIANO DI LAVORO DA **61,5 cm**

**C45PRO 2.0 B7X/196UT**

**211 kg** 045009155

- 1 piano di lavoro in **MDF rivestito in acciaio inossidabile**, dimensioni 1.360x**615** mm (C45PRO 2.0 PXE/2-1,3MT)

**C45PRO 2.0 B7W/196UT**

**201 kg** 045009156

- 1 piano di lavoro in **legno multistrato**, dimensioni 1.360x**615** mm (C45PRO 2.0 PWE/2-1,3MT)

**Combinazione arredo officina C45PRO 2.0 composta da:**

- Modulo fisso con 7 cassetti (C45PRO 2.0 M7)
- Modulo fisso con 2 antine (C45PRO 2.0 MA)
- 2 pensili a muro (C45PRO 2.0 PM)
- 2 pannelli forati portautensili (C45PRO 2.0 PF)
- 2 staffe per parete tipo largo (C45PRO 2.0 SL)
- 1 staffa per parete tipo stretto (C45PRO 2.0 SS)
- Armadio ad 1 anta (C45PRO 2.0 AS1)

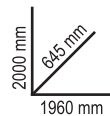

ASSORTIMENTO DI **196** UTENSILI **Beta**  
WORKER



MMC45-V1 BW

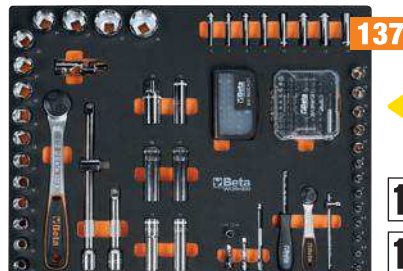

MMC45-V2N BW



MMC45-V3 BW

NUOVO CRICCHETTO **Beta**

14"

12"

SCOPRI L'ASSORTIMENTO



NEL DETTAGLIO!

~~€ 5.310,00~~

**€ 1.999,00**



Risparmi

**€ 311,00**

dei prodotti scelti

**NEW**

# ...CON L'ASSORTIMENTO PIÙ ADATTO ALLE TUE ESIGENZE

## PIANO DI LAVORO DA **61,5 cm**

### C45PRO 2.0 AX/157UT

 **234,5 kg**
 **045009167**

- 1 piano di lavoro in MDF rivestito in acciaio inossidabile, dimensioni 2.040x615 mm (C45PRO 2.0 PXE/3-2,0MT)

### C45PRO 2.0 AW/157UT

 **219 kg**
 **045009168**

- 1 piano di lavoro in legno multistrato, dimensioni 2.040x615 mm (C45PRO 2.0 PWE/3-2,0MT)

#### Combinazione arredo officina C45PRO 2.0 composta da:

- Modulo fisso di servizio (C45PRO 2.0 MS)
- Modulo fisso con 7 cassetti (C45PRO 2.0 M7)
- Modulo fisso con 2 antine (C45PRO 2.0 MA)
- 3 pensili a muro (C45PRO 2.0 PM)
- 3 pannelli forati portautensili (C45PRO 2.0 PF)
- 2 staffe per parete tipo largo (C45PRO 2.0 SL)
- 2 staffe per parete tipo stretto (C45PRO 2.0 SS)

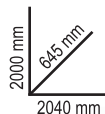

2000 mm  
615 mm  
2040 mm



## ASSORTIMENTO DI **157** UTENSILI **Beta** WORKER

### ACCESSORI DI FISSAGGIO INCLUSI

SCOPRI  
L'ASSORTIMENTO



NEL DETTAGLIO!

~~€ 5.470,00~~  
**€ 2.290,00**

**Risparmi**  
**€ 269,00**



NUOVO CRICCHETTO  **Beta**



**NEW**

# ACQUISTA LA COMBINAZIONE RSC50 2.0

PIANO DI LAVORO DA **70 cm**

## RSC50 2.0 D/224UT

**276 kg**    **050001090**

- Piano di lavoro in lamiera verniciata da 1.495x700 mm (RSC50 2.0 NPG/2-1,5MT)

## RSC50 2.0 DX/224UT

**275 kg**    **050001080**

- Piano di lavoro in MDF rivestito in acciaio inossidabile da 1.495x700 mm (RSC50 2.0 PX/2-1,5MT)

## RSC50 2.0 DW/224UT

**263 kg**    **050001081**

- Piano di lavoro in legno multistrato da 1.495x700 mm (RSC50 2.0 PW/2-1,5MT)

### Combinazione arredo officina RSC50 2.0 composta da:

- 1 Modulo fisso con 7 cassetti (RSC50 2.0 M7)
- 1 Modulo fisso con 2 antine (RSC50 2.0 MA)
- 2 pensili a muro (RSC50 2.0 PM)
- 2 pannelli forati portautensili superiori (RSC50 2.0 PFS)
- 2 pannelli forati portautensili inferiori (RSC50 2.0 PFI)
- 2 coppie montanti DX-SX (RSC50 2.0 P/2MDX-SX)
- 1 Armadio ad 1 anta (RSC50 2.0 A1)

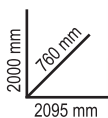

SCOPRI DI PIÙ



## ASSORTIMENTO DI 224 UTENSILI **Beta**



M391



M392



M394MH



M397MH



SCOPRI L'ASSORTIMENTO  
NEL DETTAGLIO!

~~€ 9.530,00~~

**€ 3.590,00**



**Risparmi**

**€ 1.199,00**

...dei prodotti scelti

**NEW**

# ...CON L'ASSORTIMENTO PIÙ ADATTO ALLE TUE ESIGENZE

 PIANO DI LAVORO DA **70 cm**
**RSC50 2.0 F/411UT**

411 kg 050001095

- Piano di lavoro in lamiera verniciata da 2.240x700 mm (RSC50 2.0 NPG/3-2,2MT)

**RSC50 2.0 FX/411UT**

405 kg 050001097

- Piano di lavoro in MDF rivestito in acciaio inossidabile da 2.240x700 mm (RSC50 2.0 PX/3-2,2MT)

**RSC50 2.0 FW/411UT**

386 kg 050001098

- Piano di lavoro in legno multistrato da 2.240x700 mm (RSC50 2.0 PW/3-2,2MT)

 2000 mm  
760 mm  
3155 mm

**Combinazione arredo officina RSC50 2.0 composta da:**

- 1 Modulo fisso con 7 cassetti (RSC50 2.0 M7)
- 1 Cassettiera mobile con 7 cassetti (RSC50 2.0 C7)
- 1 Modulo fisso di servizio con 2 cassetti (RSC50 2.0 MS-2C)
- 3 pensili a muro (RSC50 2.0 PM)
- 3 pannelli forati portautensili superiori (RSC50 2.0 PFS)
- 3 pannelli forati portautensili inferiori (RSC50 2.0 PFI)
- 3 coppie montanti DX-SX (RSC50 2.0 P/2MDX-SX)
- 1 Armadio a 2 ante (RSC50 2.0 A2)

**ASSORTIMENTO DI 411 UTENSILI Beta**

M25



M105MH

14" 38" 12"



M169



M245MH



M238



M320

**TRAPANO AVVITATORE 20V 1972/K20V-13BMC**
~~€ 16.180,00~~
**€ 5.970,00**

**Risparmi**
**€ 1.899,00**

SCOPRI L'ASSORTIMENTO



sui prodotti scelti

# GAMMA RSC

## L'EVOLUZIONE DELLA PERFEZIONE

SCOPRI DI PIÙ



### RSC24

Cassettiera mobile porta attrezzi, vuota

- Piano di lavoro rinforzato in ABS, solido e robusto
- Piano di appoggio multifunzione con bordi anticaduta e 8 fori per l'alloggiamento dei giravite
- 4 ruote Ø 125 mm di cui 2 fisse e 2 girevoli (una con freno)
- Serratura di sicurezza centralizzata frontale
- Porta flaconi laterale integrato, applicabile su entrambi i lati
- Piano dei cassetti protetto da tappetini di gomma espansa
- Possibilità di inserire in ogni cassetto  
fino a 4 vassoi morbidi in EVA  
o termoformati rigidi in ABS

Accessori integrabili disponibili a listino.

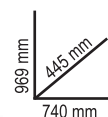

	kg	Ral 2011 Ral 7016	Ral 3000 Ral 7016	Ral 7016	Ral 2011	Ral 9006 Ral 7016	Ral 5015 Ral 7016	Ral 9005	€
<b>RSC24/7</b>	63	024004071	024004073	024004077	024004070	024004072	024004076	024004079	<del>€ 1.132,00</del> <b>€ 629,00</b>
<b>RSC24/5</b>	60	024004051	024004053	024004057	<del>€ 977,00</del> <b>€ 529,00</b>				
<b>RSC24/6</b>	62	024004061	024004063	024004067	<del>€ 1.053,00</del> <b>€ 589,00</b>				
<b>RSC24/8</b>	66	024004081	024004083	024004087	<del>€ 1.225,00</del> <b>€ 685,00</b>				

RSC24/7		
n°	mm	kg Max
5	70 mm	25 kg
1	140 mm	30 kg
1	210 mm	30 kg

RSC24/5		
n°	mm	kg Max
2	70 mm	25 kg
2	140 mm	30 kg
1	280 mm	35 kg

RSC24/6		
n°	mm	kg Max
4	70 mm	25 kg
1	140 mm	30 kg
1	280 mm	35 kg

RSC24/8		
n°	mm	kg Max
6	70 mm	25 kg
2	140 mm	30 kg



### 2400 RSC24/KA4

024004884

Kit accessori per cassettiere mobili  
RSC24, RSC24A e RSC51

Composto da:

- Pannello forato portautensili **2400 RSC24/PF**
- Mensola pieghevole **2400 RSC24/MP**
- Porta documenti **2400 RSC24/PD-A**
- Portacarta per rotoli preforati **2400 RSC24/PC-A**

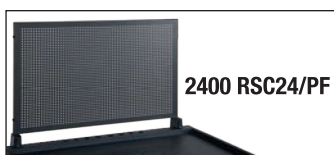

~~€ 257,00~~  
**€ 149,00**

**NEW**

ACQUISTA L'ASSORTIMENTO DI UTENSILI **Beta** PIÙ ADATTO ALLE TUE ESIGENZE

**LA CASSETTIERA RSC24 È INCLUSA NEL PREZZO!**



**Risparmi fino a € 3.700,00**

## 2400 RSC24/7-VIS

Assortimento **224** utensili INDUSTRIA 1/4" 12"



M391



M392



M394MH



M397MH

~~€ 3.250,00~~  
**€ 1.299,00**

**Versione medium**

Cassettera RSC24/7 € 1.132,00 + Assortimento 224 utensili Industria € 2.115,00 = ~~€ 3.247,00~~  
sconto € 1.948,00 (pari al -60%) **Totale € 1.299,00**



**INCLUSA la cassettera mobile RSC24/7**



2400 RSC24/7-VIS/FO  
024004037



**NEW**  
2400 RSC24/7-VIS/A  
024004036

## 2400 RSC24A/8-VIL

Assortimento **411** utensili INDUSTRIA 1/4" 3/8" 12"



M25



M105MH



M169



M245MH



M34



M146

~~€ 5.720,00~~  
**€ 1.999,00**

**Versione extra large**

Cassettera RSC24A/8 € 1.355,00 + Assortimento 411 utensili Industria € 4.360,00 = ~~€ 5.715,00~~  
sconto € 3.716,00 (pari al -65%) **Totale € 1.999,00**

**L'ASSORTIMENTO BETA PIÙ COMPLETO DI SEMPRE**



**INCLUSA la cassettera mobile con sistema antiribaltamento RSC24A/8**



2400 RSC24A/8-VIL/O



**NEW**  
2400 RSC24A/8-VIL/A

**RSC24AXLP/7**

105 kg

**Cassettiera mobile 7 cassetti con piano di lavoro in legno e SISTEMA ANTIRIBALTAMENTO, modello lungo, vuota**

- 7 cassetti da 882x367 mm ad estrazione totale, montati su guide telescopiche a sfera
- **Piano di lavoro in legno multistrato** con fori per la collocazione di una morsa 1599F/100 o 1599GI/100 (da ordinare separatamente)
- Frontalino in nylon ad alta resistenza, con porta-etichette integrato
- Piano dei cassetti protetto da tappetini di gomma espansa
- Quattro ruote Ø 125 mm di cui 2 fisse e 2 girevoli (una con freno)
- Serratura di sicurezza centralizzata frontale
- Portacarta integrato
- Portaflaconi laterale integrato (applicabile su entrambi i lati)
- Possibilità di inserire in ogni cassetto **fino a 6 vassoi morbidi in EVA o termoformati rigidi in ABS**

*Accessori integrabili disponibili a listino.*

n°	Max
5	70 mm 30 kg
1	140 mm 35 kg
1	210 mm 35 kg

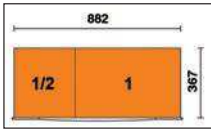

Ral 2011	Ral 3000	Ral 7016
Ral 7016	Ral 7016	Ral 7016
024004571	024004573	024004577

€ 1.830,00  
**€ 1.025,00**

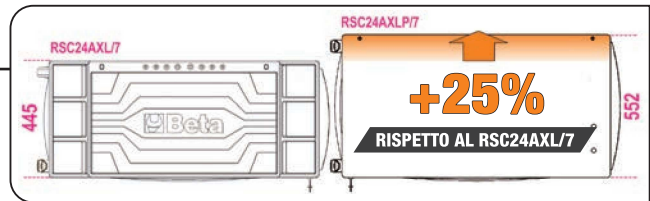

**ACCESSORI E UTENSILI NON INCLUSI**

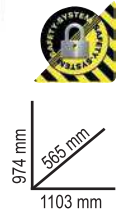

**RSC24L-CAB**

82 kg

**Cassettiera porta attrezzi con 7 cassetti e ARMADIETTO PORTAOGGETTI**

- 7 cassetti da 588x367 mm, montati su guide telescopiche a sfera
- Piano dei cassetti protetto da tappetini di gomma espansa
- Quattro ruote Ø 125 mm di cui 2 fisse e 2 girevoli con freno
- Serratura centralizzata frontale
- **Armadietto laterale portaoggetti con anta richiudibile con serratura e ripiano interno regolabile in altezza**
- Piano di lavoro in legno multistrato con fori per la collocazione di una morsa 1599F/100 - 1599GI/100 (da ordinare separatamente)
- Portacarta integrato
- Doppio portaflaconi posteriore



Ral 2011	Ral 3000	Ral 7016
Ral 7016	Ral 7016	Ral 7016
024004474	024004473	024004477

€ 1.775,00  
**€ 995,00**

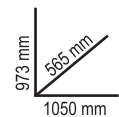

n°	Max
5	70 mm 25 kg
1	140 mm 30 kg
1	210 mm 35 kg

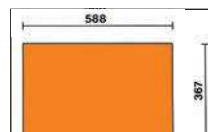

## RSC24AXL

### Cassettiera porta attrezzi CON SISTEMA ANTIRIBALTAMENTO, modello lungo

- Piano di lavoro rinforzato in ABS con bordi anticaduta, 8 fori per l'alloggiamento dei giravite e 6 vaschette portaminuterie
- **Frontalino in nylon ad alta resistenza, con porta-etichette integrato**
- Piano dei cassetti protetto da tappetini di gomma espansa
- Quattro ruote Ø 125 mm di cui 2 fisse e 2 girevoli (una con freno)
- Serratura di sicurezza centralizzata frontale
- Portaflaconi laterale integrato (applicabile su entrambi i lati)
- Possibilità di inserire in ogni cassetto **fino a 6 vassoi morbidi in EVA o termoformati rigidi in ABS**

Accessori integrabili disponibili a listino.

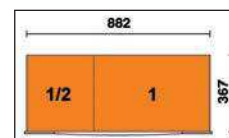
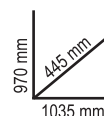

	Ral 2011 Ral 7016	Ral 3000 Ral 7016	Ral 7016	n°	↓ max	kg	€
<b>RSC24AXL/7</b>	024004271	024004273	024004277	5	70 mm	30 kg	<del>€ 1.590,00</del> <b>€ 899,00</b>
				1	140 mm	35 kg	
				1	210 mm	35 kg	
<b>RSC24AXL/8</b>	024004281	024004283	024004287	6	70 mm	30 kg	<del>€ 1.705,00</del> <b>€ 965,00</b>
				2	140 mm	35 kg	
<b>RSC24AXL/9</b>	024004291	024004293	024004297	8	70 mm	30 kg	<del>€ 1.815,00</del> <b>€ 1.025,00</b>
				1	140 mm	35 kg	

## RSC24AXXL

### Cassettiera mobile con 8 cassetti e SISTEMA ANTIRIBALTAMENTO, modello lungo

- 1 cassetto da 1.176x367 mm ad estrazione totale, montato su guide telescopiche a sfera
- 7 cassetti da 882x367 mm ad estrazione totale, montati su guide telescopiche a sfera:  
6 cassetti altezza 70 mm  
1 cassetto altezza 140 mm
- **Piano di lavoro in MDF rivestito in acciaio inossidabile** con fori per la collocazione di una morsa 1599F/125 o 1599GI/125 (da ordinare separatamente) e 6 vaschette portaminuteria
- Frontalini in nylon ad alta resistenza, con porta-etichette integrato
- Piano dei cassetti protetto da tappetini di gomma espansa
- Vano laterale estraibile, montato su guide telescopiche a sfera, con ripiano e serratura
- Quattro ruote Ø 150 mm di cui 2 fisse e 2 girevoli con freno
- 3 serrature di sicurezza
- Portacarta integrato
- Portaflaconi integrato
- Possibilità di inserire: **fino a 8 vassoi morbidi in EVA o termoformati rigidi in ABS** nel cassetto da 1.176x367 mm **fino a 6 vassoi morbidi in EVA o termoformati rigidi in ABS** nel cassetto da 882x367 mm

Accessori integrabili disponibili a listino.



Ral 2011	Ral 3000	Ral 7016
024004781	024004783	024004787

€ 2.265,00  
**€ 1.285,00**

### LA TUA POSTAZIONE DI LAVORO SU RUOTE

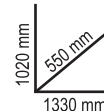

SCOPRI DI PIÙ



n°	Max
1	70 mm (1.176x367 mm) 40 kg
6	70 mm (882x367 mm) 30 kg
1	140 mm (882x367 mm) 35 kg

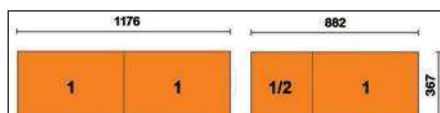

RSC28

1200 kg

130 kg

**Carrello SuperTank con piano di lavoro in legno e 10 cassetti**

- 10 cassetti da 588x367 mm, montati su guide telescopiche a sfera
- Sistema rapido e sicuro per l'apertura e chiusura dei cassetti con frontalino in nylon e fibra di vetro
- Piano dei cassetti protetto da tappetini di gomma espansa
- Quattro ruote ad alta portata Ø 150 mm di cui 2 fisse e 2 girevoli con freno
- 2 serrature di sicurezza centralizzate
- Piano di lavoro in legno multistrato con fori per la collocazione di una morsa 1599F/150 - 1599GI/150 (da ordinare separatamente)
- Portaflaconi integrati
- Vano laterale con antina di chiusura a scomparsa con serratura
- Vano passante altezza 135 mm con base ricoperta in materiale plastico

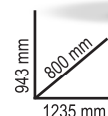

Ral 2011	Ral 3000	Ral 7016
Ral 7016	Ral 7016	Ral 7016
028003001	028003003	028003007

€ 3.120,00  
**€ 1.725,00**

n°	mm	Max
8	70 mm	25 kg
2	210 mm	30 kg

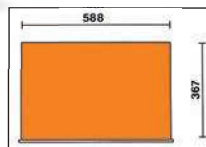

- 5 cassetti laterali di cui:**
- 4 cassetti altezza 70 mm
  - 1 cassetto altezza 210 mm
- 5 cassetti frontali di cui:**
- 4 cassetti altezza 70 mm
  - 1 cassetto altezza 210 mm

RSC51

38 kg

**Carrello di servizio con 3 cassetti**

- 3 cassetti da 588x367 mm, altezza 70 mm
- Piano di lavoro rinforzato in ABS con bordi anticaduta e 8 fori per l'alloggiamento dei giravite
- Possibilità di inserire in ogni cassetto fino a 4 vassoi morbidi in EVA o termoformati rigidi in ABS
- Serratura di sicurezza centralizzata frontale
- Portagiravite laterale e due portabombolette laterali integrate
- Quattro ruote Ø 125 mm: 2 fisse e 2 girevoli (una con freno)

Accessori integrabili disponibili a listino.



400 kg

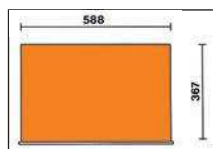

n°	mm	Max
3	70 mm	15 kg

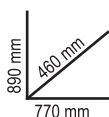

Ral 2011	Ral 3000	Ral 7016
Ral 7016	Ral 7016	Ral 7016
054000008	054000009	054000017

€ 644,00  
**€ 355,00**

C27S

20 kg

**Carrello portautensili richiudibile PER INTERVENTI ESTERNI**

- Modello registrato
- 2 cassetti 588x277 mm montati su guide telescopiche che permettono l'apertura in due sensi
- Ampio vano portaoggetti inferiore 588x277x220 mm
- 2 ruote fisse Ø 160 mm e 2 ruote piroettanti con freno Ø 100 mm
- Piano di lavoro termoplastico con 6 vaschette portaminuterie integrate
- Predisposizione per separatori per cassetto e termoformati MC
- Chiusura centralizzata
- Richiudibile con colonnine ribaltabili per un agevole trasporto



n°	mm	Max
2	70 mm	20 kg



Ral 2011	Ral 3000	Ral 7016
Ral 7016	Ral 7016	Ral 7016
027000004	027000009	027000017

**BREVETTATO**

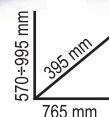

€ 827,00  
**€ 449,00**

**5988VU/M** SOFT MODULE SYSTEM

**30 kg** **059880356**

**Assortimento di 214 utensili**  
in vassoio morbido in EVA

**1/4" 1/2"**  
€ 3.320,00  
**€ 1.850,00**

consigliato con: RSC24 - RSC24A - RSC24AXL - RSC24AXLP/7 - RSC24AXXL - C37 - C39 - C39SM - C39MD - RSC28 - C59 - C58BC - RSC55 - RSC50 2.0

N. pezzi/Descrizione	Beta N.	TR
22 chiavi combinate 6-7-8-9-10-11-12-13-14-15-16-17-18-19-20-21-22-24-27-30-32-36 mm	42	M01
11 chiavi a forchetta 6x7-8x9-10x11-12x13-14x15-16x17-18x19-20x22-21x23-24x27-30x32 mm	55	M30
11 chiavi poligonali curve 6x7-8x9-10x11-12x13-14x15-16x17-18x19-20x22-21x23-24x27-30x32 mm	90	M30
9 chiavi maschio esagonale piegate con estremità sferica ○ 1,5-2,2-5-3-4-5-6-8-10 mm	96BPC/SC9	M30
6 giravite lama piatta ● 2,5x50-3x75-4x100-5,5x125-6,5x150-8x200 mm	1201E	M213
1 giravite per viti a testa con intaglio ● 4x30 mm	1201EN	M213
4 giravite Phillips* ● PH0x60-PH1x80-PH2x100-PH3x150 mm	1202E	M213
1 giravite Phillips* ● PH1x30 mm	1202EN	M213
12 chiavi maschio con impugnatura per viti con impronta Torx® ○ T6-T7-T8-T9-T10-T15-T20-T25-T27-T30-T40-T45	1207E/TX	M213
1 giravite cercafase ●	1253	M213
3 punzoni Ø 2-3-4 mm	30	M230
6 cacciaspina Ø 2-3-4-5-6-8 mm	31	M230
1 bulino Ø 4 mm	32	M230
1 scalpelli piatti 150 mm	34	M230
2 scalpelli piatti nervati 200-250 mm	35	M230
1 ugnetti 125 mm	36	M230
1 martello tipo tedesco 500 g	1370	M230
1 mazzuola con battenti in materiale plastico Ø 35 mm	1390	M230
1 flessometro 3 m	1692	M230
1 magnete telescopico con testa flessibile	1712TF	M230
5x lime 200 mm	1719BMA...Q/T/P/M/R	M230
1 spazzola fili d'acciaio	1737NX	M230
1 cutter con lama a settori 18 mm	1771	M230
1 pinze becchi dritti per anelli elastici, per fori ○ 180 mm	1032	M129
1 pinze becchi piegati per anelli elastici, per fori ○ 170 mm	1034	M129
1 pinze becchi dritti per anelli elastici, per alberi ● 175 mm	1036	M129
1 pinze becchi piegati per anelli elastici, per alberi ● 175 mm	1038	M129
1 pinze regolabili cerniera chiusa 250 mm	1048N	M129
1 pinza autobloccante 240 mm	1052	M129
1 tronchese a taglienti diagonali 160 mm	1082BM	M129
1 tenaglie per cementisti 220 mm	1098	M129
1 cesoia a doppia leva lame dritte 250 mm	1122	M129
1 forbici per elettricisti lame dritte 147 mm	1128BMX	M129
1 pinza universale = 180 mm	1150BM	M129
1 pinza a becchi mezzotondi dritti ● 160 mm	1166BM	M129
1 pinza a becchi mezzotondi piegati ● 160 mm	1168BM	M129
3 bussole portainseri	895/1/3/6	M100MH
13 chiavi a bussola esagonali 1/4" ○ 4-4,5-5-5,5-6-7-8-9-10-11-12-13-14 mm	900	M100MH
9 chiavi a bussola a mano lunghe bocca esagonale ○ 5-6-7-8-9-10-11-12-13 mm	900L	M100MH
5 chiavi a bussola maschio esagonale 1/4" ○ 3-4-5-6-7 mm	900ME	M100MH
4 chiavi a bussola a giravite per viti con intaglio 1/4" ● 0,8x4-1x5,5-1,2x6,5-1,2x8 mm	900LP	M100MH



M01

M30



M213

M230



M129

M100MH

- 4 chiavi a bussola a giravite per viti con impronta a croce Phillips® 1/4" ● PH1-PH2-PH3-PH4
- 7 chiavi a bussola a giravite maschio per viti con impronta Torx® ○ T10-T15-T20-T25-T27-T30-T40
- 1 prolunga - 1/4" 50 mm
- 1 prolunga - 1/4" 100 mm
- 1 prolunga - 1/4" 150 mm
- 1 snodo 1/4"
- 1 quadro con impugnatura 1/4"
- 1 quadro scorrevole 1/4"
- 1 cricchetto reversibile 1/4" ⊕
- 21 chiavi a bussola esagonali 1/2" ○ 8-10-11-12-13-14-15-16-17-18-19-20-21-22-23-24-26-27-28-30-32 mm
- 1 raccordo con attacco quadro 125 mm
- 1 snodo 1/2" 250 mm
- 2 prolunghie angolari - 1/2" 125 mm - 250 mm
- 1 quadro maschio 1/2" con spina scorrevole
- 1 cricchetto reversibile 1/2" ⊕
- 8 chiavi a bussola 1/2" per viti con teste a profilo Torx® ○ 10-12-14-16-18-20-22-24 mm
- 11 chiavi a bussola a mano lunghe bocca esagonale ○ 10-12-13-14-15-16-17-18-19-21-22 mm
- 900PH M100MH
- 900TX M100MH
- 900/20 M100MH
- 900/20L M100MH
- 900/21 M100MH
- 900/25 M100MH
- 900BG/31 M100MH
- 900/42 M100MH
- 900/55 M100MH
- 920A M100MH
- 920/15 M100MH
- 920/25 M100MH
- 920AN/125/250 M100MH
- 920/42 M100MH
- 920/55 M100MH
- 920FTX M100MH
- 920AL M100MH

**5904VU/M** SOFT MODULE SYSTEM

**12 kg** **059041201**

**Assortimento di 90 utensili**  
in vassoio morbido in EVA

**1/2"**  
€ 1.530,00  
**€ 769,00**

consigliato con: RSC23T - RSC24 - RSC24A - RSC24AXL - RSC24AXLP/7 - RSC24AXXL - RSC24L/7 - RSC24L-CAB - RSC28 - C37 - C39 - C39T - C39SM - C39MD - RSC51 - RSC55 - RSC50 2.0 - C59 - C58BC

N. pezzi/Descrizione	Beta N.	TR
16 chiavi combinate 6+21 mm	42	M05
8 chiavi a forchetta 6x7-8x9-10x11-12x13-14x15-16x17-18x19-20x22 mm	55	M33
9 chiavi maschio esagonale piegate ○ 1,5-2,2-3-4-5-6-8-10 mm	96/SC9	M33
6 chiavi maschio con impugnatura per viti con impronta Torx® ○ T8-T10-T15-T20-T25-T30	1227TX	M204MH
3 giravite per viti a testa con intaglio ● 3x75 - 5,5x150 - 6,5x150 mm	1221	M180MH
3 giravite per viti con impronta a croce Phillips® ● PH0x60-PH1x80-PH2x100 mm	1222	M180MH
8 chiavi maschio esagonale con impugnatura ○ 2-2,5-3-4-5-6-7-8 mm	96T	M50
1 prolunga angolare - 1/2" 125 mm	920AN/125	M83
1 prolunga angolare - 1/2" 250 mm	920AN/250	M83
1 snodo 1/2"	920/25	M83
1 quadro maschio 1/2" con spina scorrevole	920/42	M83
1 cricchetto reversibile 1/2" ⊕	920/55	M83
19 chiavi a bussola esagonali 1/2" ○ 10+24 - 26 - 27 - 30 - 32 mm	920A	M83
1 tronchese a grande effetto taglienti diagonali 160 mm	1084	M137
1 pinza universale = 180 mm	1150	M137
1 pinza a becchi mezzotondi dritti ● 160 mm	1166	M137
1 pinze regolabili cerniera chiusa 250 mm	1048N	M153
1 pinza autobloccante 240 mm	1052	M153
2 scalpelli piatti nervati 100 - 200 mm	35	M234
1 martello tipo tedesco 300 g	1370	M234
1 mazzuola con battenti in materiale plastico Ø 35 mm	1390	M234
1 pinze becchi dritti per anelli elastici, per fori ○ 180 mm	1032	M145
1 pinze becchi piegati per anelli elastici, per fori ○ 170 mm	1034	M145
1 pinze becchi dritti per anelli elastici, per alberi ● 175 mm	1036	M145



M05 M33 M204MH M180MH

M50 M83



M137 M153 M234 M145

SCOPRI DI PIÙ



**CONFIGURATORE ONLINE**

Componi la tua cassettera con gli assortimenti di utensili

**M01**

4,5 kg 024500001



22

€ 466,00  
€ 269,00

- 42 6-7-8-9-10-11-12-13-14-15-16-17-18  
19-20-21-22-24-27-30-32-36 mm

**M25**

5,1 kg 024500025



40

€ 749,00  
€ 410,00

- 42 6-7-8-9-10-11-12-13-14-15-16-17-18-19-21-22-24-27 mm
- 90 6x7-8x9-10x11-12x13-14x15-16x17-18x19 mm
- 123Q1/4
- 123Q3/8
- 123Q1/2
- 142 8-9-10-11-12-13-14-15-16-17-18-19 mm

**M60MH**

1,9 kg 024500072



23

€ 459,00  
€ 215,00

- 96T 2-2,5-3-4-5-6-7-8-10 mm
- 97BTX/SC8 T9-T10-T15-T20-T25-T27-T30-T40 mm
- 944MH 5-6-7-8-10-13 mm

**NEW**

**M63**

3,4 kg 024500063



8

€ 361,00  
€ 212,00

- 952 7-8-10-12-13-14-17-19 mm

**M100MH**

6,7 kg 024500109

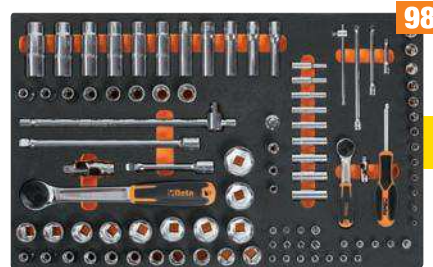

98

€ 1.265,00  
€ 599,00



14" 12"

- 895/1 - 895/3 - 895/6
- 900 4-4,5-5-5,5-6-7-8-9-10-11-12-13-14 mm
- 900L 5-6-7-8-9-10-11-12-13 mm
- 900ME 3-4-5-6-7 mm
- 900LP 0,8x4-1x5,5-1,2x6,5-1,2x8 mm
- ⊕ 900PH PH1-PH2-PH3-PH4
- 900TX T10-T15-T20-T25-T27-T30-T40
- 900/20 50 mm - 900/20L 100 mm
- 900/21 150 mm
- 900/25
- 900BG/31
- 900/42
- ⊗ 900/55
- 920A 8-10-11-12-13-14-15-16-17-18-19-20-21-22-23-24-26-27-28-30-32 mm
- 920/15 - 920/25
- 920AN/125 125 mm
- 920AN/250 250 mm
- 920/42
- ⊗ 920/55
- 920FTX 10-12-14-16-18-20-22-24 mm
- 920AL 10-12-13-14-15-16-17-18-19-21-22 mm

**NEW**

**M105MH**

7,7 kg 024500114



116

€ 1.375,00  
€ 649,00



14" 3/8" 12"

- 900 4-4,5-5-5,5-6-7-8-9-10-11-12-13-14 mm
- 900L 5-6-7-8-9-10-11-12-13 mm
- 96BPC/SC9 1,5-2-2,5-3-4-5-6-8-10 mm
- 895/1 - 895/3 - 895/6
- 900ME 3-4-5-6-7 mm
- 900LP 0,8x4-1x5,5-1,2x6,5-1,2x8 mm
- ⊕ 900PH PH1-PH2-PH3-PH4
- 900TX T10-T15-T20-T25-T27-T30-T40
- 900/16 □ 1/4 - ■ 3/8
- 900/... 50-100-150 mm
- 900/25 - 900BG/31 - 900/42
- ⊗ 900/55
- 910A 6-7-8-9-10-11-12-13-14-15-16-17-18-19-20-21-22 mm
- 910/15 □ 3/8 - ■ 1/4
- 3/8 - ■ 1/2
- 910/21 125 mm
- 910/22 250 mm
- 910/25 - 910/42
- ⊗ 910/55
- 920A 8-10-11-12-13-14-15-16-17-18-19-20-21-22-23-24-26-27-28-30-32 mm
- 1/2 - ■ 3/8
- 920/15
- 920/25
- 920AN 125 - 250 mm
- 920/42
- ⊗ 920/55
- 956E 16-17,8-20,8 mm

**NEW**

**M120**

6,9 kg 024500120



75

€ 1.350,00  
€ 649,00

12"

- 920A 10-11-12-13-14-15-16-17-18-19-20-21-22-24-26-27-30-32 mm
- 920AN/125 125 mm
- 920AN/250 250 mm
- 920/25 - 920/42
- 920AL 10-12-13-14-15-16-17-18-19-22-24-27-30-32 mm
- 920FTX 10-12-14-16-18-20-22-24 mm
- ⊗ 920/55
- 920PE 5-5L-6-6L-7-7L-8-8L-10-10L-12-12L-14-14L
- 920TY T20-T25-T27-T30-T40-T45-T50-T55-T60

M125

7,9 kg 024500872



68

€ 1.320,00  
€ 599,00

38" 12"

- 910AL 8-9-10-11-12-13-14-15-16-17-19-21-22 mm
- 920FTX E12-E14-E16-E18-E20-E22-E24
- 920PE 5-6-6L-7-8-8L-10-10L-12-12L mm
- 920TX T20-T25-T27-T30-T30L-T40-T40L-T45-T50-T50L-T55-T60-T60L
- 920XZN 5-6-6L-8-8L-10-10L-12L mm
- 920AL 10-12-13-14-15-16-17-18-19-21-22-23-24-27-30-32 mm
- 1692/5 5 m

M195MH

3,4 kg 024500196

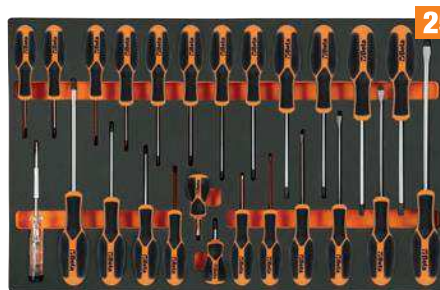

25

€ 384,00  
€ 209,00



- 1253 3,5x100 mm
- 1221 2,5x50 - 3x75 - 4x100 - 5,5x125 - 6,5x150 - 8x200 mm
- 1222 PH0x60 - PH1x80 - PH2x100 - PH3x150 mm
- 1222N PH1X30 mm
- 1227TX T6-T7-T8-T9-T10-T15-T20-T25-T27-T30-T40-T45
- 1221N 4x30 mm

**NEW**

M129

3,4 kg 024500147



13

€ 490,00  
€ 275,00

- |               |                |                 |
|---------------|----------------|-----------------|
| ● 1032 180 mm | 1052 240 mm    | 1150BM 180 mm   |
| ● 1034 170 mm | 1082BM 160 mm  | ● 1166BM 160 mm |
| ● 1036 175 mm | 1098 220 mm    | ● 1168BM 160 mm |
| ● 1038 175 mm | 1122 250 mm    |                 |
| 1048N 250 mm  | 1128BMX 147 mm |                 |

**NEW**

M213

1,8 kg 024500213



25

€ 229,50  
€ 133,00



- 1201E 2,5x50-3x75-4x100-5,5x125-6,5x150-8x200 mm
- 1201EN 4x30 mm
- 1202E PH0x60-PH1x80-PH2x100-PH3x150 mm
- 1202EN PH1X30 mm
- 1207E/TX T6-T7-T8-T9-T10-T15-T20-T25-T27-T30-T40-T45
- 1253 3,5x100 mm

M166MH

2,9 kg 024500881



49

€ 465,00  
€ 239,00



- ○ ⊕ ⊕ ⊕ 861MIX/A31
- 1048N 250 mm
- 1082BM 160 mm
- 1150BM 180 mm
- 1162BM 160 mm
- 1221 3x75 - 4x100 - 5,5x100 - 6,5x150 - 8x150 mm
- 1221N 6,5x30 mm
- 1222 4,5x80 - 6x100 - 8x150 mm
- 1222N 6x30 mm
- 1227TX T20-T25-T27-T30

**NEW**

M230

3,2 kg 024500230



25

€ 438,00  
€ 252,00

- |                    |                     |               |
|--------------------|---------------------|---------------|
| ■ 1719BMA/Q 200 mm | 1737NX              | 35 200-250 mm |
| ▲ 1719BMA/T 200 mm | 1771 170 mm         | 36 125 mm     |
| ● 1719BMA/P 200 mm | 30 Ø 2-3-4 mm       | 1370 500 g    |
| ● 1719BMA/M 200 mm | 31 Ø 2-3-4-5-6-8 mm | 1390 Ø 35 mm  |
| ● 1719BMA/R 200 mm | 32 Ø 4 mm 34 150 mm | 1692 3 m      |
|                    |                     | 1712TF        |



M320

5 kg 024500320



146

€ 941,00  
€ 469,00

TRAPANO AVVITATORE 20V 1972/K20V-13BMC



ADATTO A CASSETTI DA 140 mm

- 410MIX/SEL19
- 861/C100
- 862XP/A16

**T01** 024240001  
 2,7 kg  
 € 284,00  
**€ 165,00**



42 6-7-8-10-11-12-13-14-16-17-18-19-21-22-24-27-30 mm

**T05** 024240005  
 1,5 kg  
 € 215,50  
**€ 126,00**



42 6-7-8-10-11-12-13-14-16-17-18-19-21-22-24-27-30 mm

**T06** 024240006  
 2,1 kg  
 € 154,00  
**€ 90,00**



42 22-24-27-30-32 mm

**T31** 024240031  
 3 kg  
 € 232,00  
**€ 135,00**



31 Ø 2-3-4-5-6 mm 32 Ø 4 mm  
 55 6x7-8x9-10x11-12x13-14x15-16x17-18x19  
 20x22-21x23-24x26-27x29-30x32 mm  
 ○ 96N/SC9 1,5+10 mm

**T45** 024240045  
 1,3 kg  
 € 326,00  
**€ 190,00**

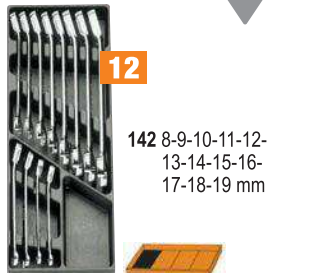

142 8-9-10-11-12-13-14-15-16-17-18-19 mm

**T50** 024240050  
 1,3 kg  
 € 184,50  
**€ 107,00**



○ 96T 2-2,5-3-3,5-4-4,5-5-6-7-8-10 mm

**T63** 024240063  
 3,8 kg  
 € 351,00  
**€ 204,00**



○ 952 7-8-10-12-13-14-17-19 mm

**T68** 024240068  
 590 g  
 € 151,00  
**€ 86,00**



○ 951 2,5-3-4-5-6-8 mm

**T80** 024240080  
 4,1 kg  
 € 433,00  
**€ 205,00**



○ 920A 10-11-12-13-14-15-16-17-18-19  
 20-21-22-23-24-26-27-30-32 mm  
 ○ 920ME 5-6-8-10-12 mm  
 920/21 125 mm 920/22 255 mm  
 920/25 - 920/42 305 mm ◎ 920/55

**T91MH** 024240098  
 560 g  
 € 243,00  
**€ 105,00**



○ 900 4-4,5-5-5,5-6-7-8-9-10-11-12-13-14 mm  
 ○ 900ME 2,5-3-4-5-6-8 mm  
 900/20 50 mm 900/21 150 mm  
 900/25 - 900BG/31 - 900/42 115 mm ◎ 900/55

**T92** 024240092  
 1,5 kg  
 € 266,00  
**€ 112,00**



○ 910A 6-7-8-9-10-11-12-13-14-15-16-17-18-19-20-21-22 mm  
 910/21 125 mm 910/42 210 mm  
 910/22 250 mm ◎ 910/55  
 910/25

**T137** 024240137  
 750 g  
 € 128,00  
**€ 70,00**



↗ 1084BM 160 mm  
 ≡ 1150BM 180 mm  
 ● 1166BM 160 mm

**T145** 024240145  
 640 g  
 € 135,50  
**€ 79,00**

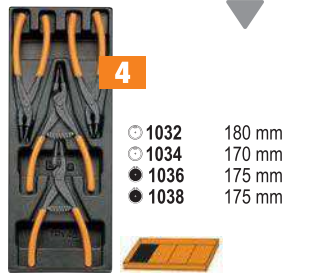

○ 1032 180 mm  
 ○ 1034 170 mm  
 ● 1036 175 mm  
 ● 1038 175 mm

**T167MH** 024240182  
 1,3 kg  
 € 157,00  
**€ 92,00**



● 1221 3x75-3x100-4x100-4x150-5,5x100-5,5x150-6,5x150-8x150-10x200 mm  
 ● 1221N 4x20 - 6,5x20 mm

**T234** 024240234  
 1,3 kg  
 € 104,50  
**€ 61,00**



35 100-200 mm  
 1370 300 g  
 1390 ø 35 mm

**T236** 024240236  
 870 g  
 € 103,00  
**€ 60,00**



■ 1719BMA/Q 200 mm  
 ▲ 1719BMA/T 200 mm  
 ▨ 1719BMA/P 200 mm  
 ▩ 1719BMA/M 200 mm  
 ● 1719BMA/R 200 mm

**NEW**

# MODULAR *line*

## BANCHI componibili

SCOPRI DI PIÙ



### C58BC-W2,1 4CA+SVR LED

169,5 kg

Banco da lavoro 2,1 m con piano in legno, 4 cassetti e modulo anta

Caratteristiche principali:

- Piano di lavoro in legno multistrato 2.100x750 mm, spessore 38 mm
- 4 cassetti da 367x588 mm, montati su guide telescopiche a sfera:
  - 2 cassetti altezza 70 mm
  - 2 cassetti altezza 140 mm.
- Piano dei cassetti protetto da tappetini di gomma espansa
- Possibilità di inserire in ogni cassetto fino a 4 vassoi morbidi in EVA o termoformati rigidi in ABS
- Serratura centralizzata frontale
- 1 modulo con anta dotato di serratura
- Struttura in acciaio con 4 gambe di sostegno
- Fori per la collocazione di una morsa 1599F/150 - 1599GI/150 (da ordinare separatamente)
- 2 semi ripiani inferiori portaoggetti 1.788x335 mm, spessore 40 mm
- Predisposizione per il fissaggio al pavimento
- Kit 4 pannelli forati
- 2 binari con lampade led IP20



kg  
800

1860 mm  
750 mm  
2100 mm



Ral 2011	Ral 7016
Ral 7016	058000748
058000743	058000748

€ 2.330,00  
€ 1.299,00

**NEW**

### C58BC-2,1

Banco da lavoro semplice da 2,1 m

- Semi ripiano inferiore portaoggetti 1.788x335 mm, spessore 40 mm
- Struttura in acciaio con 4 gambe di sostegno
- Fori per la collocazione di una morsa 1599F/150 - 1599GI/150 (da ordinare separatamente)
- Predisposizione per il fissaggio al pavimento



kg  
800

903 mm  
750 mm  
2100 mm

### C58BC-W2,1

70 kg 058000621



€ 717,00  
€ 395,00

- Piano di lavoro in legno multistrato 2.100x750 mm, spessore 38 mm

### C58BC-X2,1

93 kg 058000626



€ 748,00  
€ 395,00

- Piano di lavoro in MDF rivestito in acciaio inossidabile 2.100x750 mm, spessore 38 mm

### 8888/KPS

088880813

Kit piastrelle antiscivolo in PVC

Composto da:

- 10 piastrelle componibili antiscivolo in PVC, 500x500x80 mm (art. PCP)
- 10 scivoli gialli ad incastro maschio (art. SCG/M)
- 10 scivoli gialli ad incastro femmina (art. SCG/F)

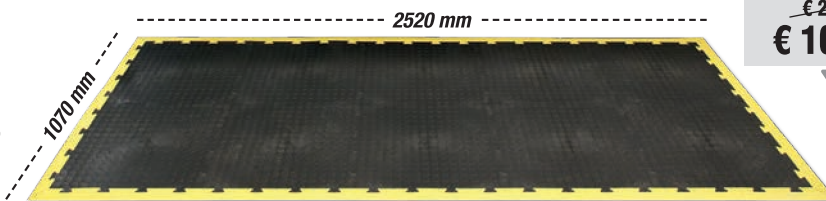

€ 279,00  
€ 160,00

**NEW**

**C56BLP**

11,4 kg

05600005

**Banco da lavoro pieghevole multiuso**

- Piano di lavoro da 820x630 mm in polipropilene con scala graduata in millimetri e pollici
- Ripiano inferiore portaoggetti
- Gambe telescopiche in alluminio (550÷820 mm)
- Possibilità di utilizzo come cavalletto
- Piedini anti-scivolo
- Maniglia per un agevole trasporto

~~€ 345,00~~  
**€ 175,00**



**SOLO 11,4 kg!**

**ACCESSORI DI FISSAGGIO INCLUSI**

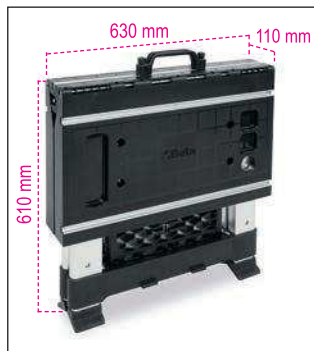

**PRONTO ALL'USO IN POCHI SECONDI,  
FACILE DA TRASPORTARE  
E DA RIPORRE IN SPAZI RIDOTTI.**

SCOPRI DI PIÙ



**C56PL O**

18,5 kg

056000021

**Banco da lavoro pieghevole**

- Leggero, compatto e facilmente trasportabile
- Piano di lavoro 800x500mm in lamiera zincata utilizzabile da un solo lato, protetto con rivestimento in gomma antiolio e antibenzina
- Maniglia con protezione in gomma per un agevole trasporto
- Piedini con copertura anti-scivolamento

~~€ 388,00~~  
**€ 219,00**



**SOLO 18,5 kg**

**C51**

21 kg

**Carrello**

- 3 ripiani ricoperti in gomma millerighe antiscivolo
- Doppia possibilità di fissaggio del ripiano centrale
- Quattro ruote Ø 100 mm: 2 fisse e 2 girevoli (una con freno)



Ral 2011 Ral 7016 Ral 3000  
051000001 051000002 051000003

~~€ 322,00~~  
**€ 179,00**

C48M



140 kg 048000230

€ 3.080,00  
€ 1.699,00

Carrello contenitore elettrico, con sponde

- Pianale motorizzato con motore 24V - 400 W con alimentazione a batteria 2x12V 33 Ah e scheda di controllo Curtis.
- Piano di carico realizzato in solido acciaio, ricoperto con gomma antiscivolo, con sponde tubolari di contenimento a sezione tonda per il trasporto del carico in sicurezza.
- Le sponde possono anche essere sfilate, per adattarsi alle singole esigenze di trasporto.
- Dotato di 2 ruote pneumatiche di trazione Ø 260 mm e 2 ruote in gomma piroettanti Ø 150 mm, freno elettromagnetico e differenziale.
- Carica batterie esterno 220V/50Hz - V/A 24/12 in dotazione.

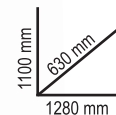

CARATTERISTICHE FUNZIONALI

- Capacità di carico: **400 kg**
- Velocità di marcia: **4-6 km/h** (regolabile)
- Autonomia: **4 ore**
- Pendenza massima superabile a pieno carico: **6%**
- Pendenza massima superabile con 100 kg di carico: **18%**

CARATTERISTICHE TECNICHE

- Dimensioni di ingombro: 1280x630x1100 mm
- Dimensioni utili piano di carico con sponde: 1180x580 mm
- Dimensioni utili piano di carico senza sponde: 1260x620 mm
- Altezza pianale di carico dal pavimento: 320 mm
- Altezza vano batteria-pavimento: 65 mm
- Peso con batterie: 140 kg

DISPOSITIVI DI SICUREZZA:

- Freno elettronico
- Segnalatore acustico
- Protezione antischiacciamento
- Indicatore dello stato di carica della batteria
- Scheda di controllo Curtis

C48P

11 kg 048000030

€ 289,00  
€ 164,00

Carrello pieghevole

- Pianale di carico in polipropilene (PP) rinforzato, con rivestimento antiscivolo e inserti in TPV per la protezione degli spigoli
- Maniglia richiudibile per uno stoccaggio rapido e poco ingombrante
- Quattro ruote antitraccia Ø 125 mm: 2 fisse e 2 girevoli con freno
- Portata massima 300 kg.
- Larghezza utile pianale di carico: 705 mm
- Profondità pianale di carico: 480 mm
- Altezza pianale di carico: 200 mm



3069

69,5 kg 030690000

€ 814,00  
€ 359,00

Transpallet manuale

Caratteristiche:

- 2 ruote direzionali 200x50 mm in PU
- Rulli doppi anteriori 80x70 mm in PU
- Rulli guida per l'accesso al pallet
- Tacca indicazione battuta di profondità
- Valvola di controllo velocità di discesa
- Valvola di sicurezza in caso di sovraccarico
- Timone in metallo rivestito per un comfort superiore
- **Leva di azionamento a 3 posizioni (salita, discesa, folle)**

Dati tecnici:

- Capacità massima: 2500 kg
- Lunghezza totale: 1550 mm
- Lunghezza forche: 1150 mm
- Larghezza forche: 540 mm
- Larghezza singola forca: 160 mm
- Altezza leva: 1230 mm
- Altezza max. sollevamento: 200 mm
- Corridoio di stivaggio per pallet 800x1200 longitudinalmente: 1805 mm
- Raggio di volta: 1347 mm



**C41H**

**21 kg**

**Trolley portautensili a 2 moduli sovrapponibili**

- Struttura in lamiera e in materiale plastico: grande robustezza e peso ridotto
- 2 moduli separabili: 1 cestello superiore, 1 modulo con 2 cassetti altezza 95 mm, 1 cassetta estraibile in materiale plastico altezza 66 mm e 1 cassetto altezza 295 mm
- Ruote di grosso diametro 160 mm integrate nella struttura per facilitare il trasporto anche su gradini
- Serratura centralizzata laterale per la chiusura dei cassetti del modulo inferiore
- Cassetti montati su guide telescopiche a sfera con doppio gancio di chiusura
- Impugnatura con manico telescopico in alluminio
- Portaminuterie integrato
- Cassetto inferiore con doppia guida telescopica



C41H O  
RAL 2011



~~€ 641,00~~  
**€ 349,00**

- 041000002
- 041000021
- 041000012
- 041000008
- 041000006
- 041000010
- 041000005



C41H W  
RAL 9016

C41H Y  
RAL 1023

C41H R  
RAL 3000

C41H B  
RAL 5002

C41H G  
RAL 7016

C41H N  
RAL 9005

**Cestello estendibile a 5 scomparti in lamiera, vuoto**

**C20**

**4,3 kg**    021200001

450x200x210 mm

~~€ 87,00~~  
**€ 48,00**

**C20L**

**5,7 kg**    021200002

550x200x210 mm

~~€ 95,50~~  
**€ 54,00**



**CP15L**

**2,9 kg**    021150202

**Cestello modello lungo in materiale plastico con contenitore e vaschette portaminuterie**

~~€ 72,00~~  
**€ 41,00**

- 3 vaschette portaminuterie integrate nel coperchio con divisori regolabili
- 1 contenitore interno con divisori regolabili

558x277x270 mm



**CP17**

**2,1 kg**    021170500

**Cestello in acciaio inox e materiale plastico con contenitore asportabile**

~~€ 99,00~~  
**€ 56,00**

500x200x220 mm



**Baule portautensili in lamiera, vuoto**



**C22B-O**

**13 kg**    022000150

720x320x310 mm

~~€ 247,00~~  
**€ 141,00**

**C22BM-O**

**20 kg**    022000160

850x360x350 mm

~~€ 284,00~~  
**€ 164,00**

**C22BL-O**

**26 kg**    022000170

1010x410x400 mm

~~€ 379,00~~  
**€ 219,00**

**Valigia organizer 15 scomparti**

Indispensabili per contenere e trasportare minuteria in maniera ordinata e sicura. Separatori amovibili e robusto coperchio trasparente per una rapida individuazione del contenuto.



**Impilabili**



**2080/DS**

760 g 020800210

**SMALL con 10 divisori estraibili**

375x315x65 mm

~~€ 22,70~~  
**€ 13,40**

**2080/DL**

970 g 020800211

**LARGE con 8 divisori estraibili**

440x330x75 mm

~~€ 27,00~~  
**€ 15,50**

**2028/VV**

4,7 kg 020280010

**Valigia portautensili in polipropilene, vuota**

- 2 pannelli portautensili
- Fondo interno con divisori removibili
- Doppia chiusura con combinazione

~~€ 254,00~~  
**€ 141,00**



480x190x400 mm



**2080/V12**

1,8 kg 020800000

**Valigia organizer con 12 vaschette asportabili**

~~€ 65,50~~  
**€ 37,00**

Vaschette portaminuteria asportabili, richiudibili e trasparenti per un'immediata riconoscibilità del contenuto.



300x330x145 mm



**2031/TV**

5,2 kg 020310200

**Trolley portautensili in polipropilene ad alto spessore, profilato in alluminio, vuoto**

~~€ 419,00~~  
**€ 243,00**

- 3 pannelli portautensili
- Manico telescopico
- Ruote con cuscinetti a sfera
- Fondo interno con divisori removibili



475x235x385 mm



**NEW**

**C5**

2,8 kg 021050000

**Zaino portautensili in tessuto tecnico, vuoto**

- Pannello portautensili interno removibile
- 6 tasche esterne e 2 tasche interne
- Base in materiale plastico resistente all'acqua
- Doppio laccetto di sicurezza per fissare lo zaino sulle spalle
- Schienale ergonomico imbottito

~~€ 169,00~~  
**€ 97,00**



**C6T**

4,9 kg 021060010

**Zaino portautensili con ruote, vuoto**

- Manico telescopico di trasporto
- Ruote integrate nella struttura con copertura anti-polvere per l'impiego come zaino
- 2 pannelli portautensili removibili
- Tasca per PC interna e 5 tasche esterne
- Base in materiale plastico resistente all'acqua

~~€ 240,00~~  
**€ 139,00**



**CSM**

**Zaino portautensili in tessuto tecnico, vuoto**

- Ampio vano frontale con chiusura a zip, dotato di:
  - 4 file esterne di elastici per un rapido accesso agli utensili
  - 6 tasche portautensili interne per un'organizzazione tecnica efficiente
- Due pratiche tasche laterali con chiusura a zip, porta badge ed elastici portautensili



≡ 370x210x510 mm

📦 1,9 kg

📄 021050050

~~€ 96,50~~  
**€ 55,00**

**All'interno dello zaino:**

- 3 file di elastici portautensili
  - 10 tasche portautensili di diverse dimensioni
- Maniglia centrale imbottita sulla sommità dello zaino per una presa stabile ed equilibrata
  - Spallacci imbottiti regolabili
- Schienale ergonomico imbottito
  - Base rinforzata in materiale plastico resistente all'acqua



**NEW**

**CBA**

**Trolley portautensili in tessuto tecnico, vuoto**

- Struttura semirigida
- Manico telescopico per un agevole trasporto
- 4 ruote piroettanti
- Doppia maniglia imbottita per una presa bilanciata e sicura
- Pratico vano frontale semirigido per contenere oggetti personali
- Ampio scompartimento inferiore con 5 tasche ed elastici portautensili
- 33 tasche interne portautensili
- 6 file interne di elastici portautensili
- 6 file laterali di elastici portautensili con robusto gancio in metallo per flessometro
- Tasca interna in materiale plastico con chiusura a zip



≡ 455x270x480 mm

📦 5,9 kg

📄 021080400

~~€ 189,00~~  
**€ 109,00**



**NEW**

**C8**

**Trolley portautensili in tessuto tecnico, vuoto**

- Manico telescopico di trasporto
- 2 pannelli interni portautensili removibili
- Tasca porta PC interna
- 2 tasche esterne frontali
- Predisposizione per l'alloggiamento del cestello C10S

📦 5,5 kg

📄 021080000

~~€ 282,00~~  
**€ 153,00**

**Cestello portautensili in tessuto tecnico, vuoto**

- Struttura rigida
- Doppio fondo
- Manico inclinabile per facilitare l'accesso agli utensili
- Elastici portautensili e tasche sia interne che esterne
- Vaschetta portaminuterie inclusa nel doppio fondo
- Fodero di copertura
- Predisposizione per essere utilizzata con il trolley C8



**C10S**

📦 2,9 kg

📄 021100001

~~€ 135,00~~  
**€ 78,00**

≡ 420x220x250 mm

**C10**

📦 3,3 kg

📄 021100000

~~€ 171,50~~  
**€ 99,00**



**C11**

**1,8 kg** 021110000

**Cestello portautensili, vuoto**

- Base rigida in materiale plastico, resistente all'acqua
- Elastici e tasche portautensili sia interne che esterne
- Buste portadocumenti integrate nel doppio fondo del coperchio

~~€ 100,00~~  
**€ 59,00**

410x230x250 mm



**C7**

**4 kg** 021070000

**Borsa portautensili in tessuto tecnico, vuota**

- 2 pannelli interni portautensili removibili
- 2 tasche esterne frontali
- Fondo interno in materiale plastico con divisori removibili

~~€ 250,00~~  
**€ 133,00**



480x165x380 mm



**C3**

**917 g** 021030000

**Mini borsa portautensili in tessuto tecnico, vuota**

- 1 tasca esterna frontale con chiusura a zip
- 2 tasche laterali con vaschette portaminuteria incluse
- 1 pratica tasca posteriore con chiusura a velcro
- 1 pannello portautensili interno removibile, con elastici presenti su ambo i lati
- Fornita completa di tracolla
- Interfaccia USB per la ricarica dei propri dispositivi mobili

~~€ 70,00~~  
**€ 40,00**



230x110x320 mm

**UNA MINI BORSA PORTAUTENSILI DA PORTARE SEMPRE CON TE!**

**2005MMT**

**500 g** 020050070

**Marsupio porta attrezzi con cintura, vuoto**

- Ampio scompartimento frontale con all'interno una pratica busta avvolgibile con tasche ed elastici portautensili
- Due ampie tasche portaoggetti, di cui una con chiusura a velcro
- Tasca interna frontale con chiusura a zip
- Doppia chiusura del marsupio, con velcro e con fibbia
- Cintura traspirante con fascia elasticizzata e due tasche portaoggetti

~~€ 51,00~~  
**€ 29,80**



250x160x100 mm



**NEW**

**2001/BZ27 VU**

**Valigetta pieghevole con assortimento di 27 utensili per interventi universali**

**3,9 kg** 020010157

~~€ 302,00~~  
**€ 174,00**



**27**

N. pezzi/Descrizione	Beta N.
1 forbici per elettricisti lame diritte 147 mm	1128BMX
1 pinza universale 180 mm	1150
6 chiavi combinate 7-8-10-13-17-19 mm	42
3 giravite lama piatta	1201E
• 3x75 - 4x100 - 5,5x150 mm	
3 giravite Phillips®	1202E
• PH0x60 - PH1x80 - PH2x100 mm	
9 chiavi maschio esagonale piegate	96/SC9
• 1,5-2-2,5-3-4-5-6-8-10 mm	
1 martello tipo tedesco 300 g	1370
1 pinze regolabili cerniera chiusa 250 mm	1048N
1 flessometro 5 m	1692/5

42

## L'ICONICA CHIAVE BETA

Una forma elegante e snella, alleggerita nelle linee e più leggera al tatto

La forza, la resistenza e l'ergonomia della chiave Beta raggiungono valori ancora superiori per offrire la miglior chiave possibile alle mani degli utilizzatori. Il processo produttivo si svolge nei nostri stabilimenti di Sovico e Sulmona, avvalendosi delle tecnologie più avanzate in termini di automazione e degli operatori più preparati in termini di esperienza.

SCOPRI DI PIÙ



### FORZA

Valori di coppia più che doppi rispetto ai requisiti della norma ISO 1711.

### RESISTENZA

Grande resistenza: nel caso di uso improprio la chiave inizia a deformarsi, non si spezza in modo improvviso e pericoloso.

### ERGONOMIA

L'occhio poligonale è inclinato di 15° per proteggere la mano. La forma è ottenuta da stampo, non piegata successivamente.



### 42/SP15

Serie di 15 chiavi combinate

- Comodo e pratico supporto incluso



6-7-8-9-10-11-12-13-14-15-16-17-19-22-24 mm

000421078

€ 195,50  
€ 112,00

### 42/S26

Serie di 26 chiavi combinate



6-7-8-9-10-11-12-13-14-15-16-17-18-19-20-21-22-23-24-25-26-27-28-29-30-32 mm

000421070

€ 469,00  
€ 267,00

### 55/B12N

Serie di 12 chiavi a forchetta doppie in busta avvolgibile di poliestere resistente

6x7-8x9-10x11-12x13-14x15-16x17-18x19-20x22-21x23-24x26-25x28-30x32 mm



000550164

€ 157,50  
€ 92,00

### 141/B9

Serie di 9 chiavi combinate a cricchetto diritte, in busta di tela

8-10-11-12-13-14-15-17-19 mm



001410069

€ 201,00  
€ 92,00





# NUOVI SUPPORTI PIÙ COMPATTI

## 42/SC8

Serie di 8 chiavi combinate  
con supporto compatto

000421086

~~€ 188,50~~  
**€ 63,00**



8-10-12-13-14-15-17-19 mm

**NEW**

## 142SN/SC8

Serie di 8 chiavi combinate  
a cricchetto snodate  
con supporto compatto

001420258

~~€ 252,00~~  
**€ 145,00**



8-10-12-13-14-15-17-19 mm

**NEW**

## 142/SC8

Serie di 8 chiavi combinate  
a cricchetto reversibile  
con supporto compatto

001420086

~~€ 211,50~~  
**€ 119,00**



8-10-12-13-14-15-17-19 mm

**NEW**

## 192/52

Serie di 2 chiavi poligonali  
a cricchetto reversibile

001920070

~~€ 69,00~~  
**€ 40,00**



### 8 MISURE IN 2 CHIAVI



## 186 8-32

Chiave autoserrante a ripresa  
automatica per esagoni da 8 a 32 mm

001860008

~~€ 52,00~~  
**€ 30,00**

Ideale per viti con testa a profilo:  
esagonale, Spline®, quadrato, Torx®; anche rovinate.



L 260 mm



# CHIAVI REGOLABILI A RULLINO

# 111

Le chiavi a rullino Beta 111 consentono di avvitare e svitare dadi e bulloni di diverse dimensioni grazie alla ganascia mobile, regolabile tramite il rullino posto al centro.



- Realizzata in acciaio legato ad alte prestazioni per **un'elevata resistenza meccanica alle torsioni e all'usura.**
- Lo studio della nuova ergonomia ha permesso di avere una **riduzione di peso del 20%.**

**1** Testa inclinata di 15° per manovrare anche negli spazi più difficili come le nostre iconiche chiavi combinate "42"

**2** Doppia marcatura laser in mm/pollici

**3** Ingombro ridotto della testa ganascia completamente aperta

**4** Foro su impugnatura per appendere la chiave

SCOPRI DI PIÙ



## 111CM 220

Chiavi regolabili a rullino corte con **APERTURA MAGGIORATA**, rotazione destrorsa del rullino cromate



001110722

€ 49,50  
**€ 28,90**



L mm	L "	A max mm
220	8 1/2	29

## 111E

Chiavi regolabili a rullino con scala graduata, rotazione destrorsa del rullino **CROMATE**



	L mm	L "	A max mm		€
<b>111E 150</b>	150	6	24	001110115	<del>€ 28,00</del> <b>€ 16,00</b>
<b>111E 200</b>	200	8	29	001110120	<del>€ 34,00</del> <b>€ 19,70</b>
<b>111E 250</b>	250	10	34	001110125	<del>€ 41,00</del> <b>€ 24,00</b>
<b>111E 300</b>	300	12	40	001110130	<del>€ 54,50</del> <b>€ 31,70</b>

## PROMO 111E/D3

Serie di 3 chiavi a rullino cromate con scala graduata



001110163

€ 103,00  
**€ 54,90**



**RISPARMI € 4,80**  
Rispetto all'acquisto dei prodotti sciolti



## 111ER

Chiavi regolabili a rullino cromate con scala graduata

- Ganascia reversibile
- Scala in millimetri e in pollici



### ROTAZIONE DESTORSORA DEL RULLINO

	L mm	L "	A max mm		€
<b>111ER 200</b>	200	8	29	001110520	<del>€ 35,50</del> <b>€ 19,90</b>
<b>111ER 250</b>	250	10	34	001110525	<del>€ 44,00</del> <b>€ 24,00</b>
<b>111ER 300</b>	300	12	40	001110530	<del>€ 57,00</del> <b>€ 31,90</b>

### 96/SC9

Serie di 9 chiavi maschio esagonale piegate



000960374

€ 22,40  
€ 12,30



**COMPATTE**

Ø mm	L mm
1,5	45
2	50
2,5	57
3	64
4	72
5	83
6	94
8	105
10	119

### 96BPC/SC9

Serie di 9 chiavi maschio esagonale piegate con un'estremità sferica



000960354

€ 46,50  
€ 23,50

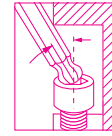

Ø mm	L mm
1,5	79
2	84
2,5	89
3	99
4	108
5	126
6	148
8	168
10	187

### 97BTX/SC8

Serie di 8 chiavi maschio piegate con un'estremità sferica per viti con impronta Torx®



000970164

€ 81,50  
€ 45,00

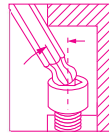

Ø mm	L mm
T9	62
T10	71
T15	81
T20	92
T25	94
T27	105
T30	114
T40	129

### 97BTXL/SC8

Serie di 8 chiavi maschio piegate con un'estremità sferica, modello lungo per viti con impronta Torx®



000970364

€ 94,00  
€ 50,50

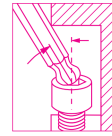

Ø mm	L mm
T9	80
T10	86
T15	100
T20	110
T25	126
T27	140
T30	160
T40	176

**MODELLO EXTRA LUNGO +25%**

### 97BRTLXL/SC8

Serie di 8 chiavi maschio piegate con un'estremità sferica, modello lungo per viti con impronta Tamper Resistant Torx®



000970464

€ 98,00  
€ 46,00

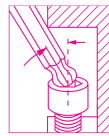

Ø mm	L mm
T9	80
T10	86
T15	100
T20	110
T25	126
T27	140
T30	160
T40	176

**MODELLO EXTRA LUNGO +25%**

### 96LBP/SC9

Serie di 9 chiavi maschio esagonale piegate con un'estremità sferica



000961354

€ 54,00  
€ 29,50

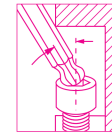

Ø mm	L mm
1,5	90
2	100
2,5	112
3	127
4	144
5	163
6	184
8	204
10	230

**MODELLO EXTRA LUNGO +30%**

### 96BP-HO/SC9

Serie di 9 chiavi maschio esagonale piegate con un'estremità sferica, con sistema di trattenimento vite



000961254

€ 50,50  
€ 24,00

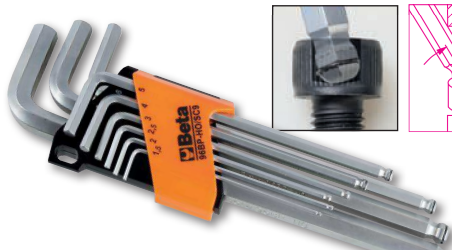

Ø mm	L mm
1,5	79
2	84
2,5	89
3	99
4	100
5	126
6	148
8	168
10	187

### 96BPA/SC9

Serie di 9 chiavi maschio esagonale piegate a 110° con estremità sferica



000961974

€ 51,50  
€ 27,00

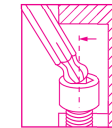

Ø mm	L mm
1,5	71
2	86
2,5	96
3	104
4	116
5	132
6	155
8	176
10	197

**MODELLO EXTRA CORTO**

**96T/55P**

Serie di 5 chiavi maschio esagonale piegate con impugnatura

000960946  
~~€ 67,50~~  
**€ 38,00**

○ 2,5-3-4-5-6 mm



**97TTX/56**

Serie di 6 chiavi maschio piegate per viti con impronta Torx® con impugnatura

000970791  
~~€ 96,00~~  
**€ 51,00**

○ T10-T15-T20  
T25-T30-T40



**951 L'ORIGINALE**

Nata per lavorare su viti ad alta resistenza, offre rapidità di manovra, precisione dell'accoppiamento con la vite e flessibilità d'impiego. L'astina scorrevole esagonale può essere regolata a piacimento. Le estremità esagonali sono calibrate per trasmettere la massima coppia possibile alla vite. La lunghezza dello stelo permette di applicare notevoli coppie alle viti senza eccessivo sforzo. I continui miglioramenti produttivi portano oggi ad avere finitura sabbata ed estremità esagonali a spigolo vivo, che permettono un accoppiamento migliore anche su viti rovinate. La marcatura eseguita a laser permette di aumentare la resistenza dello stelo.

**952 L'AFFIDABILE**

L'affidabilità e la precisione del pre-posizionamento sono le chiavi del successo di questa chiave. Lo snodo mantiene la propria funzione nel corso degli anni, senza bisogno di alcuna regolazione. Angolo di rotazione della bussola 60°. Possibilità di utilizzo a 90° in posizione fissa. Asta di manovra scorrevole, arrestabile nella posizione desiderata su tutta la lunghezza. Triplice marcatura della misura sulla testa.

**951/56**

Serie di 6 chiavi a T con 3 estremità maschio esagonale cromate

009510687  
~~€ 136,50~~  
**€ 77,00**

○ 2,5-3-4-5-6-8 mm



**952/07**

Serie di 7 chiavi a T con bussola esagonale snodata

009520079  
~~€ 263,00~~  
**€ 153,00**

○ 7-8-10-12  
13-14-17 mm



**950/06**

Serie di 6 chiavi a T semplici esagonali

○ 7-8-10-13-17-19 mm

009500096  
~~€ 181,50~~  
**€ 102,00**



# COLOR CODE

## 96BP-CL/SC9

Serie di 9 chiavi maschio esagonale piegate colorate con un'estremità sferica



000961619

€ 55,50  
€ 31,00

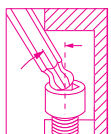

Ø mm	L mm
1,5	91
2	102
2,5	113
3	128
4	143
5	163
6	185
8	206
10	231

MODELLO  
EXTRA LUNGO +30%

## 97BTX-C/SC8

Serie di 8 chiavi maschio piegate colorate con un'estremità sferica per viti con impronta Torx®



000971658

€ 98,00  
€ 50,00

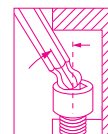

Ø mm	L mm
T9	80
T10	86
T15	90
T20	95
T25	100
T27	105
T30	114
T40	124

## 860/C38P

Assortimento di 1 portainseri con impugnatura a cricchetto reversibile, 27 inserti per avvitatori, 8 bussole esagonali e 2 accessori

- 860LP 0,6x4,5-0,8x5,5-1,0x5,5-1,2x6,5 mm
- 860PE 2-2,5-3-4(x2)-5(x2)mm
- ⊕ 860PH PH1(x2)-PH2(x2)-PH3
- ⊗ 860TX T10-T15-T20-T25-T30-T40
- ⊕ 860PZ PZ1(x2)-PZ2(x2)-PZ3
- 900 ○ 5-5,5-6-7-8-9-10-13 mm
- 892/0 ● 1/4 ■ 1/4
- 892/3 ● 1/4 ■ 1/4
- 855P ⊗ 240 mm



270x120x45 mm

008600878

€ 202,50  
€ 101,00



## 860/C27

Serie di 25 inserti colorati con raccordo e cricchetto reversibile in astuccio tascabile

- 860LP 0,5x3-1,0x5,5-1,2x6,5 mm
- 860PE 2-2,5-3-4-5-6 mm
- ⊕ 860PH PH1-PH2(x2)-PH3
- ⊗ 860TX T6-T8-T10-T15-T20-T25-T30-T40
- ⊕ 860PZ PZ1-PZ2(2x)-PZ3
- 860/55 100 mm
- 892/0 ○ 1/4 ■ 1/4



008600880

€ 96,50  
€ 54,70



## 1257LPH/S8

Serie di 8 microgiravite, lama Piatta e Phillips® in astuccio plastico rigido

- 1257PH ⊕ PH00-PH0-PH1
- 1257LP ● 0,4x2-0,4x2,5-0,5x3
- 0,6x3,5-0,8x4 mm



012570210

€ 72,50  
€ 41,00



180x120x50 mm

1243/D7

Serie di 7 giravite a batteria

1241 5,5x100-6,5x125-8x150-10x200 mm  
1242 PH1x100-PH2x100-PH3x150 mm

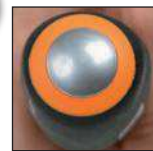

012430017

~~€ 189,00~~  
€ 62,00

1203E/D5

Serie di 5 giravite



1201E 3,5x100-5,5x150-6,5x150 mm  
1202E PH1x80-PH2x100 mm



012031001

~~€ 33,00~~  
€ 18,90

1203E/D8P

Serie di 8 giravite



1201E 2,5x50-3x75-4x100-5,5x100-6,5x150 mm  
1202E PH0x60-PH1x80-PH2x100 mm



012031018

~~€ 46,00~~  
€ 26,80

1203E/D10N

Serie di 10 giravite



1201E 2,5x50-3x75-4x100-5,5x150-6,5x150 mm  
1202E PH0x60-PH1x80-PH2x100 mm  
1201EN 4x30 mm  
1202EN PH1x30 mm



012031019

~~€ 58,50~~  
€ 33,50

1207E/TX-D7

Serie di 7 giravite



1207E/TX T6-T8-T10-T15-T20-T25-T30



012071207

~~€ 59,50~~  
€ 33,60



**Beta** **EVOLX**  
L'EVOLUZIONE DEL GIRAVITE!

**Beta** **EVOLX-E**

IL PRATICO ED ERGONOMICO  
GIRAVITE BETA EVOLX DIVENTA ELETTRICO!

SCOPRI DI PIÙ



Dati tecnici:

- Batteria al litio 3,7V 2300 mAh
- Coppia massima di serraggio in modalità elettrica 1,2 Nm
- Oltre 1.000 avvitiamenti a 1,2 Nm per ciclo di carica**
- RPM 250 giri al minuto
- Ottima resistenza statica, resiste fino a 12 Nm** (serraggio manuale)
- Ottima resistenza meccanica
- Portainseri magnetico da 1/4"
- Compatibile con tutti gli inserti standard normativi

- Ricaricabile tramite cavo USB-C (incluso)
- Presca USB-C protetta tramite tappo a vite
- LED frontali anulari per una migliore visibilità del punto di lavoro
- In fase di ricarica i 4 LED indicano lo stato di carica (25% - 50% - 75% - 100%)
- La pressione contemporanea dei due tasti, indica lo stato di carica della batteria
- Impugnatura ergonomica, in Nylon, ispirata al giravite Evox
- Tasti di funzionamento integrati e sigillati
- Comoda custodia a cintura con tasche portainseri (6 inserti misti inclusi)

1210E/GE

Giravite elettrico Evox-E con inserti

012100701

~~€ 181,50~~  
€ 102,00



6x



1211E/GE

Giravite elettrico Evox-E con inserti

012110701

~~€ 193,00~~  
€ 112,00



6x



**NEW****Morphos****IL GIRAVITE CHE SI ADATTA ALLA FORMA DELLA TUA MANO****1 IMPUGNATURA**

L'impugnatura presenta una **STRUTTURA INNOVATIVA TRIMATERICA**: il corpo in polipropilene garantisce stabilità, mentre uno **strato interno in gomma TPR ultra morbida**, posizionato nei punti di contatto con il palmo, **si deforma in modo controllato** per adattarsi alla mano e **migliorare la trasmissione e il comfort**.

**2** Sezione triangolare che **limita il rotolamento sul piano di lavoro**

**3** Texture in rilievo per un **grip superiore anche nelle condizioni di lavoro più impegnative**

**4** Identificazione immediata dell'impronta della lama sulla testa

**5** Punta fosfatata nera per un accoppiamento più preciso con la vite e una maggiore resistenza all'usura

SCOPRI DI PIÙ

**+30%****COPPIA**

Test di laboratorio interni hanno dimostrato una capacità di trasmettere **OLTRE IL 30% DI COPPIA IN PIÙ RISPETTO AI MODELLI PRECEDENTI.**

**MINOR SFORZO E PRESTAZIONI SUPERIORI IN OGNI APPLICAZIONE**

**1223/D5**

012230001

Serie di 5 giravite



1221 ● 3,5x100-5,5x150-6,5x150 mm  
1222 ● PH1x80 - PH2x100 mm

€ 53,00  
€ 29,90

**1223/D10N**

012230019

Serie di 10 giravite



1221 ● 2,5x50-3x75-4x100-5,5x150  
6,5x150 mm  
1221N ● 4x30 mm  
1222 ● PH0x60 - PH1x80 - PH2x100  
1222N ● PH1x80

€ 91,50  
€ 53,00

**1223/D6**

012230006

Serie di 6 giravite



1222 ● PH1x80 - PH2x100  
1224 ● 2,5x60-x3x100-x4x100-5x125 mm

€ 54,00  
€ 32,00

**1227TX/D7**

012270207

Serie di 7 giravite



1207E/TX ● T5-T6-T8-T10-T15-T20-T25

€ 93,50  
€ 54,20

**1223/D8P**

012230018

Serie di 8 giravite



1221 ● 2,5x50-3x75-4x100-  
5,5x100-6,5x150 mm  
1222 ● PH0x60 - PH1x80 - PH2x100

€ 73,00  
€ 42,00



**1/4** Serie di 10 inserti con portainseriti magnetico in astuccio tascabile

**861MIX/A10**

008610800

- 861LP 0,5x3-1x5,5-1,2x6,5 mm
- ⊕ 861PH PH1-PH2(x2)-PH3
- ⊕ 861PZ PZ1-PZ2-PZ3
- 882M1 ○ 1/4 ● 1/4

€ 32,50  
€ 10,20

**861PE/A10**

008610820

- 861PE 2-2,5-3(x2)-4(x2)  
5(x2)-6-8 mm
- 882M1 ○ 1/4 ● 1/4

€ 34,00  
€ 10,20

**861PHZ/A10**

008610810

- ⊕ 861PH PH1-PH2(x3)-PH3
- ⊕ 861PZ PZ1-PZ2(x3)-PZ3
- 882M1 ○ 1/4 ● 1/4

€ 32,50  
€ 10,20

**861TX/A10**

008610870

- ⊕ 861TX T7-T8-T9-T10-T15  
T20-T25-T27-T30-T40
- 882M1 ○ 1/4 ● 1/4

€ 35,00  
€ 10,20



**862F/A7**

Serie di 7 inserti a bussola esagonale magnetici, in astuccio tascabile

008620950

- 5,5-6-7-8-10-12-13 mm

€ 55,00  
€ 31,50

**862XP/A16**

Serie di 16 inserti IMPACT in astuccio tascabile

008620960

- Inserti IMPACT
- ⊕ PH2(x2)-PH3
  - ⊕ PZ2(x2)-PZ3
  - T20-T25(x2)-T30(x2)-T40(x2)
  - 4-5-6 mm

€ 73,00  
€ 38,00

**IDEALI PER  
AVVITATORI AD IMPULSI**

7x



16x



**861/C100**

Serie di 98 inserti con 2 portainseriti in astuccio

- Per avvitatori manuali, elettrici e pneumatici

008616998

€ 104,00  
€ 47,50

100x



155x117x37 mm

●	861LP	3-4-4,5-5,5(x3)-6,5(x2)-8(x2) mm
⊕	861PH	PH0(x2)-PH1(x3)-PH2(x3)-PH3(x2)-PH4
⊕	861PZ	PZ1(x3)-PZ2(x3)-PZ3(x2)-PZ4
○	861PE	2-2,5(x2)-3(x2)-4(x2)-5(x2)-6(x2)-8-10 mm
⊕	861TX	T6-T7-T8-T9-T10(x2)-T15-T20(x2)-T25(x2)-T27-T30(x2)-T40(x2)
⊕	861RTX	T6-T7-T8-T10-T15-T20-T25-T27-T30-T40
⊕	861XZN	M5-M6-M8
⊕	861TQS	0-1-2-3-4-5-6-8-10
⊕	861TRW	1-2-3-4-5-6
⊕	861SP	4-6-8-10-12
⊕	861SQ	0-1(x2)-2(x2)-3

**1256/C36-2**

Microgiravite bimatereale con 36 inserti intercambiabili da 4 mm e prolunga magnetica

012560100

4mm

€ 74,50  
€ 43,50

38x



●	1256TX	○	T3-T4-T5-T6-T7-T8-T9-T10-T15
●	1256RTX	⊕	T6-T7-T8-T9-T10
●	1256LP	○	0,8-1,2-1,5-1,8-2,2-2,5-3-3,5-4 mm
●	1256PE	○	0,7-0,9-1,3-1,5-2 mm
●	1256PH	⊕	PH000-PH00-PH0-PH1
●	1256PZ	⊕	PZ000-PZ00-PZ0-PZ1
●	1256/20		
●	1256/30		

**900/C39N**

Assortimento di 11 chiavi a bussola esagonali, 21 inserti per avvitatori e 7 accessori, in cassetta di plastica

009000947

1/4" 1/4"

€ 218,50  
**€ 123,00**



39x

150x97x53 mm

	900	5-5,5-6-7-8-9-10-11-12-13-14 mm	11
	900/20	50 mm	1
	900/20L	100 mm	1
	900/25		1
	900BG/31C	129 mm	1
	892/0	■ 1/4 - ● 1/4	1
	895/1	○ 1/4 - □ 1/4	1
	861LP	● 0,6x4,5-1,2x6,5-1,2x8 mm	3
	861PH	⊕ PH1-PH2-PH3	3
	861PZ	⊕ PZ1-PZ2-PZ3	3
	861PE	○ 2,5-3-4-5-6 mm	5
	861RTX	⊗ T10-T15-T20-T25-T27-T30-T40	7
	900/55Z	126 mm	1

**867/C52**

Serie di 52 inserti con attacco esagonale 10 mm e 2 accessori in cassetta di materiale plastico

2,1 kg 008670901

10mm

€ 147,50  
**€ 82,00**



52x

250x170x70 mm

	867PE	○ 4-5-6-7-8-10-12 mm
	867PE/L	○ 4-5-6-7-8-10-12 mm
	867XZN	○ M5-M6-M8-M10-M12
	867XZN/L	○ M5-M6-M8-M10-M12
	867TX	⊗ T20-T25-T30-T40-T45-T50-T55
	867TX/L	⊗ T20-T25-T30-T40-T45-T50-T55
	867RTX	⊗ T20-T25-T30-T40-T45-T50-T55
	867RTX/L	⊗ T20-T25-T30-T40-T45-T50-T55
	867/1	○ 10 mm - □ 3/8"
	867/2	○ 10 mm - □ 1/2"

**900/C39U**

Assortimento di 11 chiavi a bussola multimpronta, 21 inserti per avvitatori e 7 accessori, in cassetta di plastica

009001947

1/4" 1/4"

€ 219,50  
**€ 122,00**

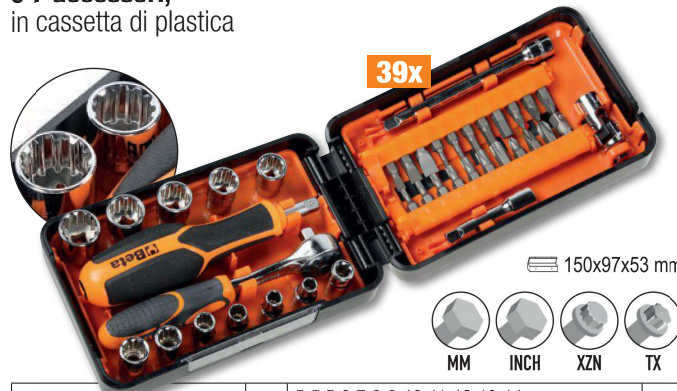

39x

150x97x53 mm



	900U	mm 5-5,5-6-7-8-9-10-11-12-13-14 mm	11
		" 13/64-7/32-1/4-9/32-5/16-11/32-3/8-7/16-15/32-1/2-9/16	
		XZN M6-M8-M10-M12-M14-M16-M18	
		FTX E7-E8-E10-E12-E14-E16-E18	
	900/20	50 mm	1
	900/20L	100 mm	1
	900/25		1
	900BG/31C	129 mm	1
	892/0	■ 1/4 - ● 1/4	1
	895/1	○ 1/4 - □ 1/4	1
	861LP	● 0,6x4,5-1,2x6,5-1,2x8 mm	3
	861PH	⊕ PH1-PH2-PH3	3
	861PZ	⊕ PZ1-PZ2-PZ3	3
	861PE	○ 2,5-3-4-5-6 mm	5
	861RTX	⊗ T10-T15-T20-T25-T27-T30-T40	7

**900/C11**

Assortimento di 11 chiavi a bussola esagonali, 20 inserti per avvitatori e 8 accessori in cassetta di lamiera

1,2 kg 009000971

1/4" 1/4"

€ 238,50  
**€ 137,00**



39x

270x120x45 mm

	861LP	● 0,5x3-0,8x5,5-1x5,5-1,2x6,5 mm
	861PE	○ 3-4-5-6-8 mm
	861PH	⊕ PH0-PH1-PH2-PH3
	861TX	⊗ T8-T10-T15-T20-T25-T30-T40
	895/1	○ 1/4" - □ 1/4"
	900	○ 5-5,5-6-7-8-9-10-11-12-13-14 mm
	900/16	□ 1/4 - ■ 3/8"
	900/20	50 mm
	900/21	150 mm
	900/25	
	900/42	
	900BG/31	177 mm

**902A/C22**

3,5 kg

009020807

Assortimento di 22 chiavi a bussola esagonali e 6 accessori, in cassetta di lamiera

14"		900	5-5,5-6-7-8-9-10-11-12-13 mm
		900/20	50 mm
		900/25	
12"		900/55	
		920A	10-13-14-15-17-18-19-22-24-27-30-32 mm
		920/21	125 mm
		920/25	
		920/55	



28x

420x185x60 mm

~~€ 382,00~~  
**€ 217,00**

**910A/C16**

2,4 kg

009100936

Assortimento di 16 chiavi a bussola esagonali e 5 accessori, in cassetta di lamiera

38"		910A	6-7-8-9-10-11-12-13-14-15-16-17-18-19-21-22 mm
		910/21	125 mm
		910/22	250 mm
		910/25	
		910/42	210 mm
		910/55	



21x

335x145x60 mm

~~€ 278,00~~  
**€ 159,00**

**920A/C17M**

5 kg

009200924

Assortimento di 17 chiavi a bussola esagonali e 5 accessori in termoformato morbido, in cassetta di lamiera

12"		920A	10-11-12-13-14-15-16-17-18-19-20-21-22-24-27-30-32 mm
		920/21	125 mm
		920/22	255 mm
		920/25	
		920/42	305 mm
		920/55	



22x

420x185x60 mm

~~€ 341,00~~  
**€ 195,00**

**928A/C12**

13 kg

009280955

Assortimento di 12 chiavi a bussola esagonali e 5 accessori, in cassetta di lamiera

34"		928A	22-24-27-30-32-34-36-38-41-46-50-55 mm
		928/21	200 mm
		928/22	380 mm
		928/25	
		928/42	450 mm
		928/55	



17x

530x220x80 mm

~~€ 982,00~~  
**€ 514,00**

## GAMMA DI CRICCHETTI BETA

LA GAMMA DI CRICCHETTI BETA SI RINNOVA E SI AMPLIA:  
SCEGLI IL MODELLO PIÙ ADATTO ALLE TUE ESIGENZE!

SCOPRI DI PIÙ



Cricchetto fino a 72 denti: angolo di ripresa di 5° per lavori in spazi limitati di manovra. Mantiene la caratteristica di avere un dentello con 17 denti, di cui 11 sempre in presa.



Ingombro minimo della testa per migliorare l'accessibilità. Quadro fosfatato.



Inversione del senso di rotazione con una sola mano.



La pressione della mano sulla testa del cricchetto non provoca inversione né sgancio accidentale della bussola.

Le versioni con attacco quadro da 1/2" e 3/4" presentano una riduzione di peso del prodotto di circa il 6%, offrendo una maneggevolezza ottimale e una facilità d'uso superiore, senza compromessi su robustezza e prestazioni.

### MATERIALI INNOVATIVI PER PERFORMANCE AL TOP

- 1 Leva dritta:** il processo di stampaggio ha origine da un semilavorato a sezione tonda, appositamente studiato per minimizzare le tensioni interne, offrendo così prestazioni ottimali.
- 2 Impugnatura ergonomica** bimateriale.
- 3 Foro sull'impugnatura** per appendibilità.

### LEVA DRITTA

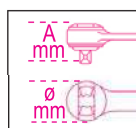

	L mm	Ø mm	A mm	■	Denti	📄	€
<b>900/55</b>	127	25	29	1/4"	72	009001155	<del>€ 49,50</del> € 27,50
<b>910/55</b>	207	31	33	3/8"	72	009101155	<del>€ 53,50</del> € 29,80
<b>920/55</b>	271	40	41	1/2"	72	009201155	<del>€ 65,00</del> € 36,00
<b>928/55</b>	504	58	59	3/4"	72	009281155	<del>€ 171,00</del> € 97,90



### LEVA PIEGATA

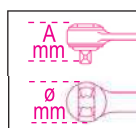

	L mm	Ø mm	A mm	■	Denti	📄	€
<b>900E/55</b>	125	26	25	1/4"	72	009001255	<del>€ 49,50</del> € 27,50
<b>910E/55</b>	204	31	33	3/8"	72	009101255	<del>€ 53,50</del> € 29,80
<b>920E/55</b>	267	40	41	1/2"	72	009201255	<del>€ 65,00</del> € 36,00

### FACILE ACCESSO ANCHE NEGLI SPAZI RISTRETTI

- 1 Leva piegata** con impugnatura rialzata rispetto al piano di lavoro, per maggiore comodità e facilità d'uso in spazi ristretti.
- 2 Impugnatura ergonomica** bimateriale.
- 3 Foro sull'impugnatura** per appendibilità.

**NEW**

# LA CHIAVE ZERO-RESET CHE NON DEVE ESSERE SCARICATA A FINE UTILIZZO

SCOPRI DI PIÙ



Anche se la chiave non viene scaricata, vengono ugualmente garantiti il numero di cicli, la durata nel tempo e la precisione di serraggio richiesta dalla normativa di riferimento. **La chiave dinamometrica Zero-Reset è stata interamente progettata e sviluppata internamente ed è prodotta presso gli stabilimenti di Beta Utensili in Italia utilizzando componentistica 100% Made in Italy.**

### TECNOLOGIA ZERO-RESET:

Grazie ai materiali più performanti e ai migliori trattamenti termici della molla e dei componenti del sistema di regolazione, non è più necessario scaricare la chiave a fine utilizzo.

### FACILITÀ DI IMPOSTAZIONE:

La scala graduata con l'aggiunta del nonio consente l'impostazione di frazioni anche minime d'intervallo, fino al decimo di Nm.

### MAGGIORE VISIBILITÀ:

Doppia scala graduata in Nm per una visibilità più chiara e semplice della coppia.



## 666

Chiavi dinamometriche a scatto ZERO-RESET con cricchetto reversibile per serraggi destrorsi, precisione di serraggio  $\pm 3\%$

UNI EN ISO 6789

14" 3/8" 12"



	Nm	■		L (mm)	g	📦	€
<b>666/2</b>	5÷25	1/4"	0,05	273	395	006660702	<del>€ 303,00</del> € 169,00
<b>666/2X</b>	5÷25	3/8"	0,05	273	405	006660703	<del>€ 303,00</del> € 169,00
<b>666/5</b>	10÷50	3/8"	0,25	342	680	006660705	<del>€ 275,00</del> € 155,00
<b>666/10</b>	20÷100	3/8"	0,25	385	760	006660710	<del>€ 277,00</del> € 156,00
<b>666/10X</b>	20÷100	1/2"	0,25	385	770	006660711	<del>€ 283,00</del> € 159,00
<b>666/20</b>	40÷200	1/2"	0,5	471	1020	006660720	<del>€ 301,00</del> € 167,00
<b>666/30</b>	60÷300	1/2"	1	600	1270	006660730	<del>€ 342,00</del> € 193,00

## 667

Chiave dinamometrica a scatto ZERO-RESET con cricchetto semplice per serraggi destrorsi e sinistrorsi, precisione di serraggio  $\pm 3\%$

UNI EN ISO 6789

12" 3/4"



	Nm	■		L (mm)	g	📦	€
<b>667/20</b>	40÷200	1/2"	0,5	471	1035	006670720	<del>€ 298,00</del> € 165,00
<b>667/30</b>	60÷300	1/2"	1	600	1285	006670730	<del>€ 338,00</del> € 182,00
<b>667/40</b>	80÷400	3/4"	1	710	2220	006670740	<del>€ 793,00</del> € 443,00

## 605E

Chiavi dinamometriche a scatto con cricchetto reversibile precisione di serraggio  $\pm 6\%$  per serraggi destrorsi e sinistrorsi



1/4"

	Nm	kgfm	lbf.in	■	L (mm)		g	📦	€
<b>605E/5</b>	1÷5	0,1÷0,5	11÷47	1/4"	190	0,05	180	006050105	<del>€ 248,00</del> € 139,00
<b>605E/10</b>	2÷10	0,2÷1,0	22÷92	1/4"	190	0,1	180	006050110	<del>€ 258,00</del> € 146,00

UNI EN ISO 6789

### 666/C2

Chiave dinamometrica a scatto ZERO-RESET in cassetta bimatrica da 14 pezzi con bussole e prolunghe

≡ 335x145x60 mm



1,6 kg 006661002

1/4" ~~€ 421,00~~  
**€ 235,00**

	⊗ 666/2	5+25 Nm
	○ 900	4+13 mm
	900/...	50-100 mm
	900/16	
	895/1	

**NEW**

### 666/C5

Chiave dinamometrica a scatto ZERO-RESET in cassetta bimatrica da 16 pezzi con bussole e prolunghe

≡ 420x185x60 mm



3 kg 006661005

3/8" ~~€ 463,00~~  
**€ 262,00**

	⊗ 666/5	10+50 Nm
	○ 910A	8+19 mm
	910/21 - 910/22	125-250 mm
	910/15	
	910/16	
	895/3	

**NEW**

### 666/C10X

Chiave dinamometrica a scatto ZERO-RESET in cassetta bimatrica da 15 pezzi con bussole e prolunghe

≡ 420x185x60 mm



3,5 kg 006661011

1/2" ~~€ 468,00~~  
**€ 262,00**

	⊗ 666/10X	20+100 Nm
	○ 920A	10+22 mm
	920/20-920/21	75-125 mm
	920/15	

**NEW**

### 666/C20

Chiave dinamometrica a scatto ZERO-RESET in cassetta metallica da 16 pezzi con bussole e prolunghe

≡ 510x180x45 mm



4,5 kg 006661020

1/2" ~~€ 513,00~~  
**€ 287,00**

	⊗ 666/20	40+200 Nm
	○ 920A	13+27 mm
	920/20-920/21 920/22	75-125-255 mm
	920/15	

**NEW**

### 666/C30

Chiave dinamometrica a scatto ZERO-RESET in cassetta metallica da 18 pezzi con bussole e prolunghe

≡ 620x180x45 mm



6,3 kg 006661030

1/2" ~~€ 603,00~~  
**€ 339,00**

	⊗ 666/30	60+300 Nm
	○ 920A	13+32 mm
	920/20-920/21 920/22	75-125-255 mm
	920/16	

**NEW**

## 599DGT-AW

Chiave dinamometrica elettronica a lettura di coppia e angolo con cricchetto reversibile e trasmissione dati wireless per serraggi destrorsi (precisione  $\pm 2\%$ ) e sinistrorsi (precisione  $\pm 3\%$ )

UNI EN ISO 6789

1/4" 3/8" 1/2"



- Tipologie di serraggio: coppia, angolo, coppia + angolo
- Doppia modalità di misura: picco e traccia
- Il raggiungimento della coppia o dell'angolo prefissati viene segnalato da avvisatori luminosi, da un suono intermittente e da vibrazione tattile
- Memorizzazione e visualizzazione delle ultime 999 letture
- 9 modalità "Preset" memorizzabili e pre-impostabili
- Tracciabilità dei dati di serraggio. Il software permette di memorizzare data e ora, numero di serie dell'utensile, valore di serraggio impostato, valore raggiunto e di associarli all'ID utente
- Possibilità di associare la chiave a uno specifico utilizzatore tramite software

- Impugnatura bimatereale antiscivolo
- Inclusi: 3 batterie AA - 1,5 V, chiavetta USB wireless e chiavetta USB software
- **Trasmissione dati wireless bi-direzionale, dalla chiave al software e viceversa, in massa a posteriori o in tempo reale**
- **Software personalizzato per elaborazione dati con riscontro OK/NG immediato e intuitivo e visualizzazione di grafici in tempo reale**

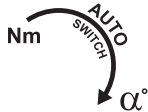

### COPPIA + ANGOLO

	Nm	kgfm	lbf.ft	■	L (mm)		g		€
<b>599DGT-AW/30</b>	6÷30	0,6÷3	4,5÷22	1/4"	410	0,1	800	005990702	<del>€ 1.166,00</del> € 659,00
<b>599DGT-AW/135</b>	27÷135	2,7÷13,5	20÷100	3/8"	445	1,0	1000	005990713	<del>€ 1.188,00</del> € 669,00
<b>599DGT-AW/340</b>	68÷340	6,8÷34	50÷250	1/2"	615	1,0	1500	005990734	<del>€ 1.265,00</del> € 689,00

SCOPRI DI PIÙ



## 605DGT/2

Chiave dinamometrica elettronica con cricchetto reversibile per serraggi destrorsi e sinistrorsi precisione di serraggio  $\pm 3\%$  destrorso  $\pm 4\%$  sinistrorso

- Doppia modalità di misura: picco e traccia
- Alimentazione con 1 batteria 1,5 V AAA (inclusa)



Nm	Kgfm	lbf.in	■	L (mm)	
4÷20	0,4÷2	35÷177	1/4"	210	0,01

UNI EN ISO 6789



175 g

006050302

1/4"

~~€ 297,00~~  
€ 165,00

## 677/C



UNI EN ISO 6789

3/4"

Chiavi dinamometriche a disinnesto con cricchetto semplice per serraggi destrorsi e sinistrorsi, precisione di serraggio  $\pm 4\%$  in cassetta

La chiave dinamometrica Beta 677/C è particolarmente adatta per gli utilizzi gravosi a elevate coppie di serraggio.



Il meccanismo a disinnesto avvisa l'operatore del raggiungimento della coppia impostata attraverso un **piegamento della chiave nel punto dello snodo di circa 20°**.



	Nm	kgfm	lbf.ft	■	L (mm)		kg		€
<b>677/C600</b>	120÷600	12÷60	100÷450	3/4"	1059	10	6,0	006770607	<del>€ 1.210,00</del> € 685,00
<b>677/C800</b>	200÷800	20÷80	150÷600	3/4"	1319	10	6,7	006770612	<del>€ 1.260,00</del> € 705,00
<b>677/C1000</b>	300÷1000	30÷100	200÷750	3/4"	1554	20	7,4	006770616	<del>€ 1.325,00</del> € 750,00

584

**Giravite dinamometrico a slittamento  
adatto a serraggi destrorsi  
precisione di serraggio ± 6%**

Impugnatura ergonomica bimateriale  
per un massimo comfort e controllo.

UNI EN ISO 6789



	Nm	gfm	Ø	mm	g	Art. No.	€
<b>584/1</b>	0,2÷1	20÷100	1/4"	0,01	266	005840201	<del>€ 334,00</del> <b>€ 189,00</b>
<b>584/5</b>	1÷5	100÷500	1/4"	0,1	346	005840206	<del>€ 334,00</del> <b>€ 189,00</b>
<b>584/10</b>	1÷5	500÷1000	1/4"	0,1	349	005840210	<del>€ 350,00</del> <b>€ 199,00</b>



**NEW**

584/C31

1,3 kg

005840931

**1 giravite dinamometrico,  
8 chiavi a bussola esagonali,  
20 inserti per avvitatori  
e 2 accessori**

1/4"

~~€ 453,00~~  
**€ 258,00**



	584/5	1÷5 Nm
	900	4-5-5,5-6-7-8-9-10 mm
	860LP	0,6x4,5-1x5,5-1,2x6,5 mm
	860PH	PH1 - PH2 (x2) - PH3
	860PE	2-2,5-3-4-5 mm
	860TX	T9-T10-T15-T20-T25-T27-T30-T40
	882P/80	80 mm
	892/0	1/4" 1/4"

270x120x45 mm

**NEW**

581/5

005810006

**Giravite dinamometrico  
a slittamento NON GRADUATO  
adatto a serraggi destrorsi  
precisione di serraggio ± 6%**

(per il settaggio della coppia usare l'art. 680)

1/4"

~~€ 297,00~~  
**€ 169,00**



Nm	gfm	Ø	UNI EN ISO 6789
1÷5	100÷500	1/4"	

**NEW**

680

CE

**Misuratore di coppia elettronico digitale  
Dynatester 680 per verifica tarature.**

- Permette la verifica della taratura dei giraviti e delle chiavi dinamometriche, funzionamento destrorso e sinistrorso
- Precisione di lettura: ± 1% del valore letto
- Display LCD a colori, 4 digit
- Fino a 12 unità di misura (Nm - lbf.ft. - lbf.in...)
- Modalità di funzionamento: Click, Dial, Track
- Possibilità di impostare 15 differenti parametri di controllo
- Dotato di cavo USB/Micro-USB per collegamento e trasmissione dati a Pc
- Compreso di alimentatore con prese EU, UK, US & AU
- Software per emissione di TEST REPORT



680/350



680/2100



680/3



680/30



	Nm	kg	Art. No.	€
<b>680/3</b>	0,1÷3	1,4	006800000	<del>€ 3.010,00</del> <b>€ 1.698,00</b>
<b>680/30</b>	1,5÷30	1,4	006800003	<del>€ 2.970,00</del> <b>€ 1.698,00</b>
<b>680/350</b>	10÷350	2,6	006800035	<del>€ 2.980,00</del> <b>€ 1.698,00</b>
<b>680/2100</b>	200÷2100	3,5	006800210	<del>€ 4.430,00</del> <b>€ 2.519,00</b>

**1150HPC**

**Pinza universale HYPERCUT con taglienti in acciaio sinterizzato M2**

- Il perno decentrato avvicina il fulcro al punto di taglio, aumentando l'effetto leva
- Il perfetto allineamento dei becchi e il profilo assottigliato garantiscono presa sicura anche in spazi molto ristretti.
- Il corpo della pinza utilizza l'affidabile acciaio al molibdeno lavorato termicamente per essere flessibile e resistente e garantire una presa sicura in ogni condizione.



011500618

~~€ 71,00~~  
**€ 38,50**

Sforzo di taglio prova statica =	<b>-73%</b>
Vita media dei taglienti = (test ISO 5744)	<b>+127%</b>
Durezza dei taglienti M2 =	<b>65HRC</b>

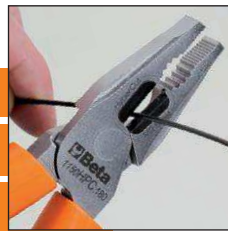

**BREVETTATA**  
**INNOVAZIONE ASSOLUTA**  
**TAGLIENTI PERFORMANTI**  
**GRANDE FORZA DI TAGLIO**



**1169BM/D3**

**Assortimento di 1 pinza universale, 1 pinza becchi mezzotondi lunghi e 1 tronchese, impugnatura bimateriale cromati**



011690133

~~€ 106,00~~  
**€ 60,50**



**1169/D3**

**Assortimento di 1 pinza universale, 1 pinza becchi mezzotondi lunghi e 1 tronchese, con 2 strati di PVC antiscivolo cromati**



011690053

~~€ 85,00~~  
**€ 49,00**



**1169N/D4**

**Assortimento di 1 pinza universale, 1 pinza becchi mezzotondi lunghi, 1 tronchese e 1 pinza a cerniera chiusa fosfatata**



011690024

~~€ 121,00~~  
**€ 69,50**



**NEW****1047N**

SCOPRI DI PIÙ

**LA PINZA CON ESCLUSIVO SISTEMA DI BLOCCO AUTOMATICO DELLE GANASCE**

DIN ISO 8976

- 1** Testa affusolata per un accesso facilitato negli spazi ristretti.
- 2** Denti temprati a induzione per una maggiore durata. Geometria e angolo dei denti studiati per una presa efficace e sicura.
- 3** Regolabile fino a 23 posizioni nella misura da 250 mm.
- 4** Maneggevolezza e comfort grazie alla sezione triangolare dei manici, per una maggiore superficie di contatto e una riduzione dello sforzo di lavoro applicato.
- 5** Manici ricoperti in PVC antiscivolo.

**MECCANISMO BREVETTATO****PER REGOLAZIONE E BLOCCO AUTOMATICO DELLE GANASCE**

L'esclusivo sistema a pulsante consente l'apertura, la chiusura e l'utilizzo della pinza anche con una sola mano.

**1047N**

	L mm	A Max mm	L1 mm	S mm	g		€
<b>1047N 180</b>	180	34	30	6	216	010470018	<del>€ 54,00</del> € 29,90
<b>1047N 250</b>	250	42	37	8	394	010470024	<del>€ 58,00</del> € 31,90
<b>1047N 300</b>	300	52	43	9	524	010470030	<del>€ 70,00</del> € 39,50

**1048N****Pinza regolabile a cerniera chiusa**

- Impugnatura a sezione triangolare per una più confortevole superficie di appoggio
- Testa affusolata per permettere l'accesso anche in spazi ristretti
- Chiodo cementato per garantire migliore resistenza all'usura
- Finitura fosfatata
- Realizzata in acciaio al Cromo-Vanadio

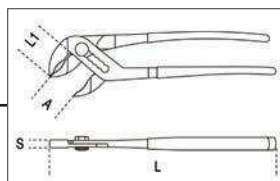

DIN ISO 8976



	L mm	A Max mm	L1 mm	S mm	g		€
<b>1048N 175</b>	175	36	31	11	189	010480910	<del>€ 33,50</del> € 19,30
<b>1048N 250</b>	250	46	38	13	354	010480915	<del>€ 36,00</del> € 20,90
<b>1048N 300</b>	300	60	44	14,8	554	010480920	<del>€ 53,50</del> € 30,50
<b>1048N 400</b>	400	96	81	19	1180	010480940	<del>€ 83,50</del> € 48,00

PROMO

**1047N/D3**

Serie di 3 pinze regolabili a pulsante

010470053

~~€ 182,00~~  
**€ 95,00****RISPARMI € 6,30**  
Rispetto all'acquisto dei prodotti sciolti**NEW**

PROMO

**1048N/D3**

Serie di 3 pinze regolabili a cerniera chiusa

010480923

~~€ 123,00~~  
**€ 66,00****RISPARMI € 4,70**  
Rispetto all'acquisto dei prodotti sciolti

**1048VN**

Pinze Poligrip, regolabili a cerniera chiusa verniciate arancio



	L mm	A Max mm	L1 mm	S mm	g		€
<b>1048VN 175</b>	175	36	31	11	189	010480111	<del>€ 28,50</del> <b>€ 16,30</b>
<b>1048VN 250</b>	250	46	38	13	354	010480116	<del>€ 32,50</del> <b>€ 18,70</b>
<b>1048VN 300</b>	300	60	44	14,8	554	010480121	<del>€ 47,50</del> <b>€ 27,30</b>

**1052**

Pinze regolabili autobloccanti ganasce concave



	L mm	∅ Max mm	g		€
<b>1052/140</b>	140	22	175	010520014	<del>€ 29,00</del> <b>€ 16,50</b>
<b>1052/190</b>	190	36	360	010520019	<del>€ 32,50</del> <b>€ 18,50</b>
<b>1052/240</b>	240	42	590	010520024	<del>€ 35,00</del> <b>€ 20,30</b>
<b>1052/300</b>	300	55	900	010520030	<del>€ 58,00</del> <b>€ 33,50</b>

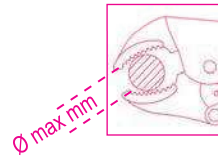

**1031/S4**

Assortimento di 4 pinze per anelli elastici di sicurezza

010310000  
~~€ 121,50~~  
**€ 68,00**



**1199ESD/D3**

Assortimento di 1 pinza per elettronica becchi piatti lunghi, 1 tronchese per elettronica a tagliente diagonale, 1 tronchese per elettronica a tagliente frontale

011990003  
~~€ 125,50~~  
**€ 71,00**



**999ESD/B4**

Serie di 4 pinzette ESD a molla antiacido e antimagnetiche



009990040  
~~€ 99,50~~  
**€ 39,50**



### 1370



Martelli tipo tedesco per meccanici,  
manico in legno

UNI 7778 DIN 1041  
**HICKORY**

	g	g		€
<b>1370/300</b>	300	439	013700053	<del>€ 16,80</del> <b>€ 9,80</b>
<b>1370/500</b>	500	669	013700055	<del>€ 20,50</del> <b>€ 11,80</b>
<b>1370/800</b>	800	949	013700058	<del>€ 27,00</del> <b>€ 15,50</b>
<b>1370/1000</b>	1000	1180	013700060	<del>€ 32,00</del> <b>€ 18,50</b>
<b>1370/1500</b>	1500	1722	013700065	<del>€ 36,50</del> <b>€ 21,00</b>
<b>1370/2000</b>	2000	2181	013700070	<del>€ 43,50</del> <b>€ 25,40</b>

### 1370T



Martelli tipo tedesco  
manico in fibra di vetro

	g	g		€
<b>1370T/300</b>	300	452	013700630	<del>€ 24,80</del> <b>€ 14,30</b>
<b>1370T/500</b>	500	663	013700650	<del>€ 27,50</del> <b>€ 16,00</b>
<b>1370T/800</b>	800	1017	013700680	<del>€ 29,00</del> <b>€ 16,80</b>
<b>1370T/1000</b>	1000	1279	013700700	<del>€ 36,50</del> <b>€ 21,00</b>
<b>1370T/1500</b>	1500	1740	013700750	<del>€ 43,00</del> <b>€ 24,80</b>

### 1390



Mazzuole con battenti intercambiabili  
in materiale plastico, manico in legno

UNI 7784

	Ø mm	g		€
<b>1390/22</b>	22	134	013900022	<del>€ 20,50</del> <b>€ 11,80</b>
<b>1390/28</b>	28	230	013900028	<del>€ 25,50</del> <b>€ 14,80</b>
<b>1390/35</b>	35	365	013900035	<del>€ 34,50</del> <b>€ 20,00</b>
<b>1390/45</b>	45	689	013900045	<del>€ 55,00</del> <b>€ 31,90</b>
<b>1390/60</b>	60	1462	013900060	<del>€ 93,00</del> <b>€ 54,50</b>

### 32AU

Bulino automatico  
con corpo brunito

- Forza d'urto regolabile fino a 50 kg
- Utilizzabile con una sola mano



000320160

~~€ 58,50~~  
**€ 33,90**

### 31/B6N

Serie di 6 cacciaspina  
in busta avvolgibile  
di poliestere resistente

Ø 2-3-4-5-6-8 mm



000310024

~~€ 72,50~~  
**€ 41,00**

### 1380T

Mazzette, manico in fibra



	A mm	L1 mm	g		€
<b>1380T 800</b>	35	85	800	013800308	<del>€ 35,50</del> <b>€ 19,60</b>
<b>1380T 1000</b>	40	100	1000	013800310	<del>€ 36,00</del> <b>€ 20,00</b>
<b>1380T 1250</b>	42	110	1250	013800312	<del>€ 38,00</del> <b>€ 20,50</b>
<b>1380T 1500</b>	45	120	1500	013800315	<del>€ 40,50</del> <b>€ 21,50</b>
<b>1380T 2000</b>	49	120	2000	013800320	<del>€ 49,50</del> <b>€ 25,80</b>

### 35/S4

Serie di 4 scalpelli nervati

L 150-200-250-300 mm



000350506

~~€ 148,50~~  
**€ 80,50**

**NEW**

**412/SP25**

Serie di 25 punte elicoidali cilindriche, in acciaio HSS, rettificate lucide

Ø 1÷13 x 0,5 mm

R ≤ 800 N/mm<sup>2</sup>  
HV ≈ 750÷820  
DIN 338



≡ 110x190x55 mm



004120425

~~€ 202,00~~  
**€ 116,00**



**415CO/SP19**

Serie di 19 punte elicoidali cilindriche serie corta, in acciaio HSS-CO 5%, rettificate

Ø 1÷10 x 0,5 mm

R ≤ 1200 N/mm<sup>2</sup>  
HV ~ 800÷860  
DIN 338



≡ 115x170x40 mm

**Co5%**



004150421

~~€ 185,00~~  
**€ 60,00**



**416/SP19**

Serie di 19 punte in HSS con affilatura speciale a doppio cono di penetrazione

Ø 1÷10 x 0,5 mm



≡ 115x170x40 mm



004160419

~~€ 141,50~~  
**€ 80,00**



**416G/SP25**

Serie di 19 punte elicoidali cilindriche serie corta, in acciaio HSS rettificate

Ø 1÷13 x 0,5 mm

R ≤ 900 N/mm<sup>2</sup>  
HV ~ 820÷850

**VELOCITÀ  
DI TAGLIO  
SUPERIORE**



≡ 110x190x55 mm

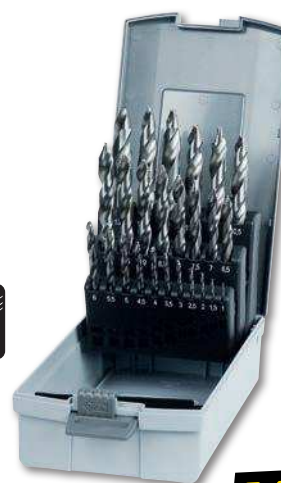

004160525

~~€ 399,00~~  
**€ 232,00**



**NEW**

**425ES/SP3**

Serie di 3 frese coniche a gradino, elicoidali con geometria a gradino scorrevole, in acciaio HSS-G

Ø 4÷12 ; 4÷20 ; 4÷30 mm

R ≤ 900 N/mm<sup>2</sup>  
HV 800



004250800

~~€ 245,00~~  
**€ 143,00**



≡ 98x158x18 mm

**NEW**

**437P**

Ravvivafiletti per ripristino di filettature interne ed esterne, destre e sinistre

- P 0,80-1,00-1,25-1,50-1,75-2,00-2,50-3,00 mm



230 mm

004370003

€ 51,00  
€ 28,80

**437U/09**

Assortimento per il ripristino delle filettature danneggiate

- M5X0,8
- M6X1,0
- M8X1,25
- M10X1,5
- M12X1,75



370x230x55 mm

2 kg

004370550

€ 371,00  
€ 213,00

**450/C21**

Assortimento di seghe a tazza con accessori per uso industriale in cassetta metallica



21x

Co8%

420x280x60 mm

7 kg

004500315

€ 773,00  
€ 412,00

	450	Ø 19-22-29-35-38-44-51-57-64-76 83-92-95-105-114 mm
	450AL	/1 - /2
	450PA	/1 - /2
	450PR	
	450AD	

**446/C110**

Assortimento di 105 maschi e filiere con 5 accessori in acciaio al cromo, filettatura metrica, in cassetta di legno

- 435/0 444/1 436/1
- 435/3 444/2



500x337x60 mm

8,1 kg

004460060

€ 952,00  
€ 514,00

I	III	III	III
430 M mm	433 M mm	440/440A M mm	441/441A M mm
2x0,4	6x0,75 - 7x0,75	2x0,4	6x0,75 - 7x0,75
3x0,5	8x0,75 - 8x1	3x0,5	8x0,75 - 8x1
4x0,7	9x0,75 - 9x1	4x0,7	9x0,75 - 9x1
5x0,8	10x0,75 - 10x1	5x0,8	10x0,75 - 10x1
6x1	10x1,25 - 11x0,75	6x1	10x1,25 - 11x0,75
7x1	11x1 - 11x1,25	7x1	11x1 - 11x1,25
8x1,25	12x0,75 - 12x1	8x1,25	12x0,75 - 12x1
9x1,25	12x1,25 - 12x1,5	9x1,25	12x1,25 - 12x1,5
10x1,5	14x1 - 14x1,25	10x1,5	14x1 - 14x1,25
11x1,5	14x1,5 - 16x1	11x1,5	14x1,5 - 16x1
12x1,75	16x1,5 - 18x1,5	12x1,75	16x1,5 - 18x1,5
14x2		14x2	
16x2		16x2	

**1599F**

Morse parallele da banco forgiate

Interamente in fusione di acciaio.

- Ganasce fresate e temprate in superficie
- Apertura anteriore
- Elevata profondità di serraggio.

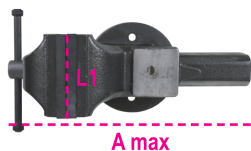

	L mm	BxH mm	Ø mm	A max mm		€
<b>1599F/100</b>	100	92x46	11	125	015990100	€ 355,00 € 205,00
<b>1599F/125</b>	125	108x54	13	150	015990125	€ 454,00 € 256,00
<b>1599F/150</b>	150	125x62	13	200	015990150	€ 638,00 € 360,00
<b>1599F/175</b>	175	140x70	15	220	015990175	€ 878,00 € 493,00

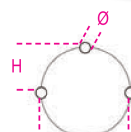

Beta  
POWERTOOLS

SCOPRI DI PIÙ



**1972/K12V-10**

2,3 kg

019720112

**Trapano avvitatore ultracompatto 12 V**

- Doppia velocità meccanica con ingranaggi in acciaio e frizione a 20 posizioni
- Coppia fino a 30 Nm e 1300 giri/min (400 giri/min in 1ª marcia); fora fino ad un diametro di 10 mm nell'acciaio e 20 mm nel legno
- Batterie da 2 Ah e indicatore di carica sul corpo macchina
- Impugnatura ergonomica antiscivolo
- LED frontale
- Mandrino autoserrante da 10 mm
- Clip da cintura destra/sinistra
- Selettore avvita-svita-blocco (per il trasporto)
- **Fornito in valigetta rigida con 2 batterie agli ioni di litio da 2 Ah e caricatore rapido (50 min)**



316x254x96 mm

€ 276,00  
**€ 99,00**



**Ultracompatto:** solo 170 mm di lunghezza;  
**Ultralleggero:** solo 1,1 kg con batteria e perfettamente bilanciato

**1972/K20V+SMER**

019720024

**Kit completo 20V trapano a percussione + corpo macchina smerigliatrice in BMC**

Composto da:

- **1972/K20V-13BMC**

Trapano a percussione Brushless 20V da 80 Nm, mandrino autoserrante da 13 mm, doppia velocità.

**Fornito in valigetta rigida con 2 batterie da 4 Ah e caricatore rapido.**

- **1986/20V-125BMC**

Smerigliatrice angolare Brushless 20V con interruttore a slitta, diametro disco 125/115 mm, protezione contro riavvio accidentale, copri disco "tool-less", impugnatura supplementare.

**Fornita in valigetta rigida senza batterie e caricatore, solo corpo macchina.**



490x370x125 mm

490x370x125 mm



€ 847,00  
**€ 319,00**

PROMO



**RISPARMI € 89,00**

Rispetto all'acquisto dei prodotti sciolti

**NEW**

**ACQUISTA 6 CONFEZIONI (300 PZ.)  
DI DISCHI ABRABETA **AL PREZZO PROMO!****

**Ø 115 mm - TAGLIO FERRO**



**A36S** DISCHI DA TAGLIO  
DI SPESSORE SOTTILE  
Centro Piano

~~€ 540,00~~  
**€ 290,00**  
(€ 0,97 cad.)



**INCLUSA PER TE**

la smerigliatrice  
**Beta 1956 115-750W**  
del valore netto di **€ 45,00**

**750W**



	Diametro	Spessore	N° pz.	
<b>300 AB000010115+750W</b>	115	1,0	300 pz	110010300
<b>300 AB000010117+750W</b>	115	1,2	300 pz	110010302
<b>300 AB000010119+750W</b>	115	1,6	300 pz	110010301

**Ø 125 mm - TAGLIO FERRO & INOX**



**A46U** DISCHI DA TAGLIO  
DI SPESSORE SOTTILE  
Centro Piano

~~€ 795,00~~  
**€ 440,00**  
(€ 1,47 cad.)



**INCLUSA PER TE**

la smerigliatrice  
**Beta 1956 125-1400W**  
del valore netto di **€ 99,00**

CON REGOLATORE  
DI VELOCITÀ **1400W**



	Diametro	Spessore	N° pz.	
<b>300 AB000330125+1400W</b>	125	1,0	300 pz	110330320
<b>300 AB000330126+1400W</b>	125	1,2	300 pz	110330322
<b>300 AB000330128+1400W</b>	125	1,6	300 pz	110330321

**332**

**Mini-tagliatubi per rame e leghe leggere**



	L mm	Ø mm / "		€
<b>332</b>	59	3÷16 1/8"÷5/8"	003320001	<del>€ 25,50</del> <b>€ 14,50</b>
<b>332/2</b>	63	3÷28 1/8"÷1"1/8"	003320003	<del>€ 28,50</del> <b>€ 16,30</b>

**342**

**Cesoia a cricchetto per tubi in materiale plastico**

003420030  
~~€ 57,00~~  
**€ 32,90**



**376**

**Giratubi modello svedese ganasce piane a 90°**



	L mm	Ø"	Ø mm		€
<b>376 320</b>	320	1" gas	34	003760032	<del>€ 53,50</del> <b>€ 30,40</b>
<b>376 410</b>	410	1 1/2" gas	49	003760041	<del>€ 78,00</del> <b>€ 40,00</b>
<b>376 550</b>	550	2" gas	60	003760055	<del>€ 109,00</del> <b>€ 61,00</b>
<b>376 630</b>	630	3" gas	90	003760063	<del>€ 198,50</del> <b>€ 112,00</b>

**363**

**Giratubi modello americano con corpo in lega leggera e ganasce in acciaio forgiato**



	L mm	Ø"	Ø mm		€
<b>363 350</b>	350	2" gas	60	003630035	<del>€ 72,50</del> <b>€ 42,00</b>
<b>363 450</b>	450	2 1/2" gas	76	003630045	<del>€ 98,00</del> <b>€ 56,50</b>
<b>363 600</b>	600	3" gas	90	003630060	<del>€ 165,50</del> <b>€ 96,00</b>
<b>363 900</b>	900	5" gas	140	003630090	<del>€ 318,00</del> <b>€ 180,00</b>
<b>363 1200</b>	1200	6" gas	165	003630120	<del>€ 329,00</del> <b>€ 190,00</b>

**1750KG10**

**10 kg** 017500100

**Ingrassatore a leva da 10 kg con tubo ad alta pressione da 2 m**

~~€ 210,50~~  
**€ 121,00**

- Dotato di raccordo girevole per non strozzare il tubo
- Corpo pompante in alluminio pressofuso con valvola di sfianto

3 differenti livelli di pressione impostabili:  
- 4 gr a 275 bar  
- 7 gr a 206 bar  
- 9 gr a 137 bar

Dimensioni fusto:  
Altezza 312,5 mm  
Diametro interno 220 mm  
Diametro esterno 224 mm



**345SB**

003450010

**Sbavatore a raschietto a lama intercambiabile girevole**

~~€ 25,50~~  
**€ 14,50**

- Per tubi in rame, leghe leggere e PVC
- Fornito con 2 lame



**1750**

017500500

**Compressori a leva per grasso, 500 cc**

~~€ 47,00~~  
**€ 27,00**



## RIVETTATRICI

Ø mm	1741TR						1741						1740B 280						1740B 330						1741U											
	2,4	3,2	4	4,8	5	6,4	2,4	3,2	4	4,8	5	6,4	2,4	3,2	4	4,8	5	6,4	2,4	3,2	4	4,8	5	6,4	2,4	3,2	4	4,8	5	6,4						
ALLUMINIO	•	•	•	•	X	X	•	•	•	•	•	X	•	•	•	•	X	X	•	•	•	•	•	•	•	•	•	•	•	•	•	•	•	•	X	X
ACCIAIO	•	•	•	X	X	X	•	•	•	•	•	X	•	•	•	•	X	X	•	•	•	•	•	•	•	•	•	•	•	•	•	•	•	X	X	X
INOX	•	•	•	X	X	X	•	•	•	X	X	X	•	•	•	•	X	X	•	•	•	•	•	•	•	•	•	•	•	•	•	•	•	X	X	X

### 1741TR

Rivettatrice con testa rotante fornita con 4 testine intercambiabili

- Testa rotante a 360° per operare in ambienti di difficile accesso.

017410410  
~~€ 44,50~~  
**€ 23,80**

### 1740B

Rivettatrice di potenza compatta

- Rapporto di leva ottimizzato per una maggiore compattezza e praticità d'uso.
- Testa regolabile per tirare il rivetto da 2 a 5 movimenti dei bracci

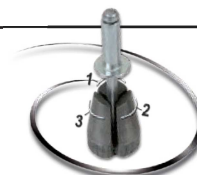

**3 GRIFFE:  
MIGLIOR PRESA  
DEL RIVETTO**



**SERBATOIO  
PORTASTELI**



	L mm	g		€
<b>1740B 280</b>	280	650	017400280	<del>€ 81,00</del> <b>€ 46,50</b>
<b>1740B 330</b>	330	1000	017400330	<del>€ 93,50</del> <b>€ 54,50</b>

### 1741

Rivettatrice fornita con 4 testine intercambiabili

017410003  
~~€ 48,50~~  
**€ 22,60**

### 1741U

Rivettatrice ultra compatta con regolazione dello sforzo fornita con 4 testine intercambiabili

017410450  
~~€ 58,50~~  
**€ 28,70**



**3 GRIFFE:  
MIGLIOR PRESA  
DEL RIVETTO**



**COMPATTA E LEGGERA  
NELL' UTILIZZO**

# RICARICA WIRELESS

SCOPRI DI PIÙ



	LUMEN	BATTERIA	TEMPO DI RICARICA	AUTONOMIA	IP/IK
<b>1833XSW</b>	80 - 250 (LED SMD)	3,7V 700 mAh, 2.59 Wh Li-ion	2h 1839BRW o cavo	2 - 8h	IP54; IK07
<b>1833MW</b>	5 - 30 - 400 - 1000 (LED SMD)	3,7V 2.600 mAh, 9.62 Wh Li-ion	6h 1839BRW 4h cavo	2- 200h	IP68; IK07
<b>1836AW</b>	30 - 200 - 400 (principale LED COB) 400 (spot LED COB)	3.7 V, 1500 mAh, 5.55 Wh Li-ion	2,5h 1839BRW o cavo	Principale: 4-18h Spot: 4h	IP65; IK07
<b>1836BW</b>	225 - 250 - 500 (principale + spot 500 lumen LED SMD) 20 (luce rossa LED SMD)	3.6V, 3000 mAh Li-ion	6h 1839BRW 4,5h cavo	Principale + spot : 2.5h Principale: 4h Spot: 4h Luce Rossa: 18h	IP65; IK06

## 1833XSW

**Torcia a LED per ispezioni con ricarica wireless**

- Magneti su base e retro
- Clip da cintura
- Cavo USB incluso



018330011

~~€ 51,00~~  
**€ 29,40**



## 1833MW

**Torcia a LED ad alta luminosità con ricarica wireless**

- 4 intensità luminose
- Magnete sul retro
- Cavo USB incluso



018330013

~~€ 93,00~~  
**€ 53,00**



## 1836AW

**Lampada da testa a LED con ricarica wireless**

- Doppia emissione luminosa
- Cavo USB incluso



018360051

~~€ 76,50~~  
**€ 44,50**



## 1836BW

**Lampada da testa ricaricabile a LED, con luce rossa e sensore ON/OFF contactless, wireless**

- Sensore ON/OFF contactless
- Cavo USB-C incluso
- Indicatore del livello di batteria a 4 led



018360201

~~€ 99,00~~  
**€ 55,00**



**NEW**

## RICARICA WIRELESS ((o))

	LUMEN	BATTERIA	TEMPO DI RICARICA	AUTONOMIA	IP/IK
<b>1838/13LED-W</b>	430 (frontale LED SMD) 90 (spot LED SMD)	3,6V, 6.000 mAh Li-Ion	10,5h 1839BRW 5h cavo	Principale + spot : 4h Principale: 5h Spot: 10h	IP65; IK07
<b>1838SW</b>	250 - 500 - 1000 (frontale LED COB) 200 (spot LED SMD)	3,6V 3.350 mAh Li-ion	6,5h 1839BRW 4,5h cavo	Principale: 2-8h Spot: 7h	IP65; IK07
<b>1838POCKET</b>	160 - 400 - 800 (principale LED COB) 250 (spot LED SMD)	3,7V 2.600 mAh Li-ion	4,5h 1839BRW 4h cavo	Principale: 3-9h Spot: 4,5h	IP65; IK07

**1838/13LED-W**

018380112

Lampada ricaricabile con LED ad alta luminosità, wireless

- Doppia emissione luminosa
- Cavo USB-C incluso
- Indicatore del livello di batteria
- Gancio orientabile
- 1 magnete sulla base
- 2 magneti laterali
- Indicatore del livello di batteria a 4 led



€ 149,00  
**€ 85,00**

**NEW****1838SW**

018380142

Lampada snodata ricaricabile a LED con ricarica wireless

- Doppia emissione luminosa
- Base orientabile a 180°
- Corpo in gomma antiscivolo
- Doppio gancio orientabile
- Magneti su base e retro
- Cavo USB incluso



€ 103,50  
**€ 59,00**

**1838POCKET**

018380080

Faretto tascabile snodato a LED con ricarica wireless

- Doppia emissione luminosa
- Angolo illuminante: luce principale 160°, luce spot 18°
- Orientabile a 210°
- Corpo in gomma antiscivolo
- Base magnetica
- Cavo USB incluso



€ 72,50  
**€ 41,50**

**1839BRW**

018390002

Base di ricarica wireless, compatibile con lampade 1833XSW, 1833MW, 1836AW, 1836BW, 1838/13LED-W, 1838SW, 1838POCKET

- Due posizioni di ricarica, con attacco magnetico, utilizzabili contemporaneamente
- Con supporto estraibile per ricarica wireless telefono cellulare
- Led per indicare lo stato di ricarica
- Max input 10W x2
- Input: AC 100-240V 50/60Hz
- Output: DC 12V 1.5A / DC 9V 2A / DC 5V 3A
- Attacco USB-C
- Per consentire la ricarica simultanea delle due posizioni, utilizzare i cavi inclusi:
  - cavo QC3.0 USB-C fast charger (1839/R5)
  - caricatore QC3.0 USB-C fast charger (1839/R6)
- IP20
- IK07



€ 98,00  
**€ 57,00**



- Appendibile a parete tramite: 3 forti magneti sul retro 2 fori per viti



## KIT WIRELESS ((◉◉))

Il kit wireless permette di avere in un'unica soluzione prodotti con diverse funzionalità offrendo una postazione di ricarica più comoda e ordinata.

### 1839W/P1

018390800

**Kit lampade wireless**  
1833MW, 1836AW con base  
di ricarica compatibile 1839BRW

€ 267,00  
**€ 135,00**

- Torcia a led ad alta luminosità con ricarica wireless **1833MW**
- Lampada da testa a led con ricarica wireless con doppia emissione luminosa **1836AW**
- Base di ricarica wireless **1839BRW** compatibile con le lampade del kit



### 1839W/P2

018390805

**Kit lampade wireless 1838SW,**  
1838POCKET con base di ricarica  
compatibile 1839BRW

€ 274,00  
**€ 138,00**

- Lampada snodata a led con ricarica wireless **1838SW**
- Lampada tascabile snodata a led, orientabile, con doppio fascio luminoso, ricaricabile con ricarica wireless **1838POCKET**
- Base di ricarica wireless **1839BRW** compatibile con le lampade del kit



**RISPARMI**  
**€ 19,50**

Rispetto all'acquisto  
dei prodotti sciolti

**NEW**

### 1838FLASHPRO

018380301

**Faretto ricaricabile ultracompatto,**  
studiato per offrire la migliore  
soluzione possibile in ogni utilizzo

€ 230,00  
**€ 129,00**

- **3 intensità luminose:**  
LED SMD 1200 - 1000 - 800 lumen
- Batteria ricaricabile:  
Li-Ion, 3.6V, 10.000 mAh
- Ricaricabile con alimentatore  
con attacco USB-C
- Cavo USB-C e alimentatore incluso
- Indicatore del livello  
di batteria a 4 led
- Tempo di ricarica: 7,45h
- Autonomia: 1200 Lumen 8,5h  
1000 Lumen 9,5h  
800 Lumen 11,5h
- Gancio orientabile a 360°
- Magnete removibile sulla base
- IP65; IK07



### 1838AM

018380400

**Lampada da ispezione**  
ricaricabile a LED

€ 115,50  
**€ 63,00**

- **2 emissioni luminose:**  
frontale: LED COB, 80-800 lumen,  
regolabile con potenziometro  
spot (testa): LED SMD, 120 lumen,  
interruttore ON-OFF
- Con attacco USB-C
- Fornita con caricatore 100-240V / 50-60Hz
- Tempo di ricarica: 4 h
- Autonomia: frontale: 2.5-16 h  
spot (testa): 10 h
- Indicatore livello di batteria a 3 led
- Base magnetica (con magnete al neodimio)  
orientabile a 90°
- Gancio orientabile alla base
- IP54; IK07

- Snodata e orientabile a 180°  
(± 90° rispetto all'asse)

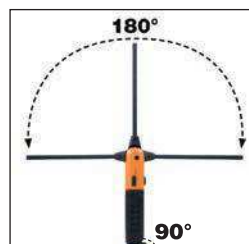

**NEW**

### 1838SLIM

Lampada sottile a 3 LED snodata ricaricabile

- **3 emissioni luminose:**  
Frontale: 100/200 lumen  
Posteriore: 180 lumen  
Spot (testa): 80 lumen
- Base magnetica
- Tempo di ricarica: 2,5 h
- Autonomia:  
2-3,5 h / spot 3 h
- IP54; IK07
- L 307 mm



### 1838F

Lampada ricaricabile magnetica a LED con testa flessibile e doppia emissione luminosa

- **2 emissioni luminose:**  
principale: LED COB 50 - 500 lumen  
spot (testa): LED SMD, 120 lumen
- Batteria ricaricabile:  
Li-Ion 3.7 V, 2600 mAh
- Ricarica con attacco USB-C
- Cavo USB-C incluso
- Tempo di ricarica: 4h
- Autonomia:  
- principale: 22-2h  
- spot: 9h
- Magnete sulla base
- Gancio pieghevole a 90°
- Indicatore livello batteria a 3 led
- IP54; IK07



### 1838CLAMP

Faretto ricaricabile a pinza con fascio di luce orientabile, con 4 intensità luminose, ricaricabile

- **4 intensità luminose:**  
1600 lm - Modalità ultra high  
700 lm - Modalità high  
300 lm - Modalità low  
100 lm - Modalità eco
- Batteria ricaricabile  
Li-Ion 3.7 V, 5200 mAh
- Ricaricabile con cavo USB-C incluso
- Orientabile a 315°
- Tempo di ricarica 3,5h
- Autonomia:  
3h - Modalità ultra high  
5h - Modalità high  
8,5h - Modalità low  
24h - Modalità eco
- Indicatore livello di batteria a 3 led
- Con pinza integrata, si aggancia ovunque con facilità
- 1 magnete sul retro
- IP65; IK07



**NEW**

### 1838PN

Lampada a LED a penna ricaricabile

- **2 emissioni luminose:**  
principale e spot
- **3 intensità luminose:**  
principale COB LED 350 - 175  
Lumenspot: SMD LED 120 Lumen
- Batteria ricaricabile:  
Li-Ion 3.7 V, 1600 mAh
- Tempo di ricarica: 2,5 h
- Autonomia:  
- principale: 6/3 h  
- spot: 6 h
- Base magnetica
- Clip da cintura/taschino magnetica
- Cavo USB-C incluso
- IP65; IK07



### 1838COMPACT

Lampada a LED compatta ricaricabile

- **2 emissioni luminose:** principale e spot
- **3 intensità luminose:**  
principale COB LED 300 - 120 Lumen  
spot SMD LED 150 Lumen
- Batteria ricaricabile:  
Li-Ion 3.7 V, 1500 mAh
- Tempo di ricarica: 2,5h
- Autonomia: principale: 7/3,5 h  
spot: 6 h
- Clip da cintura/taschino
- Cavo USB-C incluso
- IP65; IK07



### 1691MG

Flessometri con magnete fisso  
cassa bimateriale in ABS antiurto  
nastro in acciaio classe di precisione II

	L m	S mm		€
<b>1691MG/5</b>	5	25	016910405	<del>€ 15,80</del> € 8,80
<b>1691MG/8</b>	8	25	016910408	<del>€ 22,00</del> € 12,30
<b>1691MG/10</b>	10	25	016910410	<del>€ 23,30</del> € 13,40



### 1650

Calibro a corsoio  
lettura ventesimale

- Lettura ventesimale
- Bloccaggio a molla

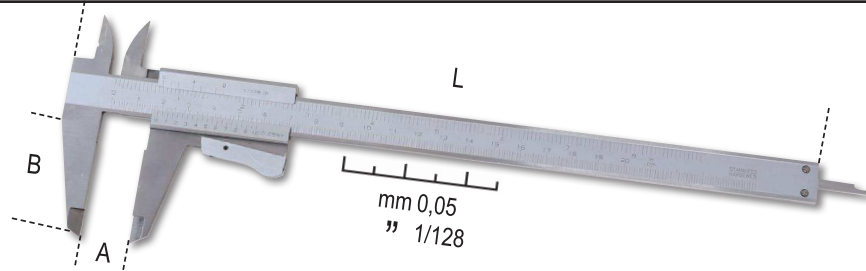

	A Max mm	L mm	B mm	G mm		€
<b>1650/150</b>	150	235	40	0,05-1/128	016500001	<del>€ 66,50</del> € 38,50
<b>1650/200</b>	200	290	49	0,05-1/128	016500002	<del>€ 87,50</del> € 50,40

DIN 862  
UNI EN ISO 13385-1



### 1651DGTB

Calibro digitale a corsoio  
lettura centesimale

- Lettura centesimale
- Bloccaggio a vite del corsoio
- Conversione mm/pollici
- Azzeramento in ogni posizione
- Asta di profondità quadra fino a 300 mm
- In astuccio rigido di materiale plastico

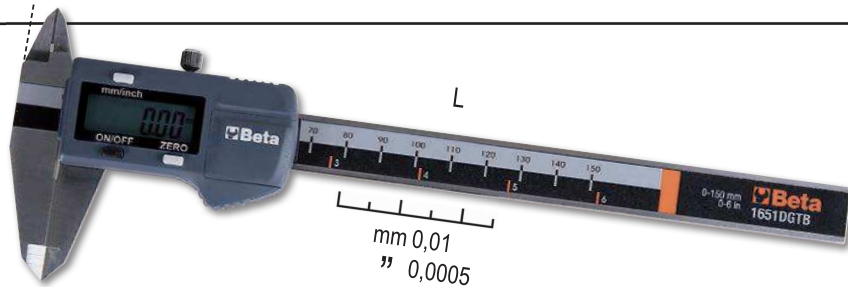

	A Max mm	L mm	B mm	G mm		€
<b>1651DGTB 150</b>	150	235	40	0,01-0,0005	016510211	<del>€ 112,50</del> € 65,00
<b>1651DGTB 200</b>	200	285	50	0,01-0,0005	016510212	<del>€ 146,50</del> € 84,50
<b>1651DGTB 300</b>	300	400	60	0,01-0,0005	016510213	<del>€ 191,00</del> € 111,00

DIN 862  
UNI EN ISO 13385-1

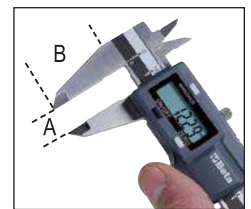

### 1695XS

Livella tascabile con base a "V"  
magnetica in alluminio profilato  
2 filee infrangibili  
precisione 1mm/m

- Ideale per tubi e sezioni tonde in genere
- Fornita con clip



 016950250  
~~€ 14,10~~  
€ 8,10

### 1687/S4

Serie di 4 punte di precisione  
con impugnatura

 016870150  
~~€ 28,00~~  
€ 15,00



## 1693L 40

Misuratore di distanza laser, multifunzione, 40 METRI con livelli di posizionamento

**MISURAZIONI:**

- Misura di distanza singola
- Misura continua o misurazione minima

**FUNZIONI:**

- Addizione/sottrazione
- Misura dell'area
- Misura del volume
- Misura indiretta variabile (misurazione pitagorica)
- Misura inclinazione
- Auto spegnimento
- Durata batteria: fino a 5.000 misurazioni
- Custodia morbida in tela (inclusa)

**DATI TECNICI:**

- Campo di misurazione: da 0,05 a 40 m (da 0.2 in a 131 ft)
- Selezione scala: m, in, ft
- Precisione:  $\pm 1,5$  mm ( $\pm 0.06$  in)
- Classe Laser: 2
- Memorizzazione misure: 99
- Batterie: AAA 2 x 1.5V

**LIVELLE DI POSIZIONAMENTO**



40 m

016930040  
~~€ 163,50~~  
**€ 94,90**

IP54  
 CE  
 115 mm  
 25 mm  
 50 mm

## 1693M 80

Misuratore di distanza laser, multifunzione, 80 METRI

**MISURAZIONI:**

- misura di distanza singola
- misura continua o misurazione minima

**FUNZIONI:**

- Addizione/sottrazione
- misura dell'area
- misura del volume
- misurazione indiretta variabile (misurazione pitagorica)
- Misurazione inclinazione
- Auto spegnimento
- Durata batteria: fino a 4.000 misurazioni
- Custodia morbida in tela (inclusa)

**DATI TECNICI:**

- Campo di misurazione: da 0,05 a 80m (da 0.2in a 229f)
- Selezione scala: m, in, ft
- Precisione:  $\pm 1,5$  mm ( $\pm 0.06$  in)
- Classe Laser: 2
- Memorizzazione misure: 99
- Batterie: AAA 2 x 1.5V



80 m

016930080  
~~€ 228,00~~  
**€ 133,00**

IP54  
 CE  
 115 mm  
 29 mm  
 48 mm

## 1696T

Livelle con base magnetica in alluminio profilato con 3 file infrangibili

- Base profilata a V
- Precisione 0,5 mm/m
- Completa di finestra per lettura verticale



	L mm	H mm	S mm		€
<b>1696T 600</b>	600	66	28	016960506	<del>€ 82,50</del> <b>€ 46,50</b>
<b>1696T 800</b>	800	66	28	016960508	<del>€ 91,50</del> <b>€ 51,50</b>
<b>1696T 1000</b>	1000	66	28	016960510	<del>€ 97,00</del> <b>€ 54,50</b>
<b>1696T 1200</b>	1200	66	28	016960512	<del>€ 128,50</del> <b>€ 67,90</b>

**1760/IR500**

**Termometro digitale ad infrarossi con doppio puntamento laser**

017600350  
~~€ 174,50~~  
**€ 98,50**



**500 °C**



**DATI TECNICI**

Range temperatura: -50 ÷ 500 °C (-22 a 932 °F)  
 Risoluzione display: 0,1  
 Emissività: regolabile 0,1 ÷ 1  
 Precisione: -50 a 20 °C (+/- 3 °C);  
 20 ÷ 500 °C (+/-2% o 2 °C)  
 Risoluzione ottica (D:S): 12:1  
 Auto Spegnimento: circa 10 secondi  
 Temperatura di funzionamento: 0 ÷ 50 °C  
 Temperatura di stoccaggio: -20 ÷ 60 °C  
 Alimentazione: 1 batteria 9V

**1760PA/AC-DC**

**Pinza amperometrica e multimetro digitale**

017600000  
~~€ 363,00~~  
**€ 205,00**



**1000 A**



**PARAMETRI RILEVABILI**

Tensione DC: 0.1mV ÷ 600V  
 Tensione AC: 0.1mV ÷ 600V  
 Corrente DC: 0.01 A ÷ 1000 A  
 Corrente AC: 0.01 A ÷ 1000 A  
 Resistenza: 0.1Ω ÷ 40MΩ  
 Capacità: 0.001nF ÷ 40 μF  
 Frequenza: 0.001kHz ÷ 4kHz  
 Temperatura: -40 °C ÷ 1000 °C  
 -40 °F ÷ 1832 °F

**1760/RMS**

**Multimetro digitale industriale con gomma esterna antiscivolo ed antiurto**

017600020  
~~€ 325,00~~  
**€ 188,00**

- Ingressi protetti
- Autoranging
- Ampio display di immediata lettura, retroilluminato blu
- Terminali a doppio isolamento 1000V, lunghezza 1 m
- Sonda temperatura tipo K (inclusa)
- Autospegnimento
- Base in gomma portaterminale per un maggiore comfort durante l'uso
- In custodia morbida
- CAT IV 600V/ CAT III 1000V
- Vero valore efficace TRUE RMS



**IP67**

	<b>Campo di misura</b>	<b>Precisione base</b>
Tensione AC/DC	110mV - 600V ±0.8%	- ±2% rdg
Corrente AC/DC	110μA - 10A ±1.5%	- ±2% rdg
Resistenza	110Ω - 40MΩ ±1.2%	- ±2.5% rdg
Capacità	11nF - 40mF ±5%	- ±10% rdg (fino a 11mF)
Frequenza	1100Hz - 110 MHz ±1.2%	- ±1.5% rdg
Temperatura	-32 °C - +1000 °C ±3%	- ±5% rdg
Test diodi	3V dc ±10% rdg	
Test continuità	<30 Ω	

**1760S**

**Multimetro digitale compatto, con lettura a valore efficace TRUE RMS**

017600022  
~~€ 93,50~~  
**€ 54,50**

- Protezione IP40
- Autoranging
- Ampio display di immediata lettura, retroilluminato blu
- Autospegnimento
- Indicazione batteria scarica
- In custodia morbida
- CAT III 600V
- Vero valore efficace TRUE RMS



**IP40**

**Parametri rilevabili:**  
 Tensione DC: 200 mV-2/20/200/600V  
 Tensione AC: 100/600V  
 Corrente DC: 200 mA-10 A  
 Corrente AC: 0,01-10 A  
 Resistenza: 200Ω - 2/20/200 kΩ - 2 MΩ  
 Test diodi: da 0.4 a 0.7 V dc  
 Alimentazione: 2 batterie 1,5V tipo AAA



**1608**

**Pinza per capicorda preisolati, con regolatore di pressione**

016080001  
~~€ 132,50~~  
**€ 76,30**

0,5÷6 mm<sup>2</sup>



**1606T**

**Pinza per capicorda a tubetto, crimpatura su 4 lati**

016060005  
~~€ 344,00~~  
**€ 184,00**

0.1÷10 mm<sup>2</sup>



**16091/C6**

016090300

Pinza crimpatrice  
con 6 matrici intercambiabili

€ 215,00  
€ 125,00

**6in1**



REGOLABILE,  
CON SGANCIO  
RAPIDO

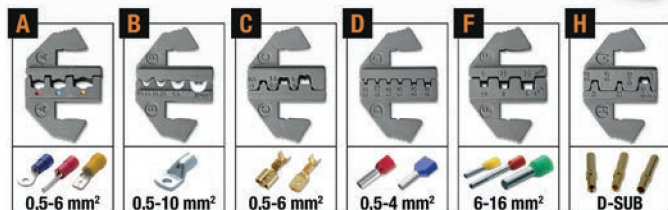

**6 differenti tipologie di matrici:**

- per capicorda preisolati ad occhio, a puntale e rapidi maschio da 0,5 a 6 mm<sup>2</sup>
- per capicorda non isolati da 0,5 a 10 mm<sup>2</sup>
- per capicorda non isolati femmina e maschio da 0,5 a 6 mm<sup>2</sup>
- per capicorda preisolati a tubetto da 0,5 a 4 mm<sup>2</sup>
- per capicorda preisolati a tubetto da 6 a 16 mm<sup>2</sup>
- per capicorda non isolati tipologia D-SUB

**NEW**

**1149F**

011490010

Pinza spellafili frontale  
autoregolabile,  
con dispositivo di taglio

€ 19,20  
€ 11,10

- Adattamento automatico ai diametri dei conduttori
- Lunghezza della spellatura regolabile
- Regolazione della pressione di taglio isolante
- Dispositivo di taglio integrato



0,2÷6 mm<sup>2</sup>

**1609B**

4,2 kg

016090101

Pinza crimpatrice  
meccanica

€ 352,00  
€ 199,00

- Per capicorda in rame non isolati da 10 a 120 mm<sup>2</sup>
- Impugnatura in gomma antiscivolo
- Perno interno con sezione ad "H" per la massima scorrevolezza del punzone
- In acciaio brunito

10÷120 mm<sup>2</sup>



L 600 mm

**1128 X-PRO**

BM1325

Forbici per elettricisti  
lame corte e gola spellacavi

€ 45,00  
€ 25,50

- Lame in acciaio INOX
- Gola tagliacavo
- Con microdentatura su un tagliente
- Sistema a molla per apertura facilitata



MONO-OCCHIELLO

**NEW**

**1128 X-PRO EVO**

BM1330

Forbici per elettricisti  
lame corte e gola spellacavi

€ 40,00  
€ 22,80

- Lame in acciaio INOX
- Gola tagliacavo
- Con microdentatura su un tagliente
- Sistema a molla per apertura facilitata



CON OCCHIELLO  
APERTO

**NEW**

# 1778MT

## L'UTENSILE MULTIFUNZIONE COMPLETO DI INSERTI

SCOPRI DI PIÙ



### 1778MT

Utensili multifunzione completi di inserti e fodero

9 utensili per un totale di 22 funzioni:

- Pinza universale
- Lama grande
- Lama ondulata
- Seghetto
- Lima
- Apriscatole/Apribottiglie
- Forbici
- Portainseri
- Giravite per viti con impronta Phillips®

**ADATTO AD OGNI SITUAZIONE!**



11 bits + bussola + pinzetta



Righello 100 mm / 4 pollici

017780055

€ 108,00  
€ 59,90

**PRO WILD**  
PROGETTATO PER OGNI NECESSITÀ!



Estrazione accessori facilitata



Pulsanti sblocco utensili

### 1726N

Seghetto rivestito con sistema di tensionamento della lama incorporato nell'impugnatura

- Impugnatura in lega di alluminio rivestito in bi-materiale
- Vano porta lama
- Lama inclinabile a 55° e a 90°



**NEW**

017260040

€ 39,00  
€ 23,00



### 1729MF

Seghetto multifunzione

- Lama per metallo da 24 TPI
- Lama per cartongesso da 6 TPI
- Doppia lama per plastica da 11 TPI e per legno da 16 TPI

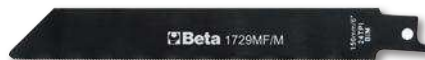

017290500

€ 26,00  
€ 14,60

### 1772M

Cutter a lama retrattile di sicurezza fornito con 4 lame

- Lama con rientro automatico a molla
- Corpo in lega pressofusa
- Levapunti integrato nel manico



017720040

€ 20,40  
€ 11,80

### 1771BM

Cutter 18 mm fornito con 6 lame

- Impugnatura bimatereale antiscivolo
- Caricamento automatico della lama nuova
- Ghiera bloccalama per la massima stabilità della lama sotto sforzo
- Cursore di sicurezza antiritorno



017710050

€ 22,40  
€ 12,90

**1778SOS**

**Coltello soccorso auto con funzione martello frangicristallo e tagliacinture di sicurezza**, in astuccio

- Con clip e custodia in tessuto con passacintura
- Impugnatura in alluminio anodizzato
- Blocco lama di sicurezza



017780080  
~~€ 36,00~~  
**€ 19,90**

**1128FXS**

**Forbici elettricista con svasatore, lame in acciaio inossidabile con microdentatura, gola tranciacavo e crimpatore per terminali a tubetto**

- Custodia agganciabile alla cintura
- Impugnatura bimateriale
- Perno anti-allentamento



**Profilo a fresa:** studiate per allargare fori su plastica da 13 a 21 mm



011280095  
~~€ 42,00~~  
**€ 24,00**

**1128BAX**

**Forbici per elettricisti a doppio effetto, con profili a fresa in acciaio inossidabile rivestito in DLC**

- Alta durezza superficiale delle lame (resistenza all'abrasione e mantenimento dell'affilatura nel tempo)
- Basso coefficiente di attrito (scorrevolezza e potenza di taglio)
- Fornite con custodia plastica snodata

011280088  
~~€ 36,50~~  
**€ 20,50**



**+DUREZZA  
 -COEFFICIENTE  
 D'ATTRITO**



**Profilo a fresa:** studiate per allargare fori su plastica da 13 a 25 mm

**1128BSX**

**Forbici per elettricisti in acciaio inox con profili a fresa graduata**

- Studiate per allargare fori su scatole di derivazione in plastica e chiudere tubi corrugati
- Custodia agganciabile alla cintura
- Impugnatura bimateriale
- Perno antiallentamento



**BREVETTATA**

011280061  
~~€ 33,50~~  
**€ 19,00**

**1128BMX**

**Forbici per elettricisti lame dritte in acciaio inossidabile con microdentatura**

- Lame in acciaio INOX dritte
- Gola tagliafilo
- Con microdentatura su un tagliente



011280051  
~~€ 19,50~~  
**€ 11,20**

**1600Q 10**

**Chiave snodabile a doppia croce per quadristi**

- Quadro da 5 / 6-7 / 8-9 mm
- Triangolo da 5-6-7 / 8-9 / 10 mm
- Alette 3-5 mm
- Esagono 1/4"
- Quadro maschio 1/4"



125 mm

SCOPRI DI PIÙ



**1134S**

011340030

**Tagliacavi a cricchetto**

- Brunito con manici in PVC antiscivolo
- Il dispositivo demoltiplicatore consente di esercitare sforzi elevati con l'utilizzo di una sola mano.

~~€ 155,00~~  
**€ 89,90**



L mm	mm	mm <sup>2</sup>
255	32	400



**NEW**

**1134B**

011340050

**Tagliacavi a cricchetto**

- Brunito con manici in PVC antiscivolo
- Il dispositivo demoltiplicatore consente di esercitare sforzi elevati con l'utilizzo di una sola mano.

~~€ 215,00~~  
**€ 125,00**



L mm	mm	mm <sup>2</sup>
275	53	500



**NEW**

**NEW**

**IL KIT IDEALE PER ELETTRICISTI**

**1233MQF/D4-FX**

012330905

**Serie di quattro giraviti slim con forbice per elettricisti 1128FX**

Composto da:

- 1233MQF/D4

Serie di 4 giravite isolati slim  
1234MQF/LP ● 4x100-5,5x125 mm  
1232MQF ⊕ PH1x75-PH2x100 mm

- 1128FX

Forbici per elettricisti lame dritte in acciaio inossidabile con microdentatura, gola tranciacavo e crimpatore per terminali a tubetto

~~€ 91,00~~  
**€ 49,00**



## 1233MQF/D6

Serie di 6 giravite isolati slim

1234MQF/LP ● 3x100-4x100-5,5x125 mm  
1232MQF ⊕ PH0x60-PH1x75-PH2x100 mm

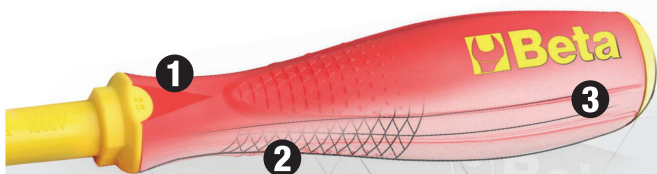

Il giravite presenta tre aree funzionali:

- ① una zona di precisione esagonale per un controllo accurato,
- ② una zona di velocità circolare con texture per una rotazione rapida e un diametro del -25% rispetto alla serie 1273MQ
- ③ una zona di serraggio triangolare per applicare maggiore forza.

012330606  
€ 78,50  
**€ 43,00**

EN 60900



**NEW**

## 1273MQ/D6

Serie di 6 giravite isolati

1274MQ ● 3x100-4x100-5,5x125 mm  
1272MQ ⊕ PH0x60-PH1x80-PH2x100 mm



012730851  
€ 76,50  
**€ 44,50**

EN 60900



## 1128MQ

Forbici per elettricisti  
lame in acciaio inossidabile  
con microdentatura

011280101

€ 55,00  
**€ 32,00**

△ 1000 V

IEC 60900



## 1169MQ/D2

Assortimento di 1 pinza  
universale isolata  
e 1 tronchese isolato

011690152

€ 118,50  
**€ 61,00**



1150MQ 180 mm

1082MQ  
160 mm

△ 1000 V

EN 60900



## 920MQ/C16

Assortimento di 9 chiavi a bussola esagonali  
3 chiavi a bussola esagonali maschio  
e 4 accessori in cassetta di lamiera

5,2 kg

009200917

€ 1.021,00  
**€ 515,00**

	920MQ/A	○ 8-10-12-13-14-17-19-22-24 mm
	920MQ/21	135 mm
	920MQ/22	264 mm
	920MQ/55A	
	920MQ/T	
	920MQ/PE	○ 5-6-8 mm

12"



16x

△ 1000 V

IEC 60900



**GLI UTENSILI BETA INOX POSSONO ESSERE STERILIZZATI IN AUTOCLAVE A 121°C**

**CO4TSS/7**

**Cassettiera mobile con 7 cassetti in acciaio inossidabile**

- 7 cassetti da 570 x 410 mm montati su guide telescopiche a sfera; 6 cassetti altezza 83 mm 1 cassetto altezza 170 mm
- Quattro ruote antitraccia con nucleo in acciaio inossidabile Ø 125mm
- 2 fisse e 2 girevoli (due con freno)
- Serratura frontale centralizzata
- Struttura esterna in acciaio inossidabile AISI 430
- Maniglia cassetti in alluminio
- Ruote, supporti, sfere, interno dei cassetti e relative guide in acciaio inossidabile



63 kg

024003077

€ 2.910,00  
**€ 1.569,00**

n°	Max
6	83 mm 25 kg
1	170 mm 30 kg

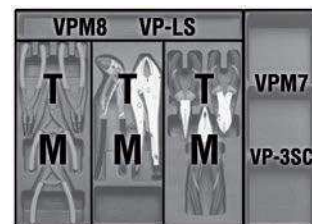
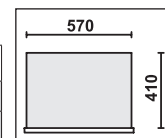

**C20TSS**

**Cestello estendibile a cinque scomparti in acciaio inossidabile AISI 304, vuoto**

Può essere utilizzato in ambienti critici, ovvero zone e aree in cui non è ammesso il livello minimo di contaminazione, resiste alla ruggine e ai principali acidi ed è sterilizzabile in autoclave a 121° C.

Ambienti critici in cui può essere impiegato:

- Industria alimentare
- Produzione farmaceutica - classe C
- Applicazioni marine
- Laboratori biotecnologici e biomedici

450x200x210 mm



4 kg

021203001

€ 326,00  
**€ 175,00**

**42INOX/SC8**

**Serie di 9 chiavi combinate in acciaio inossidabile con supporto compatto**

8-10-11-12-13  
14-15-17-19 mm

000420388

€ 196,00  
**€ 115,00**



**NEW**

**96TINOX/S8**

**Serie di 8 chiavi maschio esagonale piegate con impugnatura di manovra in acciaio inossidabile**

Ø 2,5-3-4-5-6-7-8-10 mm

000961954

€ 159,50  
**€ 82,90**

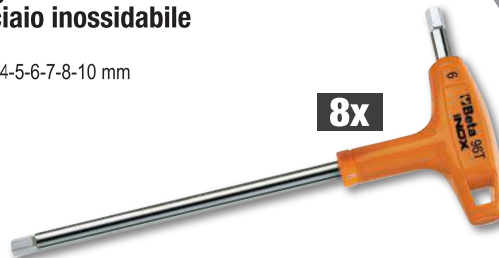

8x

**1203INOX/D8**

**Serie di 8 giravite in acciaio inossidabile**

1290INOX ● 2,5x50-3x75-4x100-5,5x150-6,5x150 mm  
1292INOX ⊕ PH0x60-PH1x80-PH2x100 mm

012030408

€ 116,00  
**€ 49,00**



**Beta** *evox*

**NEW**

**PROMO**

## 9710/B6

097100840

~~€ 59,00~~  
**€ 35,90**

**Sbloccante lubrificante multiuso 7 funzioni**

1. Sbloccante;
2. Lubrificante;
3. Detergente;
4. Protettivo antiruggine;
5. Disossidante per contatti elettrici;
6. Idrorepellente;
7. Anticongelante.

Non contiene silicone.

**LUBRIBETA**

**BOX 6 PEZZI**



**5+1**  
**INCLUSO NEL PREZZO**

**PROMO**

## 9752/B6

097520840

~~€ 54,00~~  
**€ 32,90**

**Zinco chiaro**

Con elevato potere coprente, è ideale per zincare parti in ferro, ritocchi di saldatura, dadi, bulloni e parti sottoposte al deterioramento di agenti atmosferici. Particolarmente resistente a ossidazione e abrasione. Fortemente adesivo, crea un film elastico di colore molto chiaro, simile alla zincatura a caldo. Può essere sovra-verniciato. Ideale anche come protettivo finale. Non cola.

**ZINC 98%**

**BOX 6 PEZZI**



**5+1**  
**INCLUSO NEL PREZZO**

## 9841R

098410020

~~€ 28,00~~  
**€ 14,50**

**RED SEAL**

**Guarnizione siliconica rossa,** resistente ad alte temperature, con pratico erogatore a pressione (pressure pack)

Ideale per porte di forni, piastre, sistemi di riscaldamento, scarichi, termostati, pompe, tubi di riscaldamento, parti motore non soggette ad alte pressioni e tutte le applicazioni dove è necessaria una resistenza alle alte temperature.

**RESISTE FINO A 300°C**

200 ml



## 9841N

098410120

~~€ 29,50~~  
**€ 15,50**

**BLACK SEAL**

**Guarnizione siliconica nera,** resistente ad alte temperature, con pratico erogatore a pressione (pressure pack)

Ideale per coppe olio, pompe olio, carter, scatole cambio, parti motore non soggette ad alte pressioni e applicazioni che necessitano di resistenza ad alte temperature.

**RESISTE FINO A 240°C**

200 ml



## 1749AC

017490005

~~€ 42,00~~  
**€ 24,50**

**Pistola ad alta spinta per ancoranti chimici e cartucce standard**



230 mm  
STANDARD Ø 50 mm

## 1749A

017490010

~~€ 47,50~~  
**€ 27,50**

**Pistola per sigillante modello professionale tubo in alluminio, per cartucce e sacchetti**



# AVVOLGITORI

Tutti gli avvolgitori sono forniti di una staffa orientabile di 180° e di una seconda staffa da fissare a muro per l'aggancio/sgancio rapido dell'avvolgitore.

SCOPRI DI PIÙ



## AVVOLGICAVO

- Lunghezza cavo fuori scocca 1 m
- Cremagliera disinseribile per cavo sempre in trazione
- 15 m di cavo arrotolato

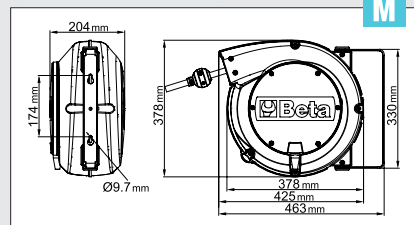
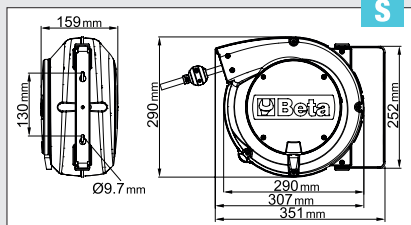

### 1842 15-H05/LED

018420821

Avvolgitore automatico completo di lampada a LED, 100-240Vac

€ 364,00  
€ 185,00

- Con trasformatore di sicurezza 230/12V
- Cavo H05VV-F 2x1,0 mm<sup>2</sup>

S



### 1844 15-H05

Avvolgitore automatico con cavo 3Gx1,5 mm<sup>2</sup>

- Cavo 3Gx1,5 mm<sup>2</sup>
- Con protettore termico
- Potenza max. arrotolata 1500W (230V-20 °C)
- Potenza max. srotolata 2500W (230V-20 °C)

S

15 m



1844 15-H05

Avvolgitore senza cavo in entrata + cavo libero



1844 15-H05/SCK

Avvolgitore con spina e presa SCHUKO



1844 15-H05/3SCK

Avvolgitore con spina e 3 prese SCHUKO

### 1845 15-H07

018450367

Avvolgitore automatico con cavo 3Gx2,5 mm<sup>2</sup> (H07RN-F)

€ 488,00  
€ 249,00

- Cavo 3Gx2,5 mm<sup>2</sup>
- con protettore termico
- Potenza max. arrotolata 2000W (230V-20 °C)
- Potenza max. srotolata 3000W (230V-20 °C)

M



15 m

**NEW**

		€	€
1844 15-H05	018440315	€ 237,00	€ 119,00
1844 15-H05/SCK	018440316	€ 247,00	€ 125,00
1844 15-H05/3SCK	018440319	€ 245,00	€ 129,00

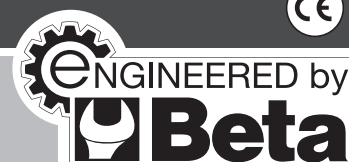

## AVVOLGITUBO

- Pressione di utilizzo massima 15 bar
- Tubo in Poliuretano retinato
- Temperatura di utilizzo -5 °C/+50 °C

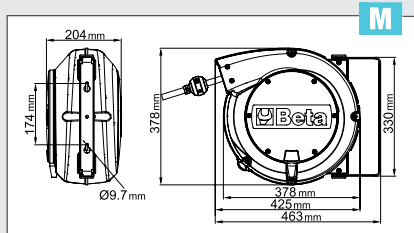
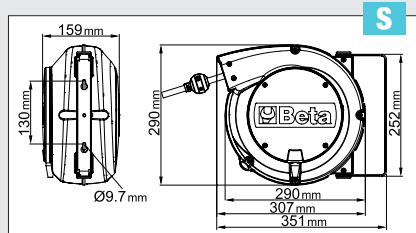
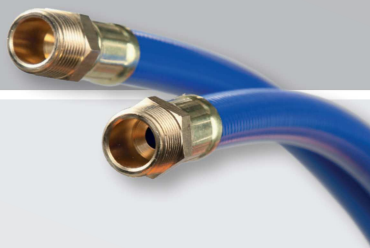

### 1900S 8X10

Avvolgitubo automatico  
Tubo Ø 8x12 mm da 10 m

019000080

~~€ 183,00~~  
**€ 79,80**

### 1900M 8X15

Avvolgitubo automatico  
Tubo Ø 8x12 mm da 15 m

019000085

~~€ 250,00~~  
**€ 109,00**



Ø GAS BSP 1/4"



Ø GAS BSP 1/4"

### 1900M 10X15

Avvolgitubo automatico  
Tubo Ø 10x14 mm da 15 m

019000115

~~€ 261,00~~  
**€ 119,00**

### 1900M 12X15

Avvolgitubo automatico  
Tubo Ø 12x16 mm da 15 m

019000125

~~€ 340,00~~  
**€ 159,00**

- 3 raccordi per utilizzo con acqua



Ø GAS BSP 3/8"



Ø GAS BSP 1/2"



**IDEALE PER  
AVVITATORI DI  
GRANDE POTENZA**

### 1547/C6

#### Estrattori per cuscinetti con false sfere

Cuscinetti:  
**1547/1**  
 6011-6014, 6206-6211, 6303-6308,  
 6403-6405  
**1547/2**  
 6004-6010, 6200-6205, 6300-6304

- Utilizzabile solo dopo aver "sgabbiato" le sfere



≡ 420x185x60 mm

3 kg 015470006

~~€ 318,00~~  
**€ 174,00**



### 1545/CSM

#### Estrattore 1542/1 con 5 espansori 1544

2,4 kg 015450011

~~€ 602,00~~  
**€ 342,00**



≡ 265x180x45 mm

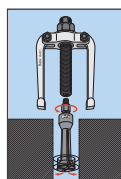

	A mm	C mm
1544/1	9+12	0,80
1544/2	13+17	1,15
1544/3	16+21	1,70
1544/4	20+25	1,65
1544/5	25+30	2,00



### 1430/SS

014300105

#### Estrattori conici per viti e prigionieri destrorsi danneggiati in acciaio legato

M3÷M18  
 1430/1-1430/2-1430/3  
 1430/4-1430/5

~~€ 28,00~~  
**€ 16,50**



≡ 110x150x40 mm

### 1500N

#### Estrattori universali a 2 griffe

- Il particolare disegno della griffa permette un bloccaggio automatico della stessa sotto carico
- Impiego sia per esterni che per interni
- Griffe mobili lungo la traversa

	A min+max mm	L mm	L1 mm	● mm	A1 mm		€
<b>1500N/0</b>	18+65	70	100	15	110	015000600	<del>€ 82,50</del> <b>€ 47,40</b>
<b>1500N/1</b>	23+70	100	130	17	130	015000601	<del>€ 86,00</del> <b>€ 49,40</b>
<b>1500N/2</b>	23+100	100	130	17	160	015000602	<del>€ 93,00</del> <b>€ 53,40</b>
<b>1500N/3</b>	35+140	150	190	20	230	015000603	<del>€ 155,00</del> <b>€ 89,60</b>
<b>1500N/4</b>	35+190	150	190	20	280	015000604	<del>€ 167,00</del> <b>€ 95,90</b>
<b>1500N/5</b>	43+250	205	295	27	360	015000605	<del>€ 321,00</del> <b>€ 184,00</b>
<b>1500N/6</b>	43+320	205	295	27	430	015000606	<del>€ 348,00</del> <b>€ 201,00</b>

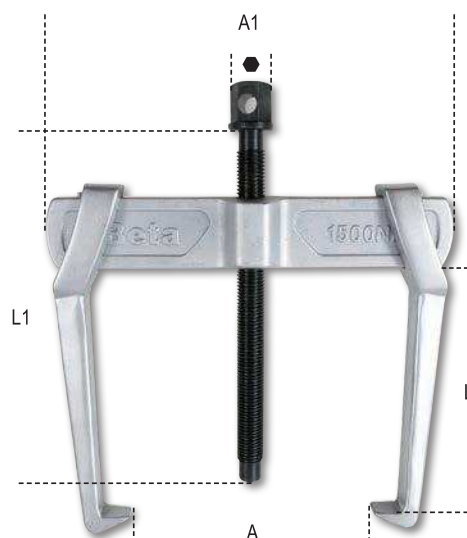

**1852R1750/N**

**Riscaldatore ad induzione portatile,**  
in valigetta di plastica

- Riscalda e sblocca bulloni, dadi, mozzi e cuscinetti particolarmente bloccati senza l'utilizzo di fiamme
- Permette di scaldare qualsiasi tipo di metallo ferromagnetico

**Dati tecnici:**

- Tensione di ingresso: 230V AC, 50/60 Hz
- Corrente di ingresso: max. 7,5 A
- Potenza: max. 1.75 kW

**VANTAGGI**

- 1 Risparmio di tempo: riscaldamento veloce e con grande precisione
- 2 Sicurezza anti incendio: non genera fiamme, massima sicurezza per l'operatore
- 3 Praticità: utilizzabile con una sola mano e serpentine facilmente intercambiabili

**CAMPI DI APPLICAZIONE**

- Automotive
- Manutenzione industriale
- Industria aeronautica
- Industria navale
- Industria petrolchimica



**5 kg**      **018520176**

€ 1.615,00  
**€ 899,00**



**▶ NUOVA SERPENTINA AGGIUNTA ALLA VALIGETTA**  
dal valore di listino di € 122,00

Una serpentina a contatto	
Due serpentine frontali con diametro 19 e 26 mm per sblocco dadi	
Una serpentina piatta per scaldare le superfici	
Una serpentina flessibile lunga 800 mm	

**NEW**

**1852RL3700**

**Riscaldatore ad induzione portatile da 3,7kW con liquido di raffreddamento**

Il riscaldatore a induzione portatile raffreddato a liquido, è la soluzione ideale per il riscaldamento rapido ed efficiente di materiali ferromagnetici e conduttivi. Grazie all'induttore da 2 metri offre una straordinaria versatilità d'uso, adattandosi a diverse esigenze di lavoro.

**Dati tecnici:**

- Tensione di ingresso: U1 230 V 50/60 Hz
- Corrente di ingresso: I1 16 A
- Potenza: max: P2max 2400 W

**VANTAGGI**

- 1 Risparmio di tempo: riscaldamento veloce e con grande precisione
- 2 Sicurezza anti incendio: non genera fiamme, massima sicurezza per l'operatore
- 3 Praticità: utilizzabile con una sola mano e serpentine facilmente intercambiabili

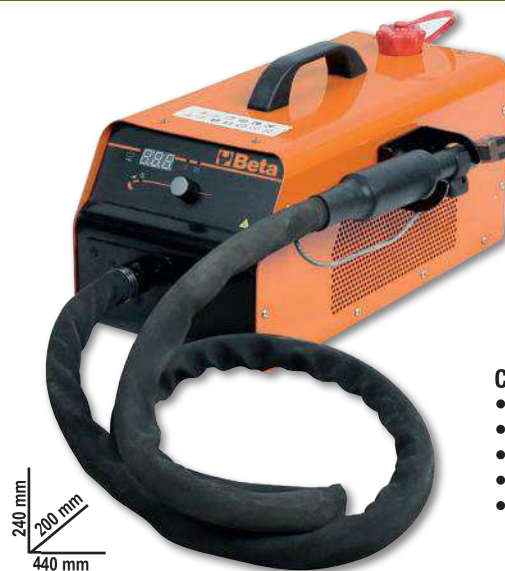

**11,5 kg**      **018520370**

€ 5.780,00  
**€ 2.599,00**

**CAMPI DI APPLICAZIONE**

- Automotive
- Officine/riparazione di veicoli
- Industria ferroviaria e navale
- Installazione di riscaldamento e condutture
- Manutenzione generale

**NEW**

**961N**

**Videoscopio elettronico con sonda flessibile ed orientabile**

- Schermo TFT LCD 5"
- Supporta l'utilizzo di SD CARD
- Registrazione video ed immagini
- 4 led di illuminazione
- Alimentazione tramite presa USB (batteria incorporata)
- Sonda orientabile
- Alta risoluzione
- Lunghezza sonda: 1 m
- Diametro sonda : 6 mm

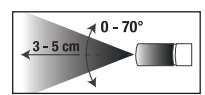
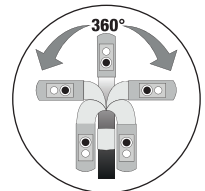

**009610030**

€ 494,00  
**€ 285,00**



**1895**

**Vasca di lavaggio ad ultrasuoni**  
con funzione speciale di degassificazione

- Attraverso il riscaldamento del liquido e con l'azione degli ultrasuoni permette di pulire efficacemente parti di ricambio e pezzi metallici in genere (iniettori, carburatori, valvole, ecc...)
- Display digitale con regolazione della temperatura e del tempo di lavaggio
- Doppia funzione lavaggio: "soft" e "normal"
- Per una pulizia generale è sufficiente usare acqua ad una temperatura di 50/60 °C
- Per una pulizia più accurata aggiungere soluzioni detergenti non schiumogene specifiche per vasche ad ultrasuoni
- La funzione degassificazione accelera la liberazione d'aria in tutto il volume della vasca aumentando l'efficacia degli ultrasuoni

	<b>1895 6</b>	<b>1895 13</b>	<b>1895 27</b>	<b>1895 157</b>
Capacità vasca	6 litri	13 litri	27 litri	157 litri
Rubinetto di scarico	✓	✓	✓	✓
Potenza	150 Watt	300 Watt	500 Watt	2160 Watt
Potenza di riscaldamento	300 Watt	400 Watt	500 Watt	5000 Watt
Regolazione temperatura	0+80 °C	0+80 °C	0+80 °C	30+110 °C
Regolazione tempo di lavaggio	0-99 minuti	0-99 minuti	0-99 minuti	0-59 minuti
Frequenza	40 kHz	40 kHz	40 kHz	28 kHz - 40 kHz
Alimentazione	220/230V	220/230V	220/230V	220/380V
Dimensioni	330x180x310 mm	350x325x320 mm	530x330x380 mm	840x640x750 mm
Dimensioni serbatoio	300x155x150 mm	325x235x145 mm	500x300x200 mm	700x500x450 mm



		€
<b>1895 6</b>	018950060	<del>€ 783,00</del> <b>€ 449,00</b>
<b>1895 13</b>	018950130	<del>€ 1.215,00</del> <b>€ 689,00</b>
<b>1895 27</b>	018950270	<del>€ 1.690,00</del> <b>€ 969,00</b>

**157 LITRI**  
**1895 157** 018950357 ~~€ 7.780,00~~ **€ 4.119,00**

**1898/C**

**Nebulizzatore carrellato da 25 litri**

- Doppia funzione: nebulizzatore o schiumogeno
- Serbatoio in acciaio verniciato
- Lancia in acciaio inossidabile
- Tubo antitorsione
- Manometro di controllo per la pressione del serbatoio
- Indicatore di livello serbatoio

**Dati tecnici:**

- Capacità serbatoio: 25 l
- Lunghezza Tubo erogazione: 5 m
- Pressione max di lavoro: 4-5 bar
- Lunghezza lancia 0,65 m
- Pressione massima serbatoio: 8 bar



018980940  
~~€ 268,00~~  
**€ 163,00**

**1889N**

**Base in acciaio per movimentazione e stoccaggio di 2 fusti da 200 l**

- Verniciata completamente a caldo a polvere epossidica
- Facilmente trasportabile con carrello elevatore a forche o transpallet
- Supporto non sovrapponibile
- Capacità vasca 235 l



330 mm  
1740 mm  
1210 mm

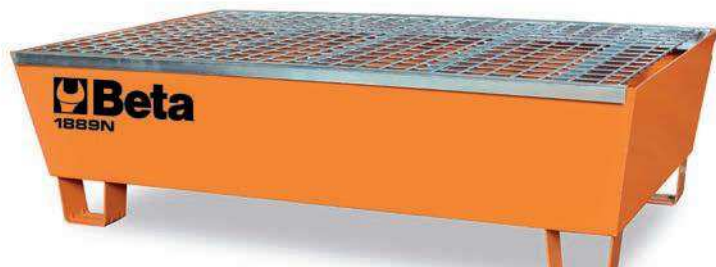

018890220  
~~€ 879,00~~  
**€ 365,00**



# 3027N

## PRESSE IDRAULICHE CON PISTONE MOBILE



Pressa idraulica da banco

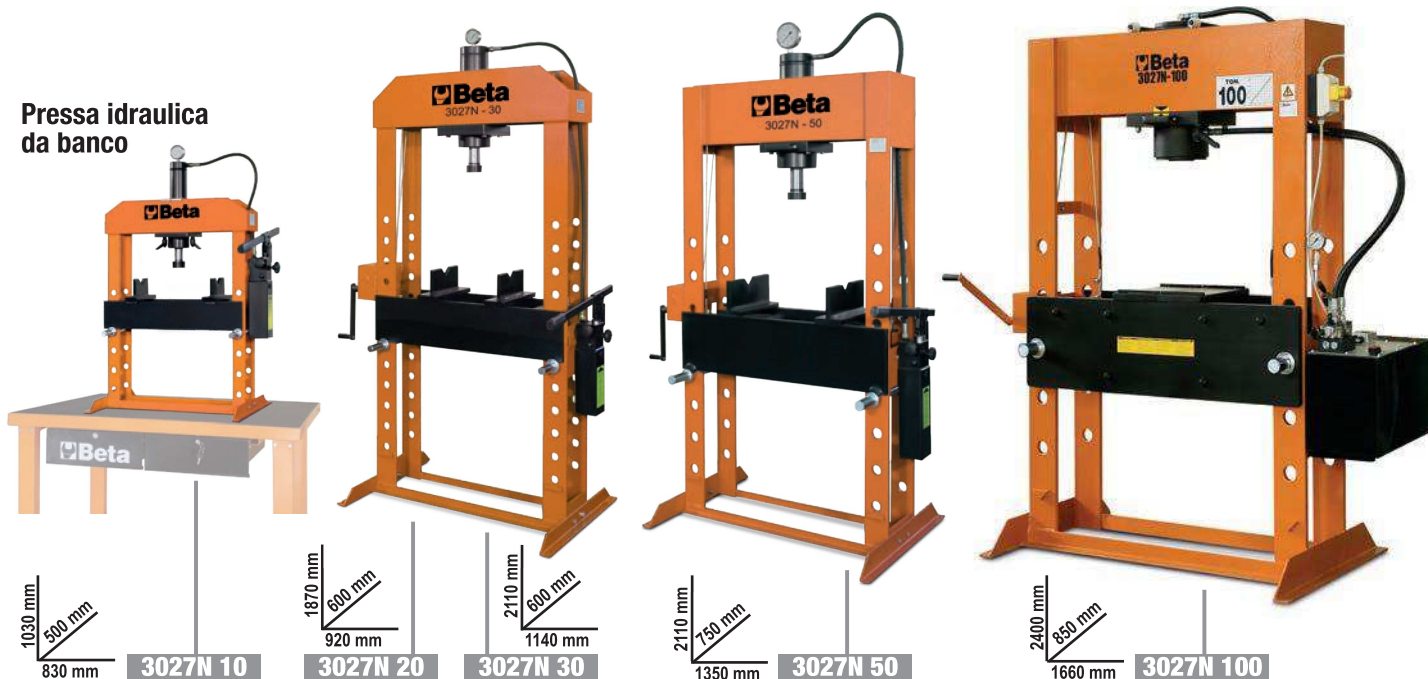

	kg		€
<b>3027N 10</b>	100	030270101	<del>€ 2.185,00</del> <b>€ 1.029,00</b>
<b>3027N 20</b>	130	030270102	<del>€ 2.918,00</del> <b>€ 1.339,00</b>
<b>3027N 30</b>	230	030270103	<del>€ 5.188,00</del> <b>€ 2.369,00</b>
<b>3027N 50</b>	350	030270105	<del>€ 7.118,00</del> <b>€ 3.599,00</b>
<b>3027N 100</b>	1100	030270110	<del>€ 21.928,00</del> <b>€ 10.290,00</b>

	3027N 10	3027N 20	3027N 30	3027N 50	3027N 100
Capacità massima	10 t	20 t	30 t	50 t	100 t
Pompa manuale a 2 velocità	✓	✓	✓	✓	X
Pistone mobile	✓	✓	✓	✓	✓
Sicurezza idraulica in caso di sovraccarico	✓	✓	✓	✓	✓
Manometro	✓	✓	✓	✓	✓
Serie prismi a V inclusi	✓	✓	✓	✓	✓
Argano	X	X	✓	✓	✓

### 3025N 1,0

Gru idraulica pieghevole con pompa a doppio effetto

- Portata massima: 1 t
- 4 posizioni di carico: 300-600-800-1000 kg
- Con valvola limitatrice di carico e stelo cromato
- Velocità di discesa controllata
- Ruote in nylon
- Altezza massima: 2420 mm

99 kg 030250110



~~€ 2.385,00~~  
**€ 1.190,00**



### 3025N/PF

Pinza movimentazione fusti

Grazie alla nuova struttura, riprogettata e migliorata, questa pinza è in grado di sollevare e movimentare fusti olio di grandi dimensioni

030250111

~~€ 521,00~~  
**€ 298,00**



**Brache per sollevamento**

- Codice seriale
- Protezione etichetta dati
- Carico di lavoro stampato sul nastro



**8150**

**1 T VIOLA**  
nastro piatto a due strati,  
asole rinforzate,  
poliestere alta tenacità (PES)  
EN 1492-1

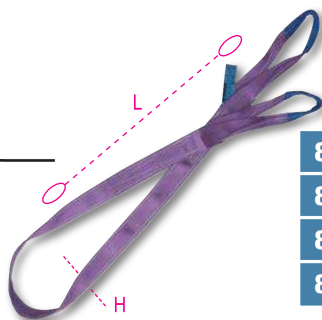

	L m	H mm		€
<b>8150 1-T1</b>	1	30	081500010	<del>€ 6,00</del> <b>€ 4,00</b>
<b>8150 2-T1</b>	2	30	081500020	<del>€ 8,50</del> <b>€ 5,00</b>
<b>8150 3-T1</b>	3	30	081500030	<del>€ 10,80</del> <b>€ 7,00</b>
<b>8150 4-T1</b>	4	30	081500040	<del>€ 13,90</del> <b>€ 9,00</b>

**8153**

**2 T VERDE**  
nastro piatto a due strati,  
asole rinforzate,  
poliestere alta tenacità (PES)  
EN 1492-1

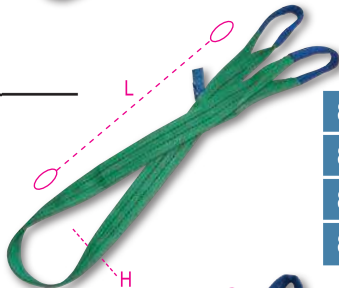

	L m	H mm		€
<b>8153 1-T2</b>	1	60	081530010	<del>€ 9,45</del> <b>€ 6,00</b>
<b>8153 2-T2</b>	2	60	081530020	<del>€ 14,60</del> <b>€ 9,00</b>
<b>8153 3-T2</b>	3	60	081530030	<del>€ 19,90</del> <b>€ 12,00</b>
<b>8153 4-T2</b>	4	60	081530040	<del>€ 24,50</del> <b>€ 15,00</b>

**8156**

**3 T GIALLO**  
nastro piatto a due strati,  
asole rinforzate,  
poliestere alta tenacità (PES)  
EN 1492-1

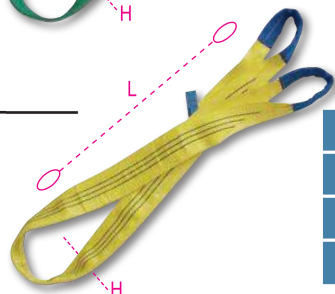

	L m	H mm		€
<b>8156 2-T3</b>	2	90	081560020	<del>€ 21,90</del> <b>€ 13,00</b>
<b>8156 3-T3</b>	3	90	081560030	<del>€ 30,50</del> <b>€ 19,00</b>
<b>8156 4-T3</b>	4	90	081560040	<del>€ 37,50</del> <b>€ 23,00</b>
<b>8156 6-T3</b>	6	90	081560060	<del>€ 53,00</del> <b>€ 32,00</b>

**8181 6/B4**

Borse set 4 cricchetti 8181 6 m  
nastro in poliestere  
ad alta tenacità (PES)  
gancio uncino



L m	LC kg
6	1000



EN 12195-2

081810916

~~€ 74,50~~  
**€ 40,00**

**8182 8,5/B2**

Borse set 2 cricchetti 8182 8,5 m  
nastro in poliestere  
ad alta tenacità (PES)  
gancio uncino



L m	LC kg
8,5	2000



EN 12195-2

081821885

~~€ 66,00~~  
**€ 35,00**

**8190**

**Tendicatena di ancoraggio a cricchetto  
con due ganci per catene di ancoraggio 8190B  
Grado 8**

EN12195/3



- Consentono la messa in sicurezza di carichi pesanti, mediante il tensionamento di catene in acciaio.
- Sono idonei per carichi con superfici irregolari e rischio di taglio.
- Consentono un numero inferiore di elementi di fissaggio rispetto ai nastri in poliestere.
- Elementi portanti a norma EN1677 (Grado 8)
- Coefficiente di sicurezza: 2
- Codice lotto
- Rapporto di Prova tipo 2.2 UNI EN10204
- Certificato di Controllo tipo 3.1 UNI EN10204

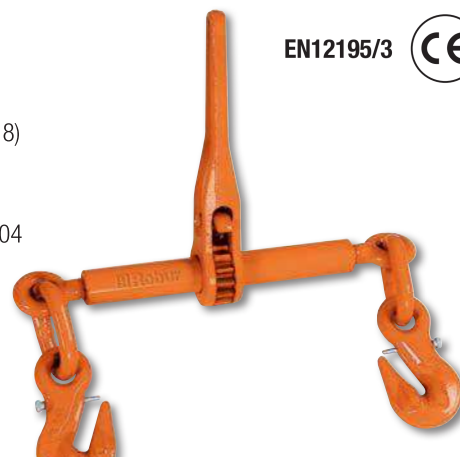

**NEW**

		Ø mm	LC daN		LC daN		€
<b>8190 8</b>		8	4000	X	X	081900008	<del>€ 55,00</del> <b>€ 30,00</b>
<b>8190 10</b>		10	6300			081900010	<del>€ 83,00</del> <b>€ 45,00</b>

# PENDENTI DI CATENA PER SOLLEVAMENTO



- Coefficiente di sicurezza: 4
- Piastrina di identificazione seriale

- Dichiarazione di Conformità
- Specifica Prodotto

## 2 BRACCI CON ACCORCIATORI



WLL ton	L m	Ø	Grado	Gancio CLEVIS	Gancio CLEVIS €	Gancio SELF-LOCK	Gancio SELF-LOCK €
1,6	1	6	G8	080970001	<del>€ 157,50</del> € 75,00	080970201	<del>€ 194,00</del> € 93,00
1,6	2	6	G8	080970002	<del>€ 188,00</del> € 89,00	080970202	<del>€ 224,50</del> € 107,00
1,6	3	6	G8	080970003	<del>€ 233,50</del> € 111,00	080970203	<del>€ 271,00</del> € 130,00
1,6	4	6	G8	080970004	<del>€ 277,00</del> € 132,00	080970204	<del>€ 322,00</del> € 154,00
<b>NEW</b> 2	1	6	G10	080971001	<del>€ 189,00</del> € 98,00	080971201	<del>€ 233,00</del> € 121,00
<b>NEW</b> 2	2	6	G10	080971002	<del>€ 225,50</del> € 117,00	080971202	<del>€ 269,00</del> € 140,00
<b>NEW</b> 2	3	6	G10	080971003	<del>€ 280,00</del> € 146,00	080971203	<del>€ 325,00</del> € 169,00
<b>NEW</b> 2	4	6	G10	080971004	<del>€ 332,00</del> € 173,00	080971204	<del>€ 386,00</del> € 201,00
<b>NEW</b> 3,5	1	8	G10	080971041	<del>€ 245,50</del> € 128,00	080971241	<del>€ 303,00</del> € 158,00
<b>NEW</b> 3,5	2	8	G10	080971042	<del>€ 317,00</del> € 165,00	080971242	<del>€ 374,00</del> € 194,00
<b>NEW</b> 3,5	3	8	G10	080971043	<del>€ 399,00</del> € 207,00	080971243	<del>€ 467,00</del> € 238,00
<b>NEW</b> 3,5	4	8	G10	080971044	<del>€ 469,00</del> € 244,00	080971244	<del>€ 527,00</del> € 274,00
4,25	1	10	G8	080970051	<del>€ 315,00</del> € 150,00	080970251	<del>€ 384,00</del> € 184,00
4,25	2	10	G8	080970052	<del>€ 401,00</del> € 192,00	080970252	<del>€ 470,00</del> € 226,00
4,25	3	10	G8	080970053	<del>€ 484,00</del> € 232,00	080970253	<del>€ 553,00</del> € 265,00
4,25	4	10	G8	080970054	<del>€ 570,00</del> € 279,00	080970254	<del>€ 639,00</del> € 319,00

Le immagini sono indicative: fare riferimento ai dati in tabella

## 4 BRACCI CON ACCORCIATORI



WLL ton	L m	Ø	Grado	Gancio CLEVIS	Gancio CLEVIS €	Gancio SELF-LOCK	Gancio SELF-LOCK €
2,36	1	6	G8	080980001	<del>€ 324,00</del> € 156,00	080980201	<del>€ 396,00</del> € 191,00
2,36	2	6	G8	080980002	<del>€ 398,00</del> € 191,00	080980202	<del>€ 487,00</del> € 234,00
2,36	3	6	G8	080980003	<del>€ 472,00</del> € 227,00	080980203	<del>€ 545,00</del> € 262,00
2,36	4	6	G8	080980004	<del>€ 548,00</del> € 263,00	080980204	<del>€ 637,00</del> € 306,00
<b>NEW</b> 3	1	6	G10	080981001	<del>€ 389,00</del> € 202,00	080981201	<del>€ 477,00</del> € 248,00
<b>NEW</b> 3	2	6	G10	080981002	<del>€ 477,00</del> € 248,00	080981202	<del>€ 584,00</del> € 303,00
<b>NEW</b> 3	3	6	G10	080981003	<del>€ 566,00</del> € 294,00	080981203	<del>€ 654,00</del> € 340,00
<b>NEW</b> 3	4	6	G10	080981004	<del>€ 657,00</del> € 341,00	080981204	<del>€ 764,00</del> € 397,00
4,25	1	8	G8	080980041	<del>€ 424,00</del> € 204,00	080980241	<del>€ 543,00</del> € 261,00
4,25	2	8	G8	080980042	<del>€ 537,00</del> € 258,00	080980242	<del>€ 633,00</del> € 304,00
4,25	3	8	G8	080980043	<del>€ 653,00</del> € 313,00	080980243	<del>€ 749,00</del> € 360,00
4,25	4	8	G8	080980044	<del>€ 799,00</del> € 384,00	080980244	<del>€ 895,00</del> € 430,00
<b>NEW</b> 5,3	1	8	G10	080981041	<del>€ 509,00</del> € 265,00	080981241	<del>€ 651,00</del> € 339,00
<b>NEW</b> 5,3	2	8	G10	080981042	<del>€ 644,00</del> € 335,00	080981242	<del>€ 759,00</del> € 395,00
<b>NEW</b> 5,3	3	8	G10	080981043	<del>€ 783,00</del> € 407,00	080981243	<del>€ 899,00</del> € 468,00
<b>NEW</b> 5,3	4	8	G10	080981044	<del>€ 959,00</del> € 499,00	080981244	<del>€ 1.074,00</del> € 559,00

Le immagini sono indicative: fare riferimento ai dati in tabella

**8143**

**Paranchi manuali a catena**

Modello professionale, realizzato con materiali di alta qualità e progettato per sollevare carichi pesanti rapidamente e in sicurezza.



**CERTIFICAZIONE TUV EN 13157**

	WLL t	L m	kg		€
<b>8143 0,5T</b>	0,5	3	9,2	081430005	<del>€ 211,50</del> <b>€ 127,00</b>
<b>8143 1T</b>	1	3	11,7	081430010	<del>€ 249,50</del> <b>€ 149,00</b>
<b>8143 2T</b>	2	3	19,5	081430020	<del>€ 362,00</del> <b>€ 217,00</b>
<b>8143 3T</b>	3	3	19,5	081430030	<del>€ 467,00</del> <b>€ 269,00</b>

**8146**

**Paranchi manuali a leva con sistema di protezione da sovraccarico**

- Modello professionale, facile da installare e utilizzare
- Freno automatico a doppio salterello per garantire le migliori condizioni di sicurezza
- Gancio girevole con sicura

Certificati disponibili:  
 • Certificato fabbricante  
 • Dichiarazione di conformità CE  
 • Rapporto di prova tipo 2:2 EN 10204



**MODELLO LEGGERO E PORTATILE**

**CERTIFICAZIONE TUV EN 13157**

	WLL t	L m	kg		€
<b>8146 0,75T</b>	0,75	1,5	6,7	081460008	<del>€ 258,00</del> <b>€ 154,00</b>
<b>8146 1,5T</b>	1,50	1,5	11,2	081460015	<del>€ 367,00</del> <b>€ 220,00</b>

**8146C**

**Paranchi manuali a leva compatti**

	WLL t	L m	kg		€
<b>8146C 0,25T</b>	0,25	1,5	2,5	081460002	<del>€ 237,50</del> <b>€ 142,00</b>



**8145VX**

**Paranchi manuali a catena compatti**

Modello professionale con corpo in alluminio, leggero, ergonomico e di piccole dimensioni. Ideale per sollevamenti verticali in spazi ristretti.

- Dati tecnici:
- Coefficiente di sicurezza: 4
  - Piastra di identificazione seriale

Certificati disponibili:  
 • Certificato del Fabbricante  
 • Dichiarazione di Conformità CE  
 • Rapporto di Prova tipo 2.2 UNI EN10204  
 • Specifica Prodotto



**CERTIFICAZIONE TUV EN 13157**

	WLL kg	L m	kg		€
<b>8145VX 125</b>	125	3	2,5	081450001	<del>€ 295,00</del> <b>€ 155,00</b>
<b>8145VX 500</b>	500	3	4,5	081450005	<del>€ 345,00</del> <b>€ 185,00</b>



**NEW**

**8149B**

**Borse raccoglicatena paranchi in tessuto colore nero**

Le asole della sacca si ancorano al paranco tramite grilli in acciaio inox, offrendo una connessione stabile e resistente.

	8143 t	8143 L m
8149B 12x35	0,5	3/6
	1	3/6
	1,5	3/6
	2	3/6
8149B 14,5x45	3	3
	3	6
	5	3/6
	10	3



	FxC mm		€
<b>8149B 12X35</b>	120x350	081490612	<del>€ 35,00</del> <b>€ 18,00</b>
<b>8149B 14,5X45</b>	145x450	081490614	<del>€ 42,00</del> <b>€ 22,00</b>

**NEW**

## 8147S

### Carrelli di traslazione a spinta per paranchi manuali

Ideali per travi strutturali come ad esempio travi INP, IPB, IPE, HEA, HEB

Dati tecnici:

- Coefficiente di sicurezza: 4
- Piastra di identificazione seriale

Certificati disponibili:

- Certificato del Fabbricante
- Dichiarazione di Conformità CE
- Rapporto di Prova tipo 2.2 UNI EN10204
- Specifica Prodotto

	WLL t	L Min+Max mm	ø F mm		€
<b>8147S 0,5T</b>	0,5	50+220	25	081470005	<del>€ 178,00</del> <b>€ 102,00</b>
<b>8147S 1T</b>	1	58+220	30	081470010	<del>€ 217,50</del> <b>€ 131,00</b>
<b>8147S 2T</b>	2	66+220	40	081470020	<del>€ 277,00</del> <b>€ 166,00</b>



EN 13157

## 8148

### Argano manuale a fune passante, corpo in lega di alluminio completo di leva di azionamento, fune e gancio



EN 13155



L 20/30 m

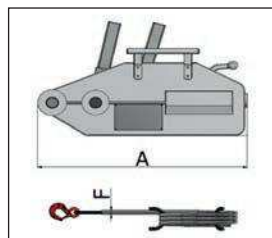

Dati tecnici:

- Coefficiente di sicurezza 4:1
- Piastra di identificazione seriale

Certificati disponibili:

- Certificato del Fabbricante
- Dichiarazione di Conformità CE
- Rapporto di Prova tipo 2.2 UNI EN10204

	WLL t	L m	A mm	ø f mm		€
<b>8148 0,8X20M</b>	0,8	20	426	8,3	081480008	<del>€ 379,00</del> <b>€ 225,00</b>
<b>8148 1,6X20M</b>	1,6	20	545	11	081480016	<del>€ 594,00</del> <b>€ 350,00</b>
<b>8148 3,2X20M</b>	3,2	20	660	16	081480032	<del>€ 978,00</del> <b>€ 585,00</b>

## 8135

### Pinze di sollevamento per superfici piane con durezza max 30HRC/300HB con anello di sospensione snodato

Dati tecnici:

- Coefficiente di sicurezza: 3
- Piastra di identificazione seriale

Certificati disponibili:

- Certificato del Fabbricante
- Dichiarazione di Conformità CE
- Rapporto di Prova tipo 2.2 UNI EN10204

Non sollevare mai un carico di peso inferiore al 10% della portata massima nominale



EN 13155

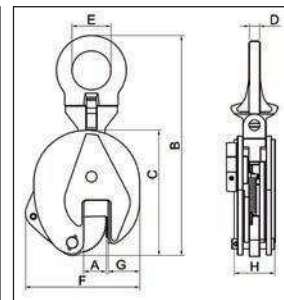

	max WLL t	A mm		kg		€
<b>8135 0,75T</b>	0,75	0-15	2	081350005	<del>€ 131,00</del> <b>€ 78,00</b>	
<b>8135 1,0T</b>	1,0	0-20	5	081350010	<del>€ 177,00</del> <b>€ 107,00</b>	
<b>8135 2,0T</b>	2,0	0-25	8	081350020	<del>€ 263,00</del> <b>€ 157,00</b>	
<b>8135 3,0T</b>	3,0	0-30	15	081350032	<del>€ 446,00</del> <b>€ 267,00</b>	
<b>8135 5,0T</b>	5,0	0-50	23	081350050	<del>€ 627,00</del> <b>€ 376,00</b>	

max WLL (t)	Dimensioni mm						
	B	C	D	E	F	G	H
0,75	205	125	10	27	105	35	40
1,0	290	170	12	48	145	45	56
2,0	375	205	17	67	175	56	56
3,0	425	237	20	75	215	60	78
5,0	490	262	20	80	232	65	80

**1927P**

2 kg 019270008

**1 1/2" Avvitatore reversibile in materiale composito**



€ 464,00  
**€ 199,00**

- Meccanismo impulsivo doppio martello
- Leggero e bilanciato per un facile utilizzo
- Comando d'inversione a leva
- Tre differenti livelli di potenza in avvitamento
- Scarico dell'aria attraverso l'impugnatura
- Impugnatura antivibrazioni
- Utilizzare solo con bussole macchina

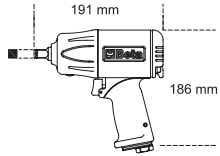

**SUPER POTENTE 1750 Nm**

Velocità libera	giri/min	7.500
Massa battente		Doppio martello
Coppia massima	Nm	<b>1750</b>
Capacità vite/dado	Cl 8.8	M24 ● 36 mm
Capacità vite/dado	Cl 12.9	M20 ● 30 mm
Attacco aria	GAS	1/4"
Pressione di utilizzo	bar	6,2
Ø interno tubo aria	mm	10
Consumo aria medio	l/min	290

**1927P/K3**

4 kg 019270118

**Avvitatore reversibile in materiale composito fornito con 3 bussole macchina, in valigetta di plastica**

€ 686,00  
**€ 219,00**

720LC 17-19-21 mm

1 1/2"



350x305x86 mm

**1927E**

2,4 kg 019270005

**1 1/2" Avvitatore reversibile in materiale composito**



€ 144,00  
**€ 80,00**

- Meccanismo impulsivo doppio martello
- Comando d'inversione tramite manopola
- Tre differenti livelli di potenza in avvitamento
- Scarico dell'aria attraverso l'impugnatura
- Impugnatura antivibrazioni
- Utilizzare solo con bussole macchina

Velocità libera	giri/min	7.000
Massa battente		Doppio martello
Coppia massima	Nm	<b>750</b>
Capacità vite/dado	Cl 8.8	M22 ● 36 mm
Capacità vite/dado	Cl 12.9	M18 ● 30 mm
Attacco aria	GAS	1/4"
Pressione di utilizzo	bar	6,2
Ø interno tubo aria	mm	10
Consumo aria medio	l/min	140

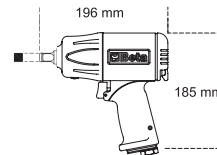

SCOPRI DI PIÙ



**1927C**

2,4 kg 019270006

**1 1/2" Avvitatore reversibile in materiale composito**



€ 242,00  
**€ 132,00**

- Meccanismo impulsivo doppio martello
- Leggero e bilanciato per un facile utilizzo
- Comando d'inversione a leva
- Tre differenti livelli di potenza in avvitamento
- Scarico dell'aria attraverso l'impugnatura
- Utilizzare solo con bussole macchina

Velocità libera	giri/min	9.000
Massa battente		Doppio martello
Coppia massima	Nm	<b>950</b>
Capacità vite/dado	Cl 8.8	M22 ● 34 mm
Capacità vite/dado	Cl 12.9	M18 ● 27 mm
Attacco aria	GAS	1/4"
Pressione di utilizzo	bar	6,2
Ø interno tubo aria	mm	10
Consumo aria medio	l/min	140

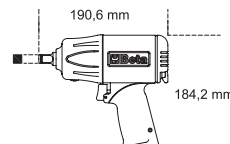

SCOPRI DI PIÙ



OIL  
LESS

# IL RIVOLUZIONARIO AVVITATORE CHE NON DEVE ESSERE LUBRIFICATO

SCOPRI DI PIÙ



L'avvitatore 1927OLS, studiato, progettato e INGEGNERIZZATO INTERAMENTE DA BETA UTENSILI, è caratterizzato dal SISTEMA OIL-LESS, un'innovazione assoluta che consente all'avvitatore di funzionare perfettamente senza bisogno di lubrificarlo periodicamente con olio, assicurando una maggiore durata nel tempo e prestazioni elevate.

ENGINEERED by  
**Beta**



L'assemblaggio curato nei minimi particolari, l'allineamento micrometrico dei componenti interni e l'utilizzo di materiali innovativi di elevata qualità garantiscono un minor numero di guasti per un utilizzo a vita senza la necessità di lubrificazione.



**1927OLS**

2,5 kg

019270010

**12"** Avvitatore reversibile OIL-LESS con corpo in lega di alluminio

~~€ 752,00~~  
**€ 399,00**

- Meccanismo impulsivo doppio martello
- Comando d'inversione a leva
- Utilizzare solo con bussole macchina

**PATENT PENDING**

L'avvitatore OIL-LESS si contraddistingue per una TRASMISSIONE DI COPPIA ELEVATA PARI A 1750 Nm che lo rende ideale per qualsiasi applicazione.



- 1** Bilanciato e potente con una durata ineguagliabile
- 2** Tre differenti livelli di potenza in avvitamento
- 3** Impugnatura antivibrazioni
- 4** Scarico dell'aria attraverso l'impugnatura

**4 VOLTE  
LA VITA UTILE DI UN  
AVVITATORE CLASSICO**



**4x  
CICLI  
DI VITA**

Velocità libera	8.000 giri/min
Coppia massima	1.750 Nm
Capacità vite/dado	Cl 8.8 M24 ● 36 mm
Capacità vite/dado	Cl 12.9 M20 ● 30 mm
Attacco aria	1/4" GAS
Pressione di utilizzo	6,2 bar
Ø interno tubo aria	10 mm
Consumo aria medio	198 l/min
Peso	2,5 kg

Queste caratteristiche fanno sì che l'avvitatore OIL-LESS si distingua per il rapporto costo/benefici, garantendo all'utilizzatore un risparmio nel lungo periodo.

1927XM

1,3 kg 019270030

12" Avvitatore reversibile compatto

- Meccanismo impulsivo singolo martello
- Incredibilmente compatto e potente
- Comando d'inversione a pulsante azionabile con una sola mano
- Tre differenti livelli di potenza in avvitamento
- Scarico dell'aria attraverso l'impugnatura
- Gancio per bilanciatore
- Utilizzare solo con bussole macchina



€ 288,00  
€ 152,00

**SUPER COMPATTO**

Velocità libera	giri/min	10.000
Massa battente		Singolo martello
Coppia massima	Nm	770
Capacità vite/dado	Cl 8.8	M22 ● 34 mm
Capacità vite/dado	Cl 12.9	M18 ● 27 mm
Attacco aria	GAS	1/4"
Pressione di utilizzo	bar	6,2
Ø interno tubo aria	mm	10
Consumo aria medio	l/min	122

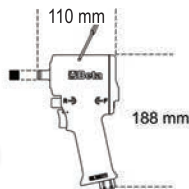

1927XM/K5

2,8 kg 019270129

Avvitatore reversibile compatto fornito con 5 bussole macchina, in valigetta di plastica

€ 355,00  
€ 183,00



720 17-19-21-22-24 mm



307x206x86 mm

1928XM

2,9 kg 019280030

3/4" Avvitatore reversibile compatto

- Meccanismo impulsivo doppio martello
- Incredibilmente compatto e potente
- Comando d'inversione a leva azionabile con una sola mano
- Tre differenti livelli di potenza in avvitamento
- Scarico dell'aria attraverso l'impugnatura
- Utilizzare solo con bussole macchina



€ 616,00  
€ 349,00



**1600 Nm SUPER COMPATTO E POTENTE**



Velocità libera	giri/min	4.800
Massa battente		Doppio martello
Coppia massima	Nm	1600
Capacità vite/dado	Cl 8.8	M27 ● 41 mm
Capacità vite/dado	Cl 12.9	M24 ● 36 mm
Attacco aria	GAS	3/8"
Pressione di utilizzo	bar	6,2
Ø interno tubo aria	mm	10
Consumo aria medio	l/min	175

SCOPRI DI PIÙ

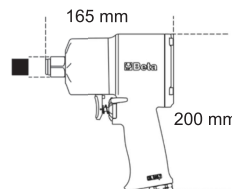

1928P

3,7 kg 019280006

3/4" Avvitatore reversibile in materiale composito

- Meccanismo impulsivo doppio martello
- Leggero e bilanciato per un facile utilizzo
- Comando d'inversione a leva
- Tre differenti livelli di potenza in avvitamento
- Scarico dell'aria attraverso l'impugnatura
- Impugnatura antivibrazioni
- Utilizzare solo con bussole macchina



€ 1.225,00  
€ 565,00



**2100 Nm AVVITATORE SUPER-POTENTE REVERSIBILE IN MATERIALE COMPOSITO**

Velocità libera	giri/min	5.000
Massa battente		Doppio martello
Coppia massima	Nm	2100
Capacità vite/dado	Cl 8.8	M30 ● 46 mm
Capacità vite/dado	Cl 12.9	M27 ● 41 mm
Attacco aria	GAS	3/8"
Pressione di utilizzo	bar	6,2
Ø interno tubo aria	mm	10

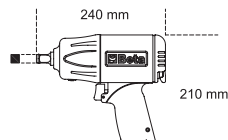

1930PA

9,6 kg 019300032

1" Avvitatore reversibile

- Meccanismo impulsivo doppio martello
- Dotato di maniglia ausiliaria
- Comando d'inversione a leva
- Tre differenti livelli di potenza in avvitamento e svitamento
- Scarico dell'aria attraverso l'impugnatura
- Utilizzare solo con bussole macchina

€ 1.330,00  
€ 720,00

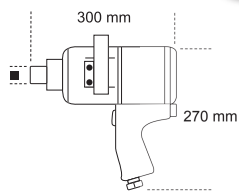

Velocità libera	giri/min	3.500
Massa battente		Doppio martello
Coppia massima	Nm	2445
Capacità vite/dado	Cl 8.8	M36●55 mm
Capacità vite/dado	Cl 12.9	M30●46 mm
Attacco aria	GAS	1/2"
Pressione di utilizzo	bar	6,2
Ø interno tubo aria	mm	13
Consumo aria medio	l/min	350

1922P3

1,5 kg 019220013

1/2" Cricchetto reversibili a massa battente

- Meccanismo impulsivo tipo "rocking dog" con doppio martello
- Facilità di serraggio: il sistema a massa battente elimina la torsione del polso a fine avvitatura e riduce i tempi operativi
- Compatto e potente: la coppia massima raggiungibile è notevolmente superiore rispetto a quella ottenibile con un cricchetto tradizionale
- Impugnatura ergonomica in gomma
- Utilizzare solo con bussole macchina

€ 450,00  
€ 256,00



292 mm

136 Nm COPPIE ELEVATE SENZA CONTRACCOLPI SUL POLSO

Velocità libera	giri/min	600
Coppia massima	Nm	136
Capacità vite/dado	Cl 8.8	M12●18 mm
Capacità vite/dado	Cl 12.9	M10●16 mm
Attacco aria	GAS	1/4"
Pressione di utilizzo	bar	6,2
Ø interno tubo aria	mm	10
Consumo aria medio	l/min	113

720/C24

007200904

12" 24 chiavi a bussola Macchina



€ 435,00  
€ 215,00

420x185x60 mm



720	10-12-13-14-15-16-17-18 19-21-22-24-27-30-32 mm
720L	13-17-19-21-22-24 mm
720LC	17-19-21 mm

720LC/C3

007200653

12" 3 chiavi a bussola Macchina per dadi ruote con inserti polimerici colorati



€ 41,50  
€ 24,00

17-19-21 mm



720ME/C8

007200525

12" 8 chiavi a bussola Macchina maschio esagonale



€ 159,50  
€ 92,00

5-6-8-10-12  
14-17-19 mm



270x120x45 mm



720/C12

007200912

12" 12 chiavi a bussola Macchina



€ 203,00  
€ 112,00

10-11-12-13-14-17-19  
22-24-27-30-32 mm



**1933**

👤 380 g 📄 019330001

**Smerigliatrice assiale**

- Fornita con pinza di Ø 3 e 6 mm

€ 151,50  
**€ 85,00**



Velocità libera	giri/min	25.000
Capacità pinza	mm	3-6
Potenza	kW	0,20
Attacco aria	GAS	1/4"
Pressione di utilizzo	bar	6,2
Ø interno tubo aria	mm	10
Consumo aria medio	l/min	230

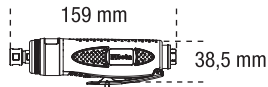

**1933IH**

👤 800 g 📄 019330006

**Smerigliatrice assiale alta potenza**

- Fornita con pinza di Ø 3 e 6 mm

€ 230,50  
**€ 133,00**



Velocità libera	giri/min	20.000
Capacità pinza	mm	3-6
Potenza	kW	0,75
Attacco aria	GAS	1/4"
Pressione di utilizzo	bar	6,2
Ø interno tubo aria	mm	10
Consumo aria medio	l/min	370

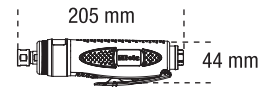

**1933AN90-H**

👤 1,1 kg 📄 019330021

**Smerigliatrice angolare alta potenza**

- Fornita con pinza di Ø 3 e 6 mm

€ 434,00  
**€ 248,00**



Velocità libera	giri/min	15.000
Capacità pinza	mm	3-6
Potenza	kW	0,75
Attacco aria	GAS	1/4"
Pressione di utilizzo	bar	6,2
Ø interno tubo aria	mm	10
Consumo aria medio	l/min	370

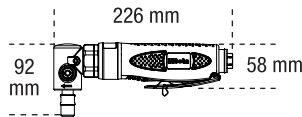

**1933L**

👤 670 g 📄 019330015

**Smerigliatrice assiale con albero prolungato**

- Fornita con pinza di Ø 3 e 6 mm

€ 193,50  
**€ 108,00**



Velocità libera	giri/min	25.000
Capacità pinza	mm	3-6
Potenza	kW	0,20
Attacco aria	GAS	1/4"
Pressione di utilizzo	bar	6,2
Ø interno tubo aria	mm	10
Consumo aria medio	l/min	370

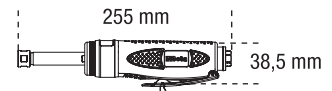

**1936**

**Smerigliatrice angolare**

- Estremamente compatta e maneggevole
- Dotata di "air governor" per il controllo automatico del massimo della velocità
- Dotata di maniglia ausiliaria con possibilità dx/sx
- Bloccaggio dell'albero mediante il pulsante "spindle lock"
- Dotata di accessorio per il cambio rapido dei dischi
- La cuffia di protezione può essere regolata velocemente in 9 diverse posizioni mediante sgancio rapido
- Scarico dell'aria posteriore

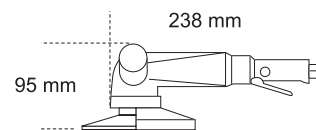

	📄	👤 kg	€
<b>1936/4A</b>	019360024	1,8	€ 469,00 <b>€ 263,00</b>
<b>1936/5A</b>	019360025	1,9	€ 469,00 <b>€ 263,00</b>

		1936/4A	1936/5A
Velocità libera	giri/min	11.000	10.000
Dimensione mola	mm	115	125
Potenza	kW	0,66	0,66
Filettatura albero	M	14	14
Attacco aria	GAS	1/4"	1/4"
Pressione di utilizzo	bar	6,2	6,2
Ø interno tubo aria	mm	10	10
Consumo aria medio	l/min	280	280

## 1946

### Rivettatrice

- Per impiego con rivetti in acciaio, acciaio inox, alluminio e rame da 2,4 - 3,2 - 4,0 - 4,8 mm

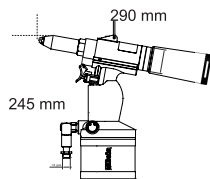

Materiale/rivetto	2,4	3,2	4	4,8
Rame	✓	✓	✓	✓
Alluminio	✓	✓	✓	✓
Acciaio	✓	✓	✓	
Acciaio Inox	✓	✓	✓	

Potenza di trazione	8.000 N
Lunghezza della corsa	14 mm
Capacità massima rivetti	Ø alluminio 4,8 mm
Attacco aria	1/4" GAS
Pressione di utilizzo	6,2 bar
Ø interno tubo aria	6 mm
Consumo aria	1,2 l/ciclo



1,5 kg

019460001



€ 212,00  
€ 122,00



## 1946C 7,8

### Rivettatrice

- Per impiego con rivetti in acciaio, acciaio inox, alluminio e rame, da 4,8 - 5,6 - 6,4 - 7,8 mm
- Becco conico a punta
- Potente e maneggevole, con impugnatura in composito
- Completa di serbatoio portasteli e siringa per la lubrificazione
- Mantenere aperto al massimo il rubinetto di aspirazione (particolare 58)

Materiale/rivetto	4,8	5,6	6,4	7,8
Rame	✓	✓	✓	✓
Alluminio	✓	✓	✓	✓
Acciaio	✓	✓	✓	✓
Acciaio Inox	✓	✓	✓	✓

Potenza di trazione	16.900 N
Lunghezza della corsa	22,5 mm
Capacità massima rivetti	Ø alluminio 7,8 mm
Attacco aria	1/4" GAS
Pressione di utilizzo	6,2 bar
Ø interno tubo aria	10 mm
Consumo aria	4,9 l/ciclo



1,8 kg

019460008



€ 1.042,00  
€ 515,00

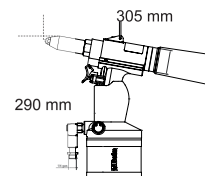

## 1949F2

### Pistola di soffiaggio progressiva

- In composito di materiale plastico ad alta resistenza, antiurto, antigraffio e termicamente isolato
- La speciale valvola e la sensibilità della leva consentono la progressiva apertura del circuito, ottimizzando il flusso dell'aria
- Puntale dotato di cono di sicurezza in plastica per una movimentazione sicura in fase di non utilizzo



019490028

€ 18,50  
€ 10,50

Inserto ottone filettato	GAS	1/4"
Pressione di utilizzo	bar	4-8
Pressione massima di utilizzo	bar	12

## 1948

### Penna per incisioni

- Consente marcature su materiali quali l'acciaio, l'acciaio inossidabile, l'alluminio, il vetro, la pietra e la ceramica



019480001

€ 342,00  
€ 169,00

Colpi al minuto	3.500 + 3.800
Durezza massima	60 HRC
Attacco aria	1/4" GAS
Pressione di utilizzo	6,2 bar
Consumo aria medio	50 l/min

# RENEGADE

## LA LINEA DI CALZATURE ANTINFORTUNISTICHE

SCOPRI DI PIÙ



### Progettata per chi non scende a compromessi tra sicurezza e stile

La linea, composta da 6 modelli in colori e materiali unici, è perfetta per chi vuole distinguersi in ogni ambiente di lavoro. Con un design ispirato alle scarpe sportive di ultima generazione, ammortizzazione superiore e supporto eccezionale, Renegade garantisce comfort per tutta la giornata.

**GRINTOSA E FUORI DAGLI SCHEMI,**  
è la scelta ideale per il professionista moderno.

- 1 DESIGN INNOVATIVO**
- 2 TRASPIRANTE E RESISTENTE**
- 3 BATTISTRADA IN GOMMA NITRILICA**  
ad alta resistenza.
- 4 CALZATA AMPIA**  
L'ampia calzata 11 assicura una camminata fluida e confortevole, evitando costrizioni del piede.
- 5 ALLACCIATURA RAPIDA**  
Il modello 7340VA è la prima scarpa Beta dotata di sistema di allacciatura rapido
- 6 METAL FREE**  
Lamina e puntale antiperforazione in fibra composita



**RENEGADE COMBINA PROTEZIONE CON UN'ESTETICA GRINTOSA E MODERNA**



### 7340VA

495 g

Scarpe **RENEGADE** in tessuto mesh ad alta traspirazione con allacciatura rapida ATOP.

~~€ 179,50~~  
**€ 99,00**

S1PS FO SR HRO

Taglie disponibili: da 37 a 48

da 073400537 a 073400548

# RENEGADE



## 7340G

495 g

Scarpe RENEGADE in tessuto mesh ad alta traspirazione. Allacciatura tradizionale.

~~€ 146,00~~  
€ 83,00



S1PS FO SR HRO

Taglie disponibili: da 37 a 48  
da 073400637 a 073400648

## 7341V

495 g

Scarpe RENEGADE in tessuto intrecciato resistente e ad altissima traspirazione. Allacciatura tradizionale.

~~€ 153,50~~  
€ 85,00



S1PS FO SR HRO

Taglie disponibili: da 37 a 48  
da 073410537 a 073410548

## 7341Y

495 g

Scarpe RENEGADE in tessuto intrecciato resistente e ad altissima traspirazione. Allacciatura tradizionale.

~~€ 153,50~~  
€ 85,00



S1PS FO SR HRO

Taglie disponibili: da 37 a 48  
da 073410637 a 073410648

## 7342N

500 g

Scarpe RENEGADE in microfibra idrorepellente. Allacciatura tradizionale.

~~€ 163,00~~  
€ 93,00



S3S FO SR HRO

Taglie disponibili: da 37 a 48  
da 073420537 a 073420548



## 7343N

510 g

Scarpe RENEGADE alte in microfibra idrorepellente. Allacciatura tradizionale.

~~€ 177,50~~  
€ 99,00

S3S FO SR HRO

Taglie disponibili: da 37 a 48  
da 073430537 a 073430548

# FitEvolution

7 MODELLI DAL DESIGN UNICO, DISPONIBILI IN VARIE COLORAZIONI E MATERIALI PER SODDISFARE OGNI ESIGENZA.

SCOPRI DI PIÙ



**SISTEMA BREVETTATO BETA**  
**FIT4YOU**  
 CHE PERMETTE DI SCEGLIERE IL PROPRIO COMFORT



Questa tecnologia innovativa consente di personalizzare il livello di morbidezza e supporto della scarpa in base al peso, all'altezza e alle specifiche esigenze dell'utilizzatore.

Grazie ai **tre diversi inserti in ETPU forniti con la scarpa** - MORBIDO, INTERMEDIO o RIGIDO - è possibile adattare la calzatura perfettamente al comfort desiderato.

L'**ETPU** con le sue eccellenti proprietà ammortizzanti e di ritorno di energia **aiuta a ridurre l'affaticamento durante il lavoro.**



**TROVI TUTTI E 3 GLI INSERTI  
 IN OGNI CONFEZIONE DI SCARPE FITEVOLUTION.  
 PROVALI E SCEGLI IL MIGLIORE PER TE!**

Una calzatura personalizzata per affrontare ogni giornata lavorativa con stile, protezione e comfort imbattibili



- Sistema brevettato FIT 4 YOU, 3 Inserti in ETPU con 3 differenti densità per personalizzare la scarpa
  - Puntale in composito
- Lamina antiperforazione in fibra composita
  - Supporto di stabilità tallone
  - Allacciatura tradizionale
- Suola in poliuretano bidensità

**7272V**

550 g

Scarpe FitEvolution in tessuto intrecciato resistente e ad alta traspirazione

€ 155,50  
**€ 87,00**

S1 PS FO SR ESD

Taglie disponibili: da 37 a 48

da 072720137 a 072720148

# FitEvolution



## 7270Y

Scarpe FitEvolution  
in tessuto mesh ad alta traspirazione

550 g

~~€ 155,50~~  
€ 87,00



S1 PS FO SR ESD

Taglie disponibili: da 37 a 48  
da 072700137 a 072700148

## 7271V

Scarpe FitEvolution  
in pelle scamosciata traforata

550 g

~~€ 155,50~~  
€ 87,00



S1 PS FO SR ESD

Taglie disponibili: da 37 a 48  
da 072710137 a 072710148

## 7273G

Scarpe FitEvolution  
in nabuk idrorepellente

590 g

~~€ 159,50~~  
€ 89,00



S3 S FO SR ESD

Taglie disponibili: da 37 a 48  
da 072730137 a 072730148

## 7274G

Scarpe alte FitEvolution  
in nabuk idrorepellente

650 g

~~€ 165,00~~  
€ 93,00



S3 S FO SR ESD

Taglie disponibili: da 37 a 48  
da 072740237 a 072740248

## 7275N

Scarpe FitEvolution  
in microfibra idrorepellente

590 g

~~€ 159,50~~  
€ 89,00



S3 S FO SR ESD

Taglie disponibili: da 37 a 48  
da 072750237 a 072750248

## 7276N

Scarpe alte FitEvolution  
in microfibra idrorepellente

650 g

~~€ 165,00~~  
€ 93,00



S3 S FO SR ESD

Taglie disponibili: da 37 a 48  
da 072760237 a 072760248

**Beta**  
O-Gravity



- Suola in EVA con battistrada in gomma nitrilica ad alta resistenza
- Intersuola in eva

- Supporto di stabilità tallone
- Lamina antiperforazione in fibra composita
- Puntale in composito

**7352B**

450 g

Scarpe O-Gravity leggerissime, in tessuto mesh ad alta traspirazione

- Collare "slip on"

~~€ 138,50~~  
**€ 78,00**

EN ISO  
20345:2022  
+ A1:2024



**S1PL FO SR HRO**

Taglie disponibili: da 38 a 48  
da 073520138 a 073520148

**7352G**

450 g

Scarpe O-Gravity leggerissime, in tessuto mesh ad alta traspirazione

- Allacciatura tradizionale

~~€ 143,50~~  
**€ 81,00**

EN ISO  
20345  
2011



**S1P HRO SRC ESD**



Taglie disponibili: da 38 a 48  
da 073520338 a 073520348

**7354N**

460 g

Scarpe O-Gravity leggerissime in tessuto mesh idrorepellente

- Collare "slip on"

~~€ 143,00~~  
**€ 81,00**

EN ISO  
20345:2022  
+ A1:2024



**S3L FO SR HRO**

Taglie disponibili: da 38 a 48  
da 073540038 a 073540048

**7356G**

460 g

Scarpe O-Gravity leggerissime in microfibra idrorepellente

- Collare "slip on"

~~€ 147,50~~  
**€ 83,00**

EN ISO  
20345:2022  
+ A1:2024



**S3L FO SR HRO**

Taglie disponibili: da 38 a 48  
da 073560038 a 073560048

**7372B**

450 g

Scarpe O-Gravity leggerissime, in tessuto intrecciato resistente e ad altissima traspirazione

- Allacciatura tradizionale

~~€ 146,50~~  
**€ 82,00**

EN ISO  
20345  
2011



**S1P HRO SRC**



Taglie disponibili: da 38 a 46  
da 073720038 a 073720046

**7352LG**

390 g

Scarpe O-Gravity leggerissime, in tessuto mesh ad alta traspirazione

- Collare "slip on"

~~€ 143,00~~  
**€ 81,00**

EN ISO  
20345:2022  
+ A1:2024



**S1PL FO SR HRO**

Taglie disponibili: da 34 a 42  
da 073520234 a 073520242

ACTIVE



- Punta in composito
- Lamina antiperforazione in fibra composita

7320NA

550 g

Scarpe in microfibra idrorepellente con rinforzo antiabrasione nella zona del puntale e supporto di stabilità al tallone

~~€ 79,50~~  
€ 46,00

EN ISO 20345:2022 + A1:2024



S3L FO SR

Taglie disponibili: da 35 a 48  
da 073200535 a 073200548

7316NG

510 g

Scarpe in mesh ad alta traspirazione e pelle scamosciata con supporto di stabilità al tallone

~~€ 88,00~~  
€ 49,90

EN ISO 20345 2011



S1P SRC ESD



Taglie disponibili: da 35 a 48  
da 073160635 a 073160648

7321NA

570 g

Scarpe alte in microfibra idrorepellente con rapido sfilamento, rinforzo antiabrasione nella zona del puntale e supporto di stabilità al tallone

~~€ 82,00~~  
€ 48,00

EN ISO 20345:2022 + A1:2024



RAPIDO SFILAMENTO

S3L FO SR

Taglie disponibili: da 35 a 48  
da 073210535 a 073210548

7322SA

570 g

Scarpe in tessuto ad elevata resistenza all'abrasione con supporto di stabilità al tallone

~~€ 86,00~~  
€ 49,90

EN ISO 20345:2022 + A1:2024



S3 SRC

Taglie disponibili: da 35 a 48  
da 073220435 a 073220448

7317NA

550 g

Scarpe in pelle scamosciata traforata con supporto di stabilità al tallone

~~€ 75,50~~  
€ 44,00

EN ISO 20345:2022 + A1:2024



S1PL FO SR

Taglie disponibili: da 35 a 48  
da 073170135 a 073170148

FLEX



EN ISO 20345 2011



7214G

500 g

Scarpe in action nabuk idrorepellente con inserto antiabrasione nella zona del puntale

~~€ 88,00~~  
€ 42,90



S3 SRC ESD

Taglie disponibili: da 35 a 48  
da 072140235 a 072140248

**BASIC**



- Puntale in acciaio
- Lamina antiperforazione in acciaio

**7241NC**

Scarpe basse in pelle idrorepellente

~~€ 45,50~~  
**€ 25,90**



**S3 FO SR**

Taglie disponibili: da 35 a 48  
da 072411635 a 072411648

**7243NC**

Scarpe alte in pelle idrorepellente con rapido sfilamento

~~€ 47,00~~  
**€ 26,90**



**RAPIDO SFILAMENTO**

**S3 FO SR RS**

Taglie disponibili: da 35 a 48  
da 072431635 a 072431648

**7246NB**

Scarpe basse in pelle scamosciata traforata

~~€ 44,00~~  
**€ 24,90**



**S1P FO SR**

Taglie disponibili: da 35 a 48  
da 072461635 a 072461648

**7248NB**

Scarpe alte in pelle scamosciata con rapido sfilamento

~~€ 47,00~~  
**€ 26,90**



**RAPIDO SFILAMENTO**

**S1P FO SR RS**

Taglie disponibili: da 35 a 48  
da 072481635 a 072481648

**7247NB**

Sandali in pelle

~~€ 43,50~~  
**€ 24,80**



**S1P FO SR**

Taglie disponibili: da 35 a 48  
da 072470635 a 072470648

**7245NB**

Scarpe alte in pelle idrorepellente con rapido sfilamento e patella di protezione frontale con chiusura a strappo

~~€ 51,00~~  
**€ 28,90**



**RAPIDO SFILAMENTO**

**S3 FO SR RS**

Taglie disponibili: da 35 a 48  
da 072451635 a 072451648

**NEW**

**BASIC PLUS**

- Punta in composito
- Lamina antiperforazione in fibra composita



**7200BP**

Scarpe basse in pelle scamosciata con inserti in mesh ad alta traspirabilità

~~€ 55,00~~  
**€ 32,00**



S1PS FO SR

Taglie disponibili: da 35 a 48  
da 072000635 a 072000648

**7201BP**

Sandali in pelle scamosciata con chiusura a strappo

~~€ 59,00~~  
**€ 35,00**



S1PS FO SR

Taglie disponibili: da 35 a 48  
da 072010635 a 072010648

**7202BP**

Scarpe basse in pelle liscia idrorepellente

~~€ 57,00~~  
**€ 33,00**



S3S FO SR

Taglie disponibili: da 35 a 48  
da 072020635 a 072020648

**7203BP**

Scarpe alte in pelle liscia idrorepellente con rapido sfilamento

~~€ 63,00~~  
**€ 37,00**



**RAPIDO SFILAMENTO**

S3S FO SR RS

Taglie disponibili: da 35 a 48  
da 072030635 a 072030648



**RAPIDO SFILAMENTO**

**7204BP**

Scarpe alte in pelle liscia idrorepellente con rapido sfilamento e patella di protezione frontale con chiusura a strappo. Suola in gomma ad alta resistenza.

~~€ 79,00~~  
**€ 47,00**

S3S FO SR HRO RS

Taglie disponibili: da 35 a 48  
da 072040635 a 072040648

**NEW**

**TOP LINE**  
HIGH PERFORMANCE



7342N

**7569NG**

**Giacca 3 in 1 impermeabile, composta da:**

- **Guscio esterno** 100% poliestere con membrana TPU impermeabile, antivento e traspirante (resistenza a colonne d'acqua 8.000 mm - traspirabilità 3.000 mvp)
- **Gilet interno** 100% nylon, **Imbottitura** 100% poliestere 100 g, con cappuccio staccabile,
- **Nero con inserti antracite**

€ 169,00  
**€ 96,00**



	XS	S	M	L	XL	2XL	3XL
	075690000	075690001	075690002	075690003	075690004	075690005	075690006

**7565NG**

**Felpa zip lunga**

- 60% cotone, 40% poliestere, 280 g
- Fondo maniche e vita elasticizzati
- **Nero con inserti antracite**

€ 65,00  
**€ 37,00**



	XS	S	M	L	XL	2XL	3XL
	075650400	075650401	075650402	075650403	075650404	075650405	075650406

**7570NG**

**Pantaloni da lavoro multitasche elasticizzati**

- 94% poliestere, 6% spandex, 140 gr
- Tasche rinforzate, vita elasticizzata
- **Antracite, con inserti neri**
- Slim fit

€ 71,00  
**€ 36,00**

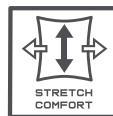

	XS   46	S   48	M   50	L   52	XL   54	2XL   56	3XL   58
	075700000	075700001	075700002	075700003	075700004	075700005	075700006

**7571NG**

**Bermuda da lavoro multitasche elasticizzati**

- 94% poliestere, 6% spandex, 140 gr
- Tasche rinforzate, vita elasticizzata
- **Antracite, con inserti neri**
- Slim fit

€ 61,00  
**€ 29,50**



	XS   46	S   48	M   50	L   52	XL   54	2XL   56	3XL   58
	075710000	075710001	075710002	075710003	075710004	075710005	075710006

### 7982N

Cappellino nero con visiera curva, 100% cotone, chiusura con cinturino, nero



079820000

€ 18,20  
€ 6,00



### 7643G

Felpa zip corta

- 80% cotone, 20% poliestere, 280 g
- Antracite/grigio chiaro



€ 58,00  
€ 28,00



	XS	S	M	L	XL	2XL	3XL
	076430000	076430001	076430002	076430003	076430004	076430005	076430006

### 7820SG

Pantaloni da lavoro multitasche elasticizzati e leggeri

- 39% cotone, 61% poliestere in tessuto mechanical stretch ripstop, 170 g
- Grigio



€ 64,00  
€ 36,50



STRETCH  
RIPSTOP LIGHT & STRONG

	XS   46	S   48	M   50	L   52	XL   54	2XL   56	3XL   58
	078200100	078200101	078200102	078200103	078200104	078200105	078200106

### 7821SG

Bermuda da lavoro multitasche elasticizzati e leggeri

- 39% cotone, 61% poliestere in tessuto mechanical stretch ripstop, 170 g
- Grigio



€ 58,00  
€ 28,00



STRETCH  
RIPSTOP LIGHT & STRONG

	XS   46	S   48	M   50	L   52	XL   54	2XL   56	3XL   58
	078210100	078210101	078210102	078210103	078210104	078210105	078210106



7340VA  
Renegade 80



**7076BP**

Occhiali di protezione con lenti in policarbonato polarizzato scuro

EN ISO 12312-1:2013+A1:2015  
EN 1836  
3P



070760029

~~€ 35,50~~  
**€ 18,00**



**7548T**

T-shirt con stampa moderna

- 100% cotone, 150 g
- Nero

~~€ 15,00~~  
**€ 9,00**



GRUPPI	XS	S	M	L	XL	2XL	3XL
	075480700	075480701	075480702	075480703	075480704	075480705	075480706

**NEW**

**7548D**

T-shirt con stampa in stile graffiti

- 100% cotone, 150 g
- Nero

~~€ 15,00~~  
**€ 9,00**



GRUPPI	XS	S	M	L	XL	2XL	3XL
	075480600	075480601	075480602	075480603	075480604	075480605	075480606

**NEW**

**7528**

Jeans da lavoro elasticizzati

- 98% Cotone denim, 2% tessuto elasticizzato, 280 g

~~€ 62,50~~  
**€ 34,50**



Jeans

**7200BP**

Basic Plus

GRUPPI	XS   46	S   48	M   50	L   52	XL   54	2XL   56	3XL   58
	075000010	075000011	075000012	075000013	075000014	075000015	075000016

### 7076BC

Occhiali di protezione con lenti in policarbonato trasparente

EN 166:2001  
EN 172  
5-1.7 1F



070760009  
~~€ 22,40~~  
**€ 11,00**

### 7529

Bermuda jeans da lavoro elasticizzati

• 98% Cotone denim,  
2% tessuto elasticizzato, 280 g

Jeans



~~€ 49,50~~  
**€ 26,70**

	XS   46	S   48	M   50	L   52	XL   54	2XL   56	3XL   58
	075290046	075290048	075290050	075290052	075290054	075290056	075270058

### 7552

Polo work in cotone piquet 200 g/m<sup>2</sup> con 3 bottoni

~~€ 19,10~~  
**€ 9,90**

**100% COTONE**

	XS	S	M	L	XL	2XL	3XL
<b>7552BL</b>	075520300	075520301	075520302	075520303	075520304	075520305	075520306
<b>7552G</b>	075520400	075520401	075520402	075520403	075520404	075520405	075520406
<b>7552N</b>	075520500	075520501	075520502	075520503	075520504	075520505	075520506

**7552BL**  
Blu



**7552G**  
Grigio scuro melange



**7552N**  
Nero

### 7553

T-shirt work in cotone jersey 150 g/m<sup>2</sup>

~~€ 12,90~~  
**€ 6,90**

**100% COTONE**

	XS	S	M	L	XL	2XL	3XL
<b>7553BL</b>	075530300	075530301	075530302	075530303	075530304	075530305	075530306
<b>7553G</b>	075530400	075530401	075530402	075530403	075530404	075530405	075530406
<b>7553N</b>	075530500	075530501	075530502	075530503	075530504	075530505	075530506
<b>7553V</b>	075530600	075530601	075530602	075530603	075530604	075530605	075530606

**7553BL**  
Blu



**7553G**  
Grigio scuro melange



**7553V**  
Verde salvia

**7553N**  
Nero



### 7550

T-shirt tecnica da lavoro con tecnologia 37.5®

- 70% Poliestere 37.5®
- 30% mesh double face in poliestere
- 120 g/m<sup>2</sup>

**SUPER TRASPIRANTE**

**TECNOLOGIA 37.5®:  
TRASPIRANTE E SKIN-FRIENDLY  
PER UN PERFETTO EQUILIBRIO TERMICO**



~~€ 41,50~~  
**€ 23,50**



	XS	S	M	L	XL	2XL	3XL
<b>7550G</b>	075500400	075500401	075500402	075500403	075500404	075500405	075500406
<b>7550N</b>	075500500	075500501	075500502	075500503	075500504	075500505	075500506

EASY LIGHT 

**7867G**

Gilet leggero da lavoro  
in T/C twill, 180 g

~~€ 58,50~~  
**€ 27,00**

- 65% poliestere, 35% cotone
- Grigio



	XS	S	M	L	XL	2XL	3XL	4XL	5XL
	078670800	078670801	078670802	078670803	078670804	078670805	078670806	078670807	078670808

**7860**

Pantaloni leggeri da lavoro  
in T/C twill, 180 g

~~€ 54,50~~  
**€ 29,00**

- 65% poliestere, 35% cotone
- Tasche per ginocchiere
- Inserti e ginocchiere in "Oxford" poliestere/PU, 220 g



Grigio



Blu



**7861**

Bermuda leggeri da lavoro  
in T/C twill, 180 g

~~€ 45,50~~  
**€ 24,90**

- 65% poliestere, 35% cotone

	XS   46	S   48	M   50	L   52	XL   54	2XL   56	3XL   58	4XL   60	5XL   62
<b>7860B</b> 	078600700	078600701	078600702	078600703	078600704	078600705	078600706	078600707	078600708
<b>7860G</b> 	078600800	078600801	078600802	078600803	078600804	078600805	078600806	078600807	078600808

	XS   46	S   48	M   50	L   52	XL   54	2XL   56	3XL   58	4XL   60	5XL   62
<b>7861B</b> 	078610700	078610701	078610702	078610703	078610704	078610705	078610706	078610707	078610708
<b>7861G</b> 	078610800	078610801	078610802	078610803	078610804	078610805	078610806	078610807	078610808



Blu

Grigio

**7865G**

Tuta leggera da lavoro  
in T/C twill, 180 g

~~€ 87,00~~  
**€ 48,00**

- 65% poliestere, 35% cotone
- Inserti e ginocchiere in "Oxford" poliestere/PU, 220 g
- Grigio



	XS   46	S   48	M   50	L   52	XL   54	2XL   56	3XL   58	4XL   60	5XL   62
	078650800	078650801	078650802	078650803	078650804	078650805	078650806	078650807	078650808



**7246NB**  
Basic  86

## 7642G

Felpa girocollo  
con inserti neri sulle spalle  
e dettaglio verde fluo

- 60% cotone, 40% poliestere, 240 g

~~€ 33,00~~  
€ 18,90



	XS	S	M	L	XL	2XL	3XL
	076420000	076420001	076420002	076420003	076420004	076420005	076420006

## 7984G

Cintura da lavoro  
in 100% TPE e fibbia  
in metallo zinco cromato

Taglia unica 125 cm accorciabile,  
larghezza 35 mm, nero



079840525

~~€ 17,70~~  
€ 10,50



## 7610N

**TREKING**  
LIGHT

Pantaloni "work trekking"  
LIGHT in tessuto elasticizzato

- 90% nylon, 10% tessuto elasticizzato, 140 g
- Nero

~~€ 74,00~~  
€ 42,00



	XS   46	S   48	M   50	L   52	XL   54	2XL   56	3XL   58
	076100100	076100101	076100102	076100103	076100104	076100105	076100106

## 7611G

**TREKING**  
LIGHT

Bermuda "work trekking"  
LIGHT in tessuto elasticizzato

- 90% nylon, 10% tessuto elasticizzato, 140 g
- Grigio

~~€ 56,50~~  
€ 32,00



	XS   46	S   48	M   50	L   52	XL   54	2XL   56	3XL   58
	076110000	076110001	076110002	076110003	076110004	076110005	076110006



7270Y

FitEvolution 83

*Cotton*  

**7937MG**

**Gilet da lavoro**

- 97% cotone, 3% tessuto elasticizzato, 220 g, grigio

~~€ 57,00~~  
**€ 30,50**



	XS	S	M	L	XL	2XL	3XL
	079370400	079370401	079370402	079370403	079370404	079370405	079370406

**7930MG**

**Pantaloni da lavoro multitasche**

- 97% cotone, 3% tessuto elasticizzato, 220 g, grigio
- Vita elasticizzata

~~€ 61,50~~  
**€ 33,50**



	XS   46	S   48	M   50	L   52	XL   54	2XL   56	3XL   58
	079300400	079300401	079300402	079300403	079300404	079300405	079300406

**7931MG**

**Bermuda da lavoro**

- 97% cotone 3% tessuto elasticizzato, 220 g/m<sup>2</sup>, grigio

~~€ 49,50~~  
**€ 27,00**



	XS   46	S   48	M   50	L   52	XL   54	2XL   56	3XL   58
	079310400	079310401	079310402	079310403	079310404	079310405	079310406

**7935MG**

**Tuta da lavoro**

- 97% cotone 3% tessuto elasticizzato, 220 g/m<sup>2</sup>, grigio

~~€ 107,50~~  
**€ 59,00**



	XS   46	S   48	M   50	L   52	XL   54	2XL   56	3XL   58
	079350400	079350401	079350402	079350403	079350404	079350405	079350406



**7340G**  
Renegade   81

GRAPHENE TECHNOLOGY



SCOPRI DI PIÙ



I nostri capi, che incorporano questo materiale rivoluzionario, si caratterizzano per:

- **PROPRIETÀ ANTIBATTERICHE E ANTI-ODORE:** impediscono la proliferazione dei batteri responsabili di cattivi odori;
- **LEGGEREZZA:** essendo il graphene un materiale estremamente leggero e sottile, risultano morbidi e confortevoli;
- **REGOLAZIONE TERMICA:** si adattano dinamicamente alle condizioni climatiche, dissipando il calore nelle giornate calde e trattenendolo nelle giornate fredde;
- **TRASPIRABILITÀ:** permettono una ventilazione ottimale e la dispersione dell'umidità corporea;
- **RESISTENZA:** sono estremamente duraturi.

7647GG

Gilet da lavoro softshell

€ 77,50  
€ 39,90

- Tessuto esterno 96% poliestere, 4% spandex, 280 g
- Tessuto interno 100% poliestere con graphene
- **Grigio/nero**
- Termoregolatore, idrorepellente e traspirante



	XS	S	M	L	XL	2XL	3XL
	076470010	076470011	076470012	076470013	076470014	076470015	076470016

7648GG

Giacca da lavoro softshell

€ 124,50  
€ 69,00

- 96% poliestere, 4% spandex, 310 g
- Materiale interno fleece accoppiato 100% poliestere con graphene
- Dotato di cappuccio staccabile
- Termoregolatore e dotato di membrana TPU impermeabile, antivento e traspirante (resistenza a colonne d'acqua 8.000 mm-traspirabilità 5.000 mvp)
- **Grigio/nero**



	XS	S	M	L	XL	2XL	3XL
	076480010	076480011	076480012	076480013	076480014	076480015	076480016

7640GG

Pantaloni da lavoro multitasche elasticizzati

€ 96,50  
€ 49,90

- 90% nylon con graphene, 10% spandex, 250 g con rinforzi in Oxford 600D, grigio
- Termoregolatore, idrorepellente e ad asciugatura rapida
- Slim fit



	XS   46	S   48	M   50	L   52	XL   54	2XL   56	3XL   58
	076400010	076400011	076400012	076400013	076400014	076400015	076400016

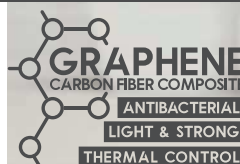

7553V  
90



7271V  
FitEvolution 83

**7398U**

Sottopiedi anatomici in TPR GEL con elevato effetto ammortizzante, supporto dell'arco plantare e cuscinetto nella zona del tallone

~~€ 13,60~~  
**€ 8,20**



7398U 36-40	36-40	073980058
7398U 41-46	41-46	073980063

**7398UP**

Sottopiedi anatomici in TPE GEL con profumo agrumato, design anatomico e supporto dell'arco plantare

~~€ 12,40~~  
**€ 7,50**



7398UP 36-40	36-40	073980076
7398UP 41-46	41-46	073980081

**7431P**

Due paia di calzini sneaker con inserti in texture traspirante

~~€ 8,45~~  
**€ 5,00**

- Rinforzi in nylon e cotone su punta e tallone
- Polsino anatomico
- Restringimento elastico sul collo del piede
- Pianta in nylon intrecciato con naturale fibra di bamboo



7431P 39/42	39/42	074310102
7431P 43/46	43/46	074310104

**7427**

Calze maxi sneaker con inserti protettivi e traspiranti su zona tibia e collo del piede

~~€ 9,55~~  
**€ 5,80**

- Rinforzi in nylon e cotone su pianta e tallone
- Polsino anatomico
- Rinforzi protettivi con apertura traspiranti su zona tibia, collo del piede e tallone
- Pianta in naturale fibra di bamboo spugnata



7427 39/42	39/42	074270002
7427 43/46	43/46	074270004

**7800I**

Coppia ginocchiere interne da lavoro in 100% EVA, nero, TAGLIA UNICA

**078000100**

~~€ 14,70~~  
**€ 7,00**

EN 14404-3:2024  
Tipo 2, Livello 1



**NEW**

**7810E**

Coppia ginocchiere esterne da lavoro con con doppia fascia elastica di chiusura, nero, TAGLIA UNICA

**078100100**

~~€ 28,00~~  
**€ 15,00**

EN 14404:2004+A1:2010  
Tipo 2, Livello 1



**NEW**

### 9563U

**Poltrona per ufficio ergonomica, con braccioli**

- Altezza schienale: 97 cm
- Dimensioni seduta: 50 cm x 53 cm
- Altezza totale sedia: 133-144 cm
- Base: 35 cm (lunghezza gamba) x 49 cm (altezza)



095630020

~~€ 567,00~~  
**€ 255,00**

### 9563G

**Poltrona per ufficio, per ospiti**

- Altezza schienale: 60 cm
- Dimensioni seduta: 45 cm x 51 cm
- Altezza totale sedia: 110-120 cm
- Base: 28 cm (lunghezza gamba) x 50-60 cm (altezza)



095630050

~~€ 273,00~~  
**€ 134,00**

### 9526MC

**Macchina per caffè espresso in capsule compatibile con capsule Nespresso®**

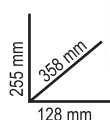

095260020

~~€ 252,00~~  
**€ 146,00**



### 9526F

**Mini-Frigorifero Beta nero da 65L**

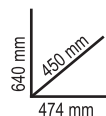

095260005

~~€ 579,00~~  
**€ 350,00**



### 9574

**Guanto da lavoro, on polsino elastico elasticizzato, pollice ed indice rinforzati, in pelle sintetica che consente l'uso di dispositivi touchscreen**



	M	L	XL	2XL
<b>9574B</b>	095740102	095740103	095740104	095740105
<b>95740</b>	095740202	095740203	095740204	095740205



~~€ 41,50~~  
**€ 19,50**



### 9525WB

**Cappellino Beta da baseball bianco con visiera curva**

095251032

~~€ 18,60~~  
**€ 11,00**



### 9528C

**Pallone da calcio con rivestimento esterno in PU, size 5**

- Circonferenza: 68-70 cm
- Pannelli: 12
- Peso: 410-430 gr
- Pressione consigliata: 6-8 lbs/ 0.41 0.55bar/ 6-8 psi

095280100

~~€ 31,00~~  
**€ 16,00**





# 2025 MOTO2 WORLD CHAMPIONSHIP

CELESTINO VIETTI

ALONSO LÓPEZ



998016300



Beta Utensili S.p.A.

via Volta, 18 | 20845 Sovico (MB)

tel. 03 999 99771 | [www.beta-utensili.com](http://www.beta-utensili.com)



© 2024 Beta Utensili S.p.A. - All rights reserved.