

Product range _____
Backwater protection

 **KESSEL**

Make the right choice

Backwater protection



Backwater valves
Backwater chambers

 Made in Germany

www.kessel.com

This is KESSEL.

Since 1963, KESSEL has stood like no other company for innovative and reliable drainage technology. We have established ourselves as the impulse generator in the industry and are now a worldwide premium supplier.



Competent partner
since 1963



International player
60+
countries



Innovative premium supplier
3.000+
products



Safe employer
765
employees



Sustainable company
141,5 mio. €
in sales

During the production of our products as well as their operation on-site, we keep quality assurance, environmental protection and worker's safety at the top of our list.

We also place great value in the relationship with our customer, providing consultation, installation support, commissioning and after-sales service.

One thing is certain, our innovation, quality, reliability and service is number one in the industry.

KESSEL – Leading in drainage



Made in Germany



KESSEL Headquarters Lenting, Germany

Leading in drainage.

No matter whether the task involves discharging water, wastewater treatment or backwater protection: if the best solution is required, there is no option but KESSEL.



Backwater protection

Backwater valves
Backwater chambers



Pump technology

Backwater pumping station
Hybrid lifting station
Lifting stations
Pumping stations
Submersible pumps,
conversions and control units



Drains & channels

Bathroom drains
Floor drains
Basement drains
Outdoor drains



Separators

Grease separators
Coalescence / Oil /
Fuel separators
Sediment separators
Starch separators

Everything from one source The KESSEL system



Bathroom drains

- Floor drains
- Shower channels
- Wall drains



Stainless steel drains

- Floor drains
- Floor trays
- Box channels
- Slotted channels

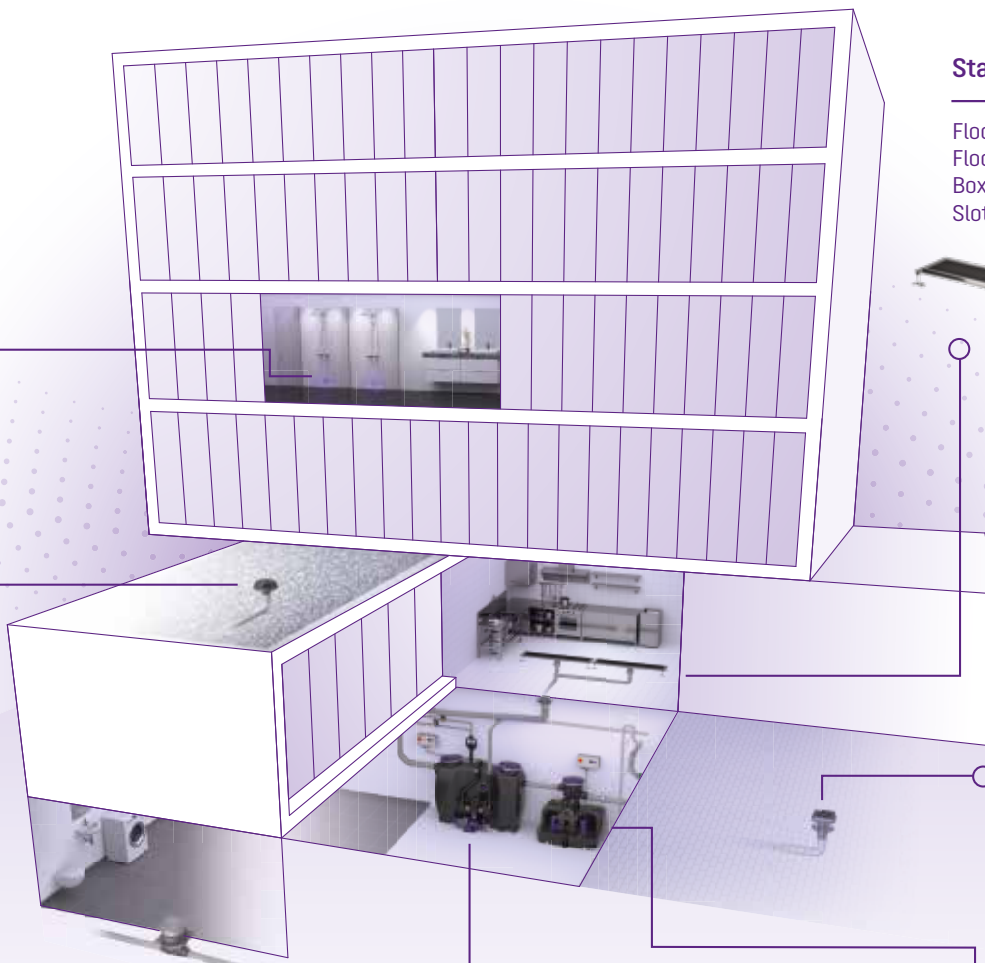

Outdoor drains

- Roof drains
- Gutter drains



Outdoor drains

- Floor drains
- Yard drains
- Parking deck drains



Backwater protection

- Backwater valves
- Backwater chambers
- Backwater pumping stations



Separators

- Grease separators
- Light liquid separators
- Starch separators
- Sediment separators



Pumping technology

- Lifting stations
- Pumping stations
- Submersible pumps
- Hybrid lifting stations



KESSEL SmartServices

Our digital services offer

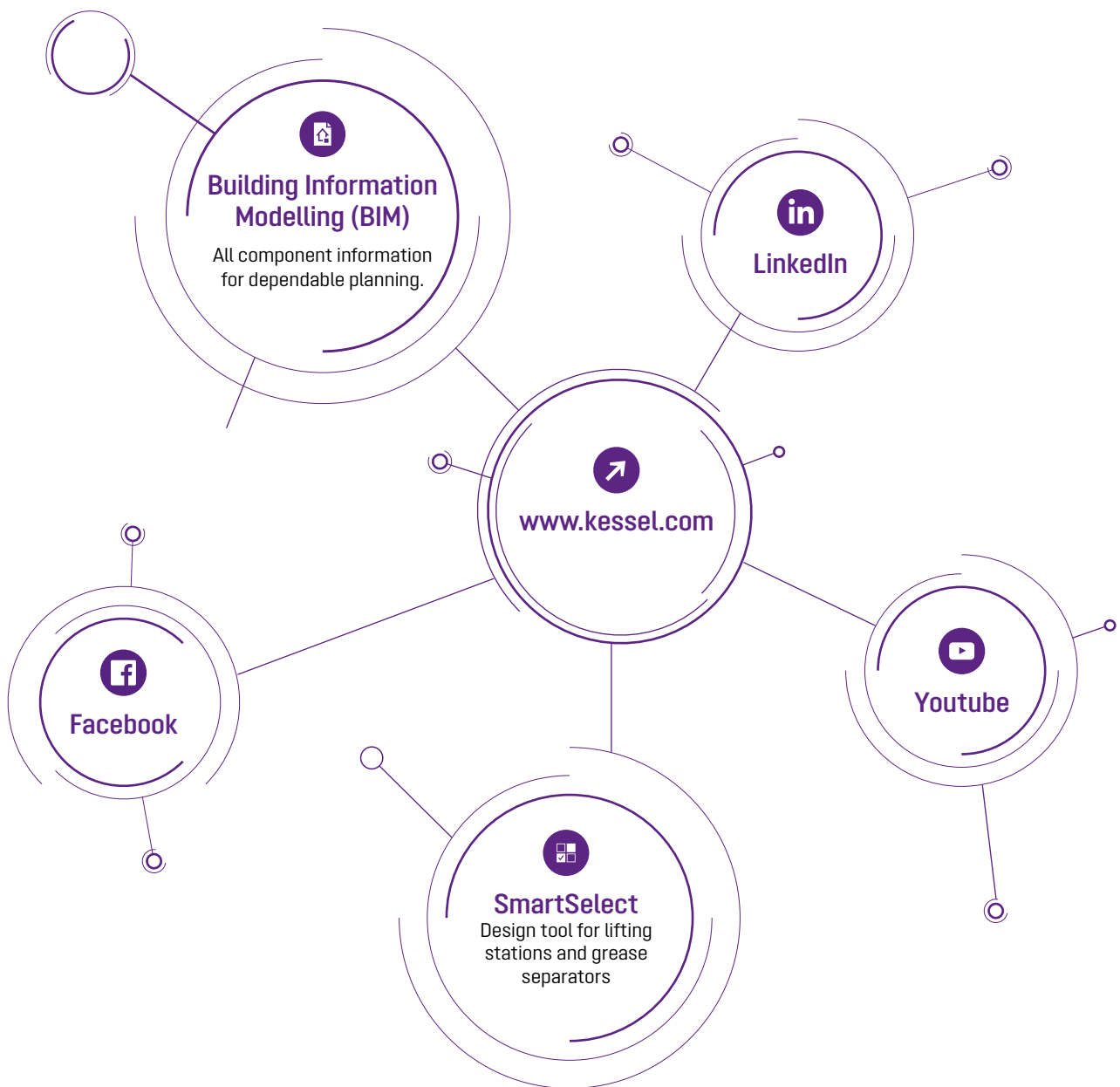

Stay up to date:
get always the newest information
about KESSEL and our products



BIM



LinkedIn



Facebook



SmartSelect



Youtube

Overview of Backwater protection range

Backwater valves



Backwater pumping station
Pumpfix F

➤ Page 12



Backwater valve
Staufix
Ø 110, 125, 160, 200

➤ Page 22



Backwater valve
Staufix FKA

➤ Page 16



Backwater valve
Staufix Basic
Ø 100, 110, 125, 160, 200

➤ Page 28



Backwater valve
Staufix SWA

➤ Page 18



Backwater valve
Staufix
Ø 50 or Ø 75

➤ Page 31



Clean out
Controlfix

➤ Page 20



Can be converted to:
Pumpfix F, Staufix FKA,
Staufix SWA



Backwater valve
Multitube
Ø 260, 320, 410, 515

➤ Page 34



Backwater valve
Pipe flap
Ø 110 - 1000

➤ Page 35

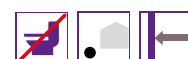



Backwater chambers for backwater valves



Backwater chamber
Standard backwater chamber
Ø 1000 with *Controlfix*

➤ Page 39



Can be converted to:
Pumpfix F, Staufix FKA,
Staufix SWA



Modular backwater chamber
Ø 1000 with *Controlfix*

➤ Page 39



Can be converted to:
Pumpfix F, Staufix FKA,
Staufix SWA

Type of wastewater



Wastewater containing sewage



Wastewater without sewage

Installation situation



Outdoor, underground installation



Indoor, exposed installation



Floor slab installation

Function



Protects in the event of backwater



Protects and disposes in the event
of backwater

Basement drains



Backwater pumping station
Pumpfix S

➤ Page 46



Backwater valve
Universale Plus

➤ Page 47



Backwater valve
The Universal

➤ Page 48



Backwater valve
Drehfix

➤ Page 49



Everything specialists need to know

What is backwater and what criteria must be noted for the correct product choice?

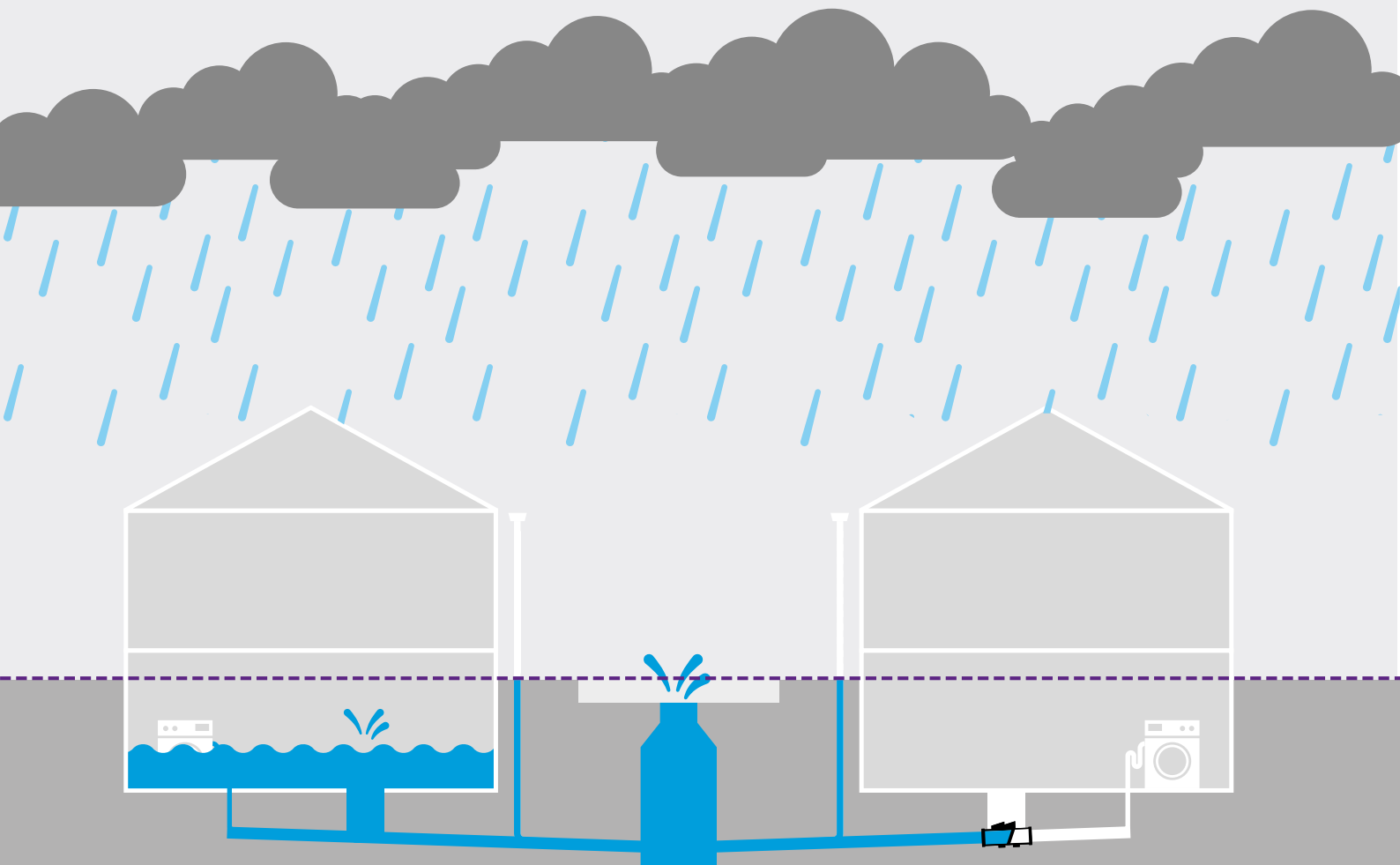

Water drainage system without backwater protection

During heavy rain, the water level rises above the so-called backwater level. This term is usually used to mean street level. Rooms in the basement or cellar quickly become flooded. The results are significant damage and costs.

Water drainage system with backwater protection

Wastewater that flows with a slope to the sewer will be protected by a backwater valve. In the event of backwater, the flap closes so that no wastewater can enter the building. If the public sewer is higher than the drainage spot in the building, the wastewater must be pumped above the backwater level, for example via an Aqualift lifting station from KESSEL.

KESSEL backwater valves according to EN 13564

With mechanical flap system

Staufix and *Staufix SWA* backwater valves are available with one or two vertically hanging flaps. Additionally they can be equipped with a flap locking lever.

Type 0 Backwater valve for use in horizontal pipes with one closure flap.

Type 1 Backwater valve for use in horizontal pipes with one self actuating closure flap equipped with locking lever.

Type 2 Backwater valve for use in horizontal pipes with two self actuating closure flaps one of which equipped with a locking lever.

Type 4 Floor drain with integrated self actuating closure flap equipped with locking lever.

Type 5 Floor drain with two integrated self actuating closure flaps one of which is equipped with a locking lever.



With electronic open flap system

The *Staufix FKA* has two open flaps. One closes electrically during backwater and additionally it has a back-up manually closable flap. This is the ideal product for use with raw sewage.

Type 3 Backwater valve for use in horizontal pipes with an automated closure flap operated by external energy (electric, pneumatic or other) and a second back-up manual closure flap.



With electronic open flap system and sewage pump

The flap of the *Pumpfix F* closes electrically and the integrated sewage pump discharges the building's wastewater into the sewer during backwater.

Type 3 Backwater valve for use in horizontal pipes with an automated closure flap operated by external energy (electric, pneumatic or other) and a second back-up manual closure flap.



Installation situation

There are three options for installing backwater protection.

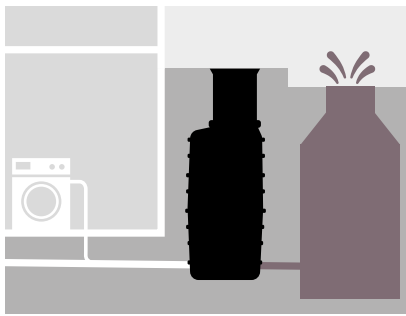

Outdoor, underground installation

This is the most practical solution. Products to protect against water ingress are installed in a chamber in the ground in front of the building. This saves space in the basement, noise nuisance can be practically ruled out and the installation is functionally secure and maintenance-friendly.

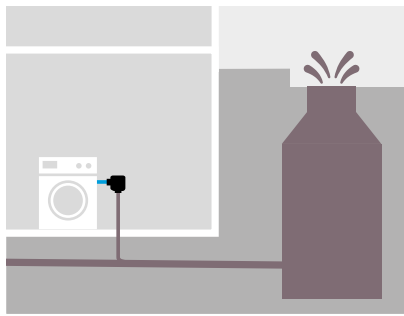

Exposed installation

This is the simplest solution as it does not require a great deal of structural rework. This means that the installation is quick and that the backwater protection unit is always easily accessible for maintenance and cleaning.

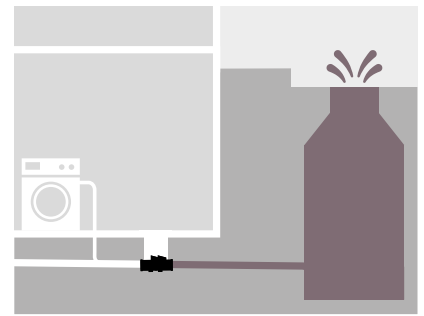

Floor slab installation

This is the most convenient solution. With floor slab installation, the backwater valve takes up no living space as it is unobtrusively installed in the underfloor. However, it is still accessible for maintenance or repair via the cover. Ideal for new construction.

Types of wastewater

In principle, we differentiate between two different types of wastewater. Different backwater protection devices can be considered depending on the type of wastewater being dealt with.



Wastewater with sewage

is water with faecal content coming from urinals or toilets to the sewer. This is termed "black water".



Wastewater without sewage

is water without faecal content, for example shower water or water from a washing machine. This is termed "grey water".

Slope to the public sewer

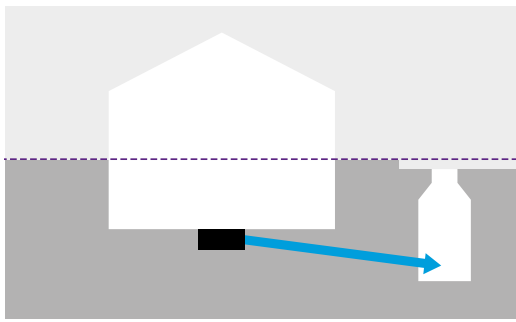

Slope to the public sewer

Backwater valves and hybrid lifting stations can be used here.

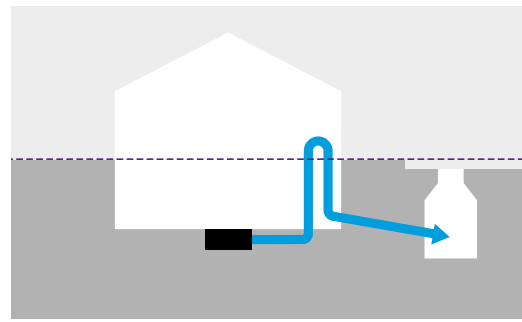

No slope to the public sewer

If the public sewer is higher than the basement level, the wastewater must be lifted to the sewage pipe with a lifting station via a backwater loop.

Function

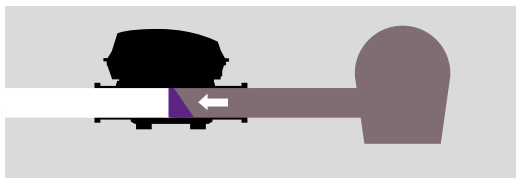

Protects in the event of backwater

The backwater flap prevents wastewater from the public sewer from backing up through the drainage pipe and flooding the building.

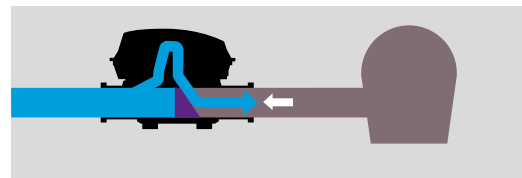

Disposes in the event of backwater

Despite backwater from the public sewer and closed backwater flap(s), domestic wastewater can be disposed of via a pump. This ensures that the building's drainage system functions even in the event of backwater.

Backwater pumping station *Pumpfix F*

The unique backwater solution.

More than a backwater valve: *Pumpfix F* is the only backwater valve that pumps against backwater. In normal operation, the backwater pumping station continuously disposes of the wastewater via the slope to the main sewer, making it energy-neutral. In the event of backwater, the backwater flap closes automatically to protect the building from flooding and any wastewater from the building is pumped into the flooded sewer via the integrated sewage. The integrated cutting system shreds solids meaning the *Pumpfix F* can be used with wastewater containing sewage. It can also drain basement staircases up to 5 m².

Pumpfix F is available in two variants – for installation in an exposed drainage pipe and for floor slab installation, where you can choose between a black cover or tileable cover.

Application

For flats under the backwater level with no access to a toilet above backwater level.

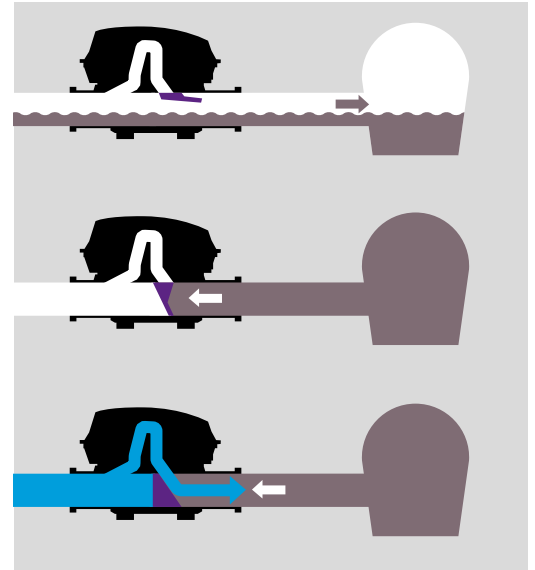

How it works

Pumpfix F is the only backwater valve with hybrid function: In normal operation it uses the natural slope to the sewage pipe. In the event of backwater from the sewage pipe, the pump is automatically switched on in order to reliably pump the building's wastewater into the flooded sewer.



1 Backwater pumping station 2 Control unit 3 Sealing gasket set



1 Backwater pumping station 2 Control unit

Ventilation

Integrated ventilation eliminates the requirement for costly roof ventilation pipes

Motor

Automatically closes the backwater flap in the event of backwater

Body with only 9 mm integrated slope

Ideal for renovation work

Installation kit for the floor slab with integrated drainage function

The backwater valve is available for floor slab installation and can also be installed in waterproof concrete by using an extension piece with sealing flange and an elastomer waterproofing membrane. The integrated drainage function ensures that any surface water, for example due to a pipe break, will be pumped into the sewer even during times of backwater.

Pumpfix F
 Article numbers • Data sheets
 Accessories • Spareparts
 Videos • Download • BIM
www.kessel.com/pumpfix-f

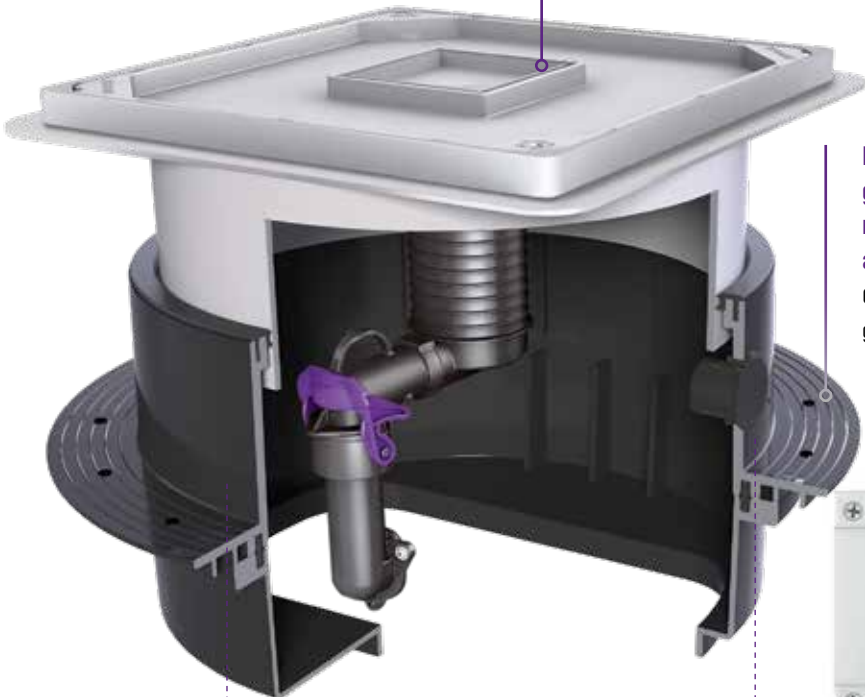

Flange for groundwater resistance available.
 Optional with gasket set.

Comfort control unit
 with multilingual (EN, DE, FR, IT, PL, NL) digital display for operating state and servicing instructions as well as connection option for building management system



Plug & Play control unit
 with self-diagnosis system SDS for maximum safety

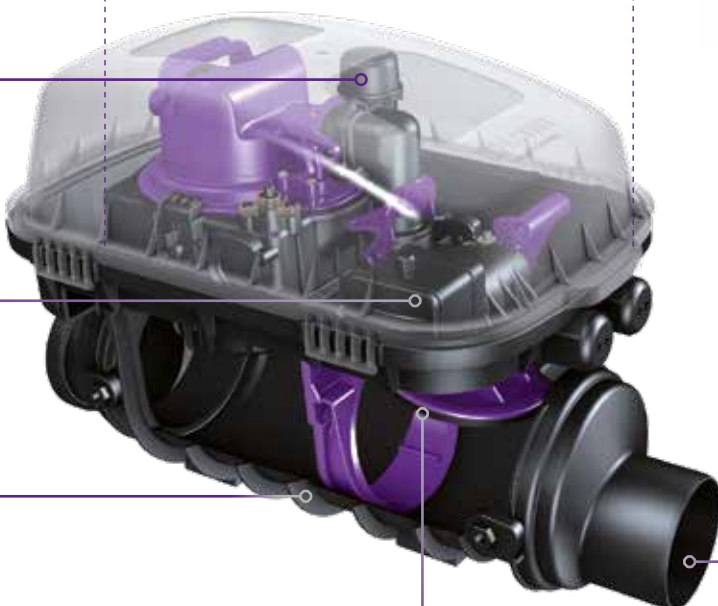

Motorized Flap
 Closed backwater flap with integrated gasket provides secure and reliable protection during backwater

Removable inlet / outlet connections – also in Ø 200

- Flange/spigot for customized connections
- Variable inlet and outlet sizes available

Backwater pumping station *Pumpfix F*

Installation in a concrete slab / floor



Z-53.2-388

Made of polymer, with telescopic upper section for continuous height- and level adjustment. For installation depth (D) from 486 – 640 mm, Installation area 750 × 750 mm. With surface water tight polymer cover plate class A 15 and integrated floor drain.

Installation kit with choice of cover. Backwater pumping station according to EN 13564 Type 3 with pump (1kW/230V) and backwater valve, pump activates during backwater, suitable for wastewater with or without sewage.

Plug-and-Play control unit with connection option to building management system and alarm, display for operating status and battery back-up, protection type IP 54, with integrated self diagnosis system SDS, motorized backwater flap, *Pumpfix F* body rated protection type IP 68 (3 m, 24 h).

Power cable length: 5 m (15 m available on request).

Accessories:

Extension sections for installation in waterproof concrete see page 36



Outer diameter Ø (mm)	L × H in mm	Art. no.
-----------------------	-------------	----------

With recessed cover for on-site tiling with integrated drain		
Ø 110	642 × 394	24 100X
Ø 125	645 × 387	24 125X
Ø 160	656 × 370	24 150X
Ø 200*	720 × 348	24 200X

With black cover with integrated drain		
Ø 110	642 × 394	24 100S
Ø 125	645 × 387	24 125S
Ø 160	656 × 370	24 150S
Ø 200*	720 × 348	24 200S

Pumping capacity

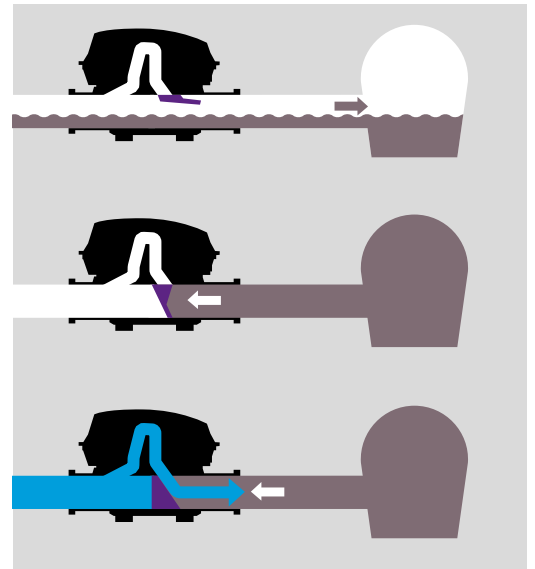
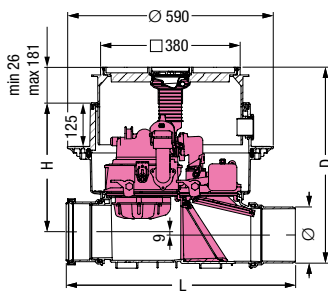
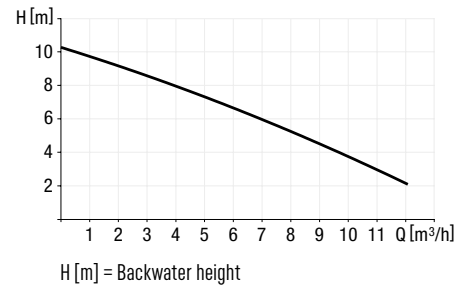

How it works

Pumpfix F is the only backwater valve with hybrid function: In normal operation it uses the natural slope to the sewage pipe. In the event of backwater from the sewage pipe, the pump is automatically switched on in order to reliably pump the building's wastewater into the flooded sewer.

* In-/Outlet Ø 200, hydraulics corresponds to Ø 160



Backwater pumping station *Pumpfix F*

Installation in an exposed wastewater pipe



Z-53.2-388

Made of polymer, with protective cover. Backwater pumping station according to EN 13564 Type 3 with pump (1kW/230V) and backwater valve, pump activates during backwater, suitable for wastewater with or without sewage.

Plug-and-Play control unit with connection option to building management system and alarm, display for operating status and battery back-up, protection type IP 54, with integrated self diagnosis system SDS, motorized backwater flap, *Pumpfix F* body rated protection type IP 68 (3 m, 24 h).

Power cable length: 5 m (15 m available on request).



Outer diameter Ø (mm)	L x H in mm	Art. no.
Ø 110	642 x 422	24 100
Ø 125	645 x 422	24 125
Ø 160	656 x 422	24 150
Ø 200*	720 x 422	24 200

Pumping capacity

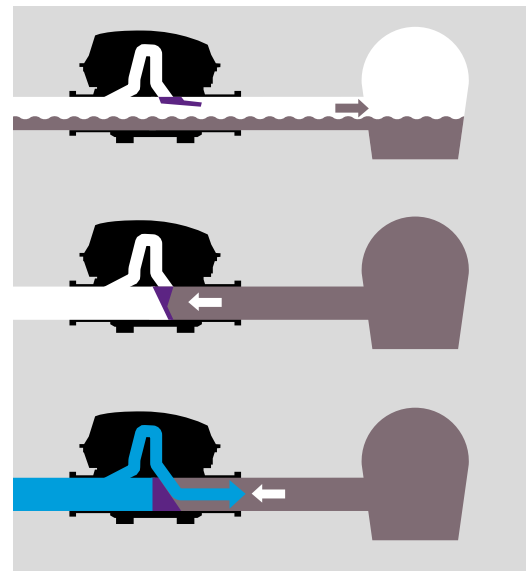
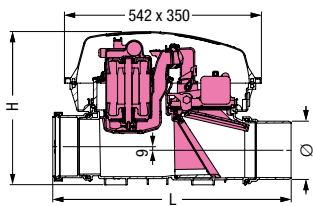
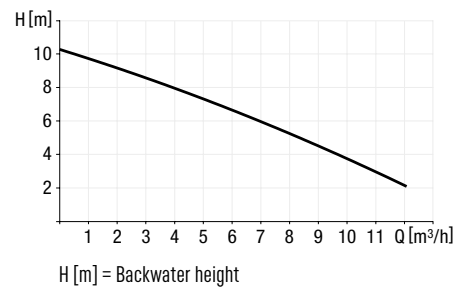

How it works

Pumpfix F is the only backwater valve with hybrid function: In normal operation it uses the natural slope to the sewage pipe. In the event of backwater from the sewage pipe, the pump is automatically switched on in order to reliably pump the building's wastewater into the flooded sewer.

* In-/Outlet Ø 200, hydraulics corresponds to Ø 160



Backwater valves

Staufix FKA

The reliable solution for wastewater with sewage.

Particularly reliable motor operation: In contrast to conventional backwater valves, the *Staufix FKA* closes the backwater flap with the help of a motor. This means that it is also suitable for wastewater containing sewage – not only for showers, washbasins and washing machines, but also for toilets.

Staufix FKA is available in two variants – for installation in an exposed drainage pipe and for floor slab installation, where you can choose between a black cover or tileable cover.

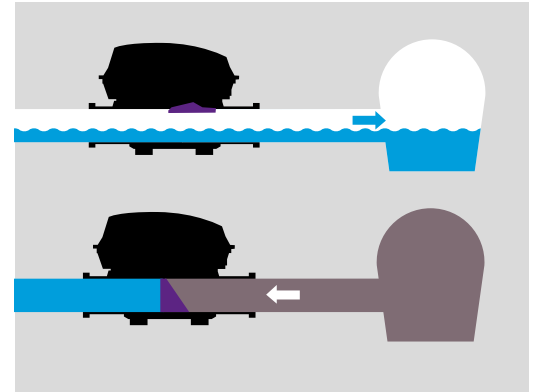

How it works

During normal operations, both flaps are open so that all the wastewater can drain away fully. In the event of backwater from the sewer, the flap is closed and locked by a motor and then opened again automatically afterwards.



1 Backwater valve 2 Control unit



1 Backwater valve 2 Control unit 3 Sealing gasket set



Installation kit for the floor slab

The backwater valve is available for floor slab installation with a tileable cover and can also be installed in waterproof concrete by using an extension piece with central flange and an elastomer waterproofing membrane.

The backwater valve has a plug-in, fully wired, convenient control unit with SDS self-diagnosis system.

Backwater valve *Staufix FKA*

Installation in a concrete slab / floor



CE EN 13564 Type 3 F

Made of polymer, with telescopic upper section for continuous height- and level adjustment. For installation depth (D) from 486 – 640 mm, Installation area 750 × 750 mm With surface water tight cover plate class A 15 made of polymer. Installation kit with choice of cover. Backwater valve according to EN 13564 Type 3 with two open flaps. Plug-and-Play control unit with connection option to building management system and alarm, protection type IP 54, with integrated self diagnosis system SDS, display for operating status and battery back-up, motor is rated protection Type IP 68 (3 m, 24 h). Supply voltage/-frequency: 230 V AC/50 Hz. **Power cable length:** 5 m (15 m available on request).

Accessories:

- Extension sections for installation in waterproof concrete see page 36
- Conversion kits see page 21

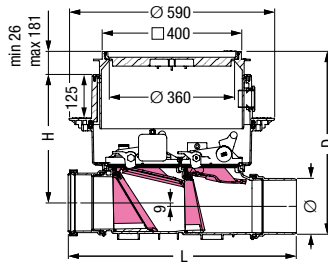

Outer diameter Ø (mm)	L × H in mm	Art. no.
--------------------------	-------------	----------

With recessed cover for on-site tiling

Ø 110	642 × 394	84 100X
Ø 125	645 × 387	84 125X
Ø 160	656 × 370	84 150X
Ø 200*	720 × 348	84 200X

With black cover

Ø 110	642 × 394	84 100S
Ø 125	645 × 387	84 125S
Ø 160	656 × 370	84 150S
Ø 200*	720 × 348	84 200S



* In-/Outlet Ø 200, hydraulics corresponds to Ø 160

Backwater valve *Staufix FKA*

Installation in an exposed wastewater pipe



CE EN 13564 Type 3 F

Made of polymer, with protective cover. Backwater valve according to EN 13564 Type 3 with two open flaps. Plug-and-Play control unit with connection option to building management system and alarm, display for operating status and battery back-up, protection type IP 54, with integrated self diagnosis system SDS, display for operating status and battery back-up, motor is rated protection Type IP 68 (3 m, 24 h). Supply voltage/-frequency: 230 V AC/50 Hz. **Power cable length:** 5 m (15 m available on request).

Accessories: Conversion kits see page 21

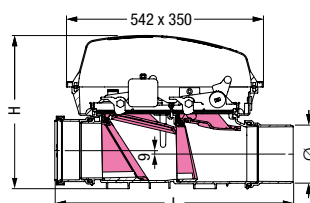

Outer diameter Ø (mm)	L × H in mm	Art. no.
--------------------------	-------------	----------

Ø 110	642 × 422	84 100
Ø 125	645 × 422	84 125
Ø 160	656 × 422	84 150
Ø 200*	720 × 422	84 200



* In-/Outlet Ø 200, hydraulics corresponds to Ø 160

Backwater valves

Staufix SWA

The reliable solution for wastewater

Double security with two pendulum flaps: The *Staufix SWA* backwater valve for wastewater offers absolute security in protection against backwater. In the event of backwater, the outer flap closes with the second flap providing additional security. The system can also be locked with a manually actuated emergency closure. *Staufix SWA* is suitable for showers, washbasins and washing machines.

Staufix SWA is available in two versions – for installation in an exposed drainage pipe and for floor slab installation, where you can choose between a black cover or tileable cover.

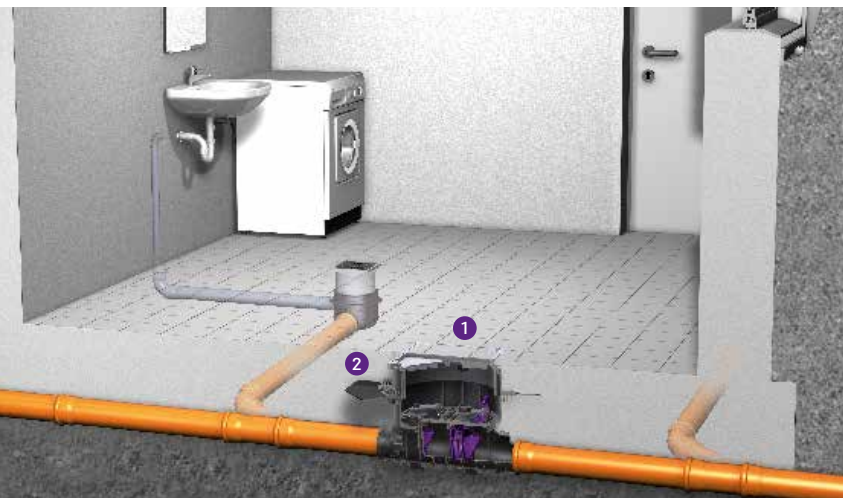

1 Backwater valve 2 Sealing gasket set



1 Backwater valve

Staufix SWA

Article numbers • Data sheets
Accessories • Spareparts
Videos • Download • BIM



www.kessel.com/staufix-swa



Simple conversion

The *Staufix SWA* backwater valve can be retrofitted with the *Staufix FKA* and *Pumpfix F* conversion kits – even in its installed state.

➤ Backwater valve *Staufix FKA*

Page 16

➤ Backwater pumping station *Pumpfix F*

Page 12

➤ Conversion kits

Page 21

Twin flap backwater valve *Staufix SWA*

Installation in a concrete slab / floor



CE EN 13564 Type 2

Made of polymer, with telescopic upper section for continuous height- and level adjustment. For installation depth (D) from 486 – 640 mm, Installation area 750 × 750 mm. With surface water tight cover plate class A 15 made of polymer.

Installation kit with choice of cover.

Backwater valve according to EN 13564 Type 2 with two self-closing flaps, one of which can be locked by hand as an emergency closure.

➤ Accessories:

- Extension sections for installation in waterproof concrete see page 36
- Conversion kits see page 21



Outer diameter Ø (mm)	L × H in mm	Art. no.
--------------------------	-------------	----------

With recessed cover for on-site tiling

Ø 110	642 × 394	73 100.10X
Ø 125	645 × 387	73 125.10X
Ø 160	656 × 370	73 150.10X
Ø 200*	720 × 348	73 200.10X

With black cover

Ø 110	642 × 394	73 100.10S
Ø 125	645 × 387	73 125.10S
Ø 160	656 × 370	73 150.10S
Ø 200*	720 × 348	73 200.10S

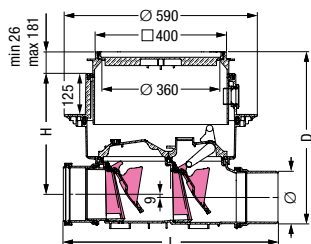

* In-/Outlet Ø 200, hydraulics corresponds to Ø 160

Twin flap backwater valve *Staufix SWA*

Installation in an exposed wastewater pipe



CE EN 13564 Type 2

Made of polymer, with protective cover.

Backwater valve according to EN 13564 Type 2 with two self-closing flaps, one of which can be locked by hand as an emergency closure.

➤ Accessories:

Conversion kits see page 21



Outer diameter Ø (mm)	L × H in mm	Art. no.
--------------------------	-------------	----------

Ø 110	642 × 422	73 100.10
Ø 125	645 × 422	73 125.10
Ø 160	656 × 422	73 150.10
Ø 200*	720 × 422	73 200.10

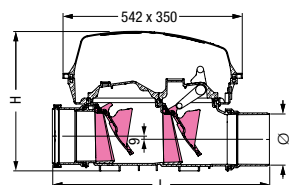

* In-/Outlet Ø 200, hydraulics corresponds to Ø 160

Clean out *Controlfix*

The practical upgrade solution.

The foundation stone for your safety: Clean outs are installed at regular intervals in the drainage pipes in order to be able to clear out any blockages more easily. Our clean out *Controlfix* also facilitates this task further with its practical quick-release closures, enabling you to carry out maintenance quickly and without the need for tools.

Would you like to retain the option to retrospectively equip your drainage pipe with a backwater valve? The *Controlfix* clean out is ideally suited for this too – as it can be easily upgraded in situ to a *Staufix* backwater valve or a *Pumpfix F* backwater pumping station!

Controlfix

Article numbers • Data sheets
Accessories • Spareparts
Videos • Download • BIM

www.kessel.com/controlfix



Clean out *Controlfix*

Installation in a concrete slab / floor

Made of polymer, with telescopic upper section for continuous height- and level adjustment. For installation depth (D) from 486 – 640 mm, Installation area 750 × 750 mm. With surface water tight cover plate class A 15 made of polymer.

Installation kit with choice of cover.

➤ Accessories:

- Extension sections for installation in waterproof concrete see page 36
- Conversion kits see page 21



Outer diameter Ø (mm)	L × H in mm	Art. no.
With recessed cover for on-site tiling		
Ø 110	642 × 394	80 100X
Ø 125	645 × 387	80 125X
Ø 160	656 × 370	80 150X
Ø 200*	720 × 348	80 200X
With black cover		
Ø 110	642 × 394	80 100S
Ø 125	645 × 387	80 125S
Ø 160	656 × 370	80 150S
Ø 200*	720 × 348	80 200S

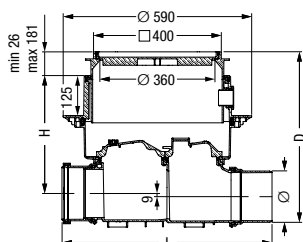

* In-/Outlet Ø 200, hydraulics corresponds to Ø 160

Clean out *Controlfix*

Installation in an exposed wastewater pipe



Made of polymer, with protective cover.

Accessories:

Conversion kits see below

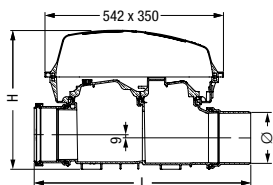

Outer diameter Ø (mm)	L x H in mm	Art. no.
Ø 110	642 x 422	80 100
Ø 125	645 x 422	80 125
Ø 160	656 x 422	80 150
Ø 200*	720 x 422	80 200

* In-/Outlet Ø 200, hydraulics corresponds to Ø 160

Conversion kits

for *Pumpfix F*, *Staufix FKA* and *Staufix SWA* models made on or after Jan 2011

		Art. no.
Backwater pumping <i>Pumpfix F</i> for installation in a concrete slab/floor	Compatibility: For Ø 110 – Ø 200* Inclusive: Comfort control unit with recessed cover for on-site tiling and drain, <i>Multistop</i> , gasket Cable length: 5 m ↗ Cable extension: See page 36	 80 098
Backwater pumping <i>Pumpfix F</i> for installation in an exposed wastewater pipe	Compatibility: For Ø 110 – Ø 200* Inclusive: Comfort control unit Cable length: 5 m ↗ Cable extension: See page 36	 80 097
Motorized backwater valve <i>Staufix FKA</i>	Compatibility: For installation in a concrete slab/floor and in an exposed wastewater pipe, for Ø 110 – Ø 200* Inclusive: Comfort control unit Cable length: 5 m ↗ Cable extension: See page 36	 80 093
Backwater valve <i>Staufix SWA</i>	Compatibility: For installation in a concrete slab/floor and in an exposed wastewater pipe, for Ø 110 – Ø 200* * In-/Outlet Ø 200, hydraulics corresponds to Ø 160	 80 091

Backwater valves

Staufix

The original solution for wastewater without sewage.

You can't improve on an original... But we can! The new *Staufix* is the result of decades of product development and optimisation. It is now even more compact, allowing a simpler installation and more flexible mounting.

Staufix is each available in two variants – for installation in an exposed drainage pipe and for floor slab installation, where you can choose between a black cover or tileable cover.

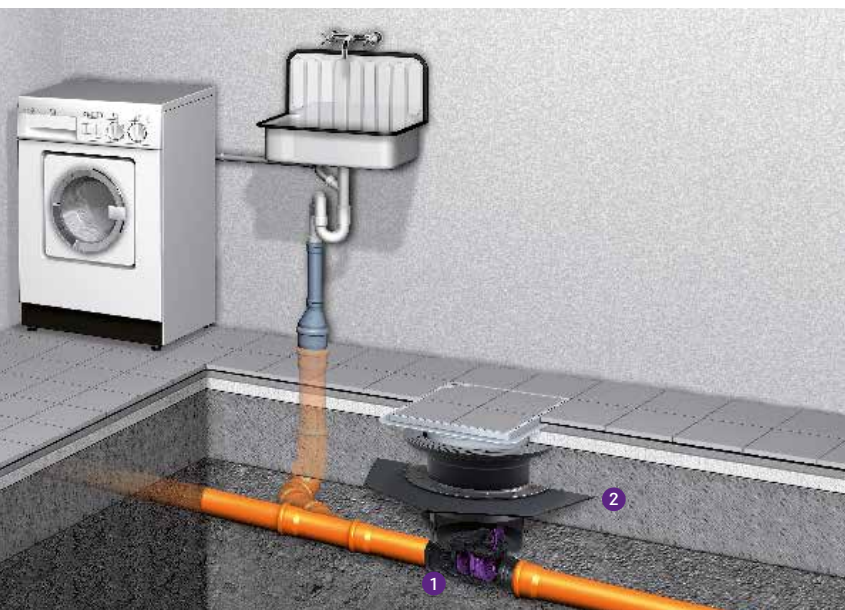
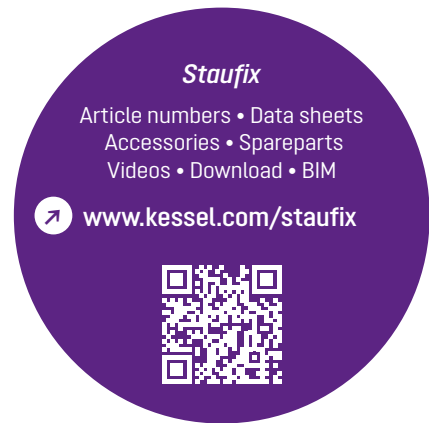

1 Backwater valve 2 Extension section

Flexibly installable

The new installation kit is available with three different extension sections and can therefore be installed flexibly at depths of up to 65 cm. Choose from a standard extension section, an extension section with flange, and mating flange made of stainless steel as well as with elastomer waterproofing membrane for deeper installation in waterproof concrete.

Individually combinable

The sockets and spigots are available in the same or in different nominal inlet and outlet sizes – and can be individually combined with different drain bodies. The interchangeable sockets therefore flexibly fit on all standard pipes. This is especially practical if old and new pipes have to be joined in case of structural alterations or renovation work.

Installation situation

The backwater valves *Staufix* can be installed either in an exposed drainage pipe or in the floor slab – convenient and tidy thanks to the installation kit with telescopic upper section. Even installation in waterproof concrete is possible by means of an extension piece with flange and an elastomer waterproofing membrane.



Individually combinable

The sockets and spigots are available with the same sizes or different inlet and outlet sizes – and can be individually combined with two different pipe sizes. The two-way sockets thus fit flexibly on all pipes. This is especially practical if old pipes have to be joined to new pipes for structural alteration or renovation work.

Tool-free maintenance

With the quick-fastening, single-hand closure system with lift function, the cover is particularly easy to open and close – for convenient maintenance, with absolutely no tools required.

Twin flap backwater valve *Staufix*

Installation in a concrete slab / floor

CE EN 13564 Type 2

Made of polymer, with telescopic upper section for continuous height- and level adjustment.

For installation depth (D)

Ø 90 – 110, 276 – 399 mm

Ø 125 – 200, 328 – 450 mm,

Installation area 750 × 750 mm

With surface water tight cover plate class A 15 made of polymer.

Installation kit with choice of cover.

Backwater valve according to EN 13564 Type 2 with two self-closing flaps, one of which can be locked by hand as an emergency closure.

➔ **Accessories:** see page 36

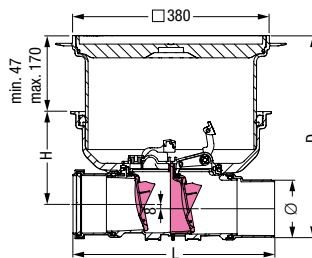

Without rodent protection (two polymer flaps)

Outer diameter Ø (mm)	L × H in mm	Art. no.
With recessed cover for on-site tiling		
Ø 90	389 × 179	730 090.10X
Ø 110	389 × 179	730 100.10X
Ø 125	515 × 222	730 125.10X
Ø 160	526 × 205	730 150.10X
Ø 200*	590 × 185	730 200.10X

With black cover

Ø 90	389 × 179	730 090.10S
Ø 110	389 × 179	730 100.10S
Ø 125	515 × 222	730 125.10S
Ø 160	526 × 205	730 150.10S
Ø 200*	590 × 185	730 200.10S

With rodent protection (one polymer and one stainless steel flap)

Outer diameter Ø (mm)	L × H in mm	Art. no.
With recessed cover for on-site tiling		
Ø 90	389 × 179	730 090.10XR
Ø 110	389 × 179	730 100.10XR
Ø 125	515 × 222	730 125.10XR
Ø 160	526 × 205	730 150.10XR
Ø 200*	590 × 185	730 200.10XR

With black cover

Ø 90	389 × 179	730 090.10SR
Ø 110	389 × 179	730 100.10SR
Ø 125	515 × 222	730 125.10SR
Ø 160	526 × 205	730 150.10SR
Ø 200*	590 × 185	730 200.10SR



* In-/Outlet Ø 200, hydraulics corresponds to Ø 160

Twin flap backwater valve *Staufix*

Installation in an exposed wastewater pipe

CE EN 13564 Type 2

Made of polymer. Backwater valve according to EN 13564 Type 2 with two self-closing flaps, one of which can be locked by hand as an emergency closure.

➤ Accessories: see page 36

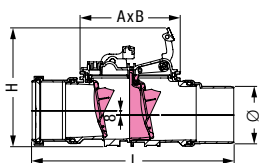

Without rodent protection (two polymer flaps)

Outer diameter Ø (mm)	L × H in mm	A × B in mm	Art. no.
Ø 90	386 × 230	193 × 167	730 090
Ø 110	389 × 230	193 × 167	730 100
Ø 125	515 × 306	263 × 214	730 125
Ø 160	526 × 306	263 × 214	730 150
Ø 200*	590 × 306	263 × 214	730 200

With rodent protection (one polymer and one stainless steel flap)

Outer diameter Ø (mm)	L × H in mm	A × B in mm	Art. no.
Ø 90	386 × 230	193 × 167	730 090R
Ø 110	389 × 230	193 × 167	730 100R
Ø 125	515 × 306	263 × 214	730 125R
Ø 160	526 × 306	263 × 214	730 150R
Ø 200*	590 × 306	263 × 214	730 200R



* In-/Outlet Ø 200, hydraulics corresponds to Ø 160

Single flap backwater valve *Staufix*

Installation in a concrete slab / floor



CE EN 13564 Type 1

Made of polymer, with telescopic upper section for continuous height- and level adjustment.

For installation depth (D)

Ø 90 – 110, 276 – 399 mm

Ø 125 – 200, 328 – 450 mm,

Installation area 750 × 750 mm

With surface water tight cover plate class A 15 made of polymer.

Installation kit with choice of cover.

Backwater valve according to EN 13564 Type 1

with one self-closing flap, can be locked by hand as an emergency closure.

Note: Can be upgraded to *Staufix* Type 2.

➤ **Accessories:** see page 36



Outer diameter Ø (mm)	L × H in mm	Art. no.
--------------------------	-------------	----------

With recessed cover for on-site tiling

Ø 90	389 × 179	720 090.10X
Ø 110	389 × 179	720 100.10X
Ø 125	515 × 222	720 125.10X
Ø 160	526 × 205	720 150.10X
Ø 200*	590 × 185	720 200.10X

With black cover

Ø 90	389 × 179	720 090.10S
Ø 110	389 × 179	720 100.10S
Ø 125	515 × 222	720 125.10S
Ø 160	526 × 205	720 150.10S
Ø 200*	590 × 185	720 200.10S

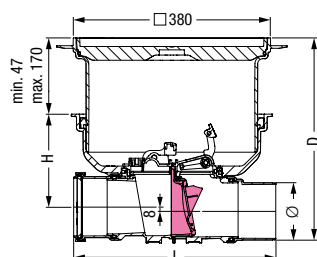

* In-/Outlet Ø 200, hydraulics corresponds to Ø 160

Single flap backwater valve *Staufix*

Installation in an exposed wastewater pipe



CE EN 13564 Type 1

Made of polymer

Backwater valve according to EN 13564 Type 1

with one self-closing flap, can be locked by hand as an emergency closure.

Note: Can be upgraded to *Staufix* Type 2.

➤ **Accessories:** see page 36



Outer diameter Ø (mm)	L × H in mm	A × B in mm	Art. no.
--------------------------	-------------	-------------	----------

Ø 90	386 × 230	193 × 167	720 090
Ø 110	389 × 230	193 × 167	720 100
Ø 125	515 × 306	263 × 214	720 125
Ø 160	526 × 306	263 × 214	720 150
Ø 200*	590 × 306	263 × 214	720 200

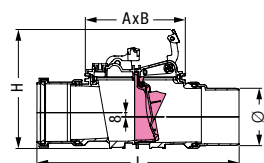

* In-/Outlet Ø 200, hydraulics corresponds to Ø 160

Clean out *Staufix*

Installation in a concrete slab / floor



Made of polymer, with telescopic upper section for continuous height- and level adjustment.

For installation depth (D)

Ø 90 – 110, 276 – 399 mm

Ø 125 – 200, 328 – 450 mm,

Installation area 750 × 750 mm

With surface water tight cover plate class A 15 made of polymer.

Installation kit with choice of cover.



➤ **Accessories:** see page 36

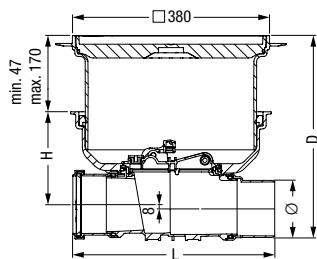

Outer diameter

Ø (mm) L × H in mm Art. no.

With recessed cover for on-site tiling

Ø 90	389 × 179	700 090.10X
Ø 110	389 × 179	700 100.10X
Ø 125	515 × 222	700 125.10X
Ø 160	526 × 205	700 150.10X
Ø 200*	590 × 185	700 200.10X

With black cover

Ø 90	389 × 179	700 090.10S
Ø 110	389 × 179	700 100.10S
Ø 125	515 × 222	700 125.10S
Ø 160	526 × 205	700 150.10S
Ø 200*	590 × 185	700 200.10S

* In-/Outlet Ø 200, hydraulics corresponds to Ø 160

Clean out *Staufix*

Installation in an exposed wastewater pipe



Made of polymer

➤ **Accessories:** see page 36

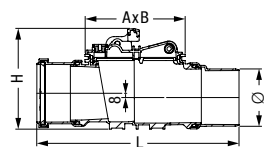

Outer diameter
Ø (mm) L × H A × B Art. no.
in mm in mm

Ø 90	386 × 230	193 × 167	700 090
Ø 110	389 × 230	193 × 167	700 100
Ø 125	515 × 306	263 × 214	700 125
Ø 160	526 × 306	263 × 214	700 150
Ø 200*	590 × 306	263 × 214	700 200

* In-/Outlet Ø 200, hydraulics corresponds to Ø 160



Backwater valves

Staufix Basic

The original solution for dry basements.

The original backwater valve *Staufix Basic* has been the standard in the water drainage sector for over 40 years. It is made entirely of polymer and so is completely corrosion-free. The *Staufix Basic* is installed in an individual drainage pipe and prevents the penetration of water and rodents by means of mechanical flaps – simple and secure!

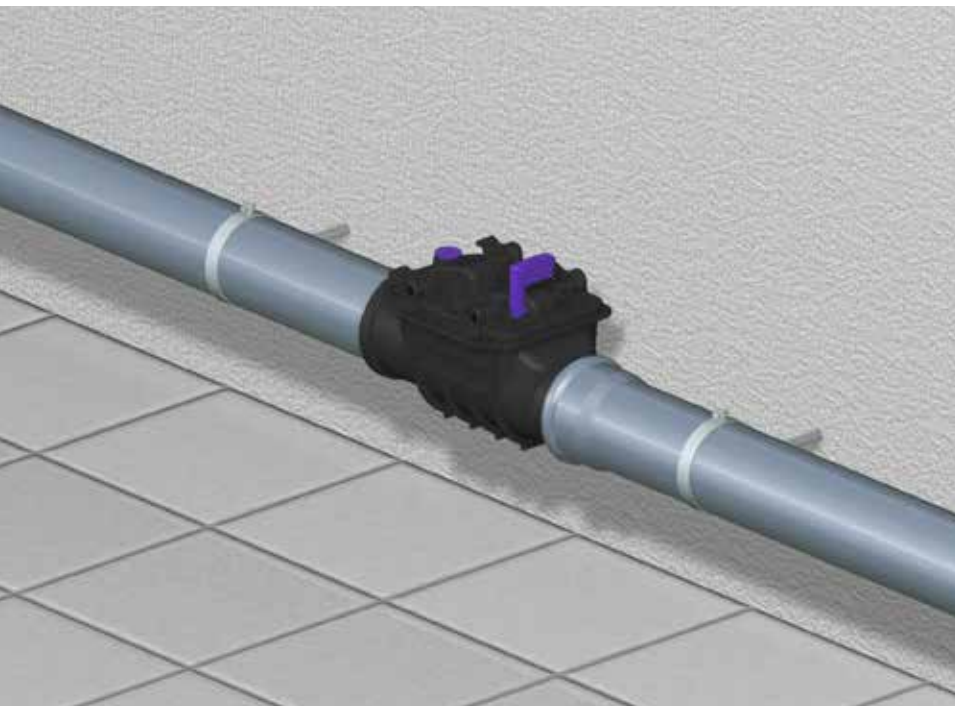

Low drop

Thanks to the minimal height difference of just 7 mm between the inlet and outlet, the backwater valve is ideally suited to installation in existing drainage pipes.

Cleaning & maintenance without tools

The cover can be opened or locked by hand thus providing access without the need for tools.

Rat protection

The optional stainless steel rat protection flap prevents rats and other vermin entering the premises.

Staufix Basic

Article numbers • Data sheets
Accessories • Spareparts
Videos • Download • BIM



www.kessel.com/staufix-basic



Twin flap backwater valve *Staufix Basic*

Installation in an exposed wastewater pipe



EN 13564 Type 2

Made of polymer. Installation area 650 × 300 mm. Twin flaps, self-closing, one of which can be locked by hand as an emergency closure. Inlet/outlet for connection to PVC pipe according to EN 1566-1.

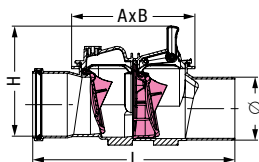

Without rodent protection (two polymer flaps)

Outer diameter Ø (mm)	L × H in mm	A × B in mm	Art. no.
Ø 110	355 × 180 + 25	205 × 155	73 100
Ø 125	405 × 240 + 40	270 × 200	73 125
Ø 160	450 × 240 + 40	270 × 200	73 150
Ø 200	530 × 278 + 50	353 × 248	73 200

With rodent protection (one polymer and one stainless steel flap)

Outer diameter Ø (mm)	L × H in mm	A × B in mm	Art. no.
Ø 110	355 × 180 + 25	205 × 155	73 100R
Ø 125	405 × 240 + 40	270 × 200	73 125R
Ø 160	450 × 240 + 40	270 × 200	73 150R



Single flap backwater valve *Staufix Basic*

Installation in an exposed wastewater pipe



EN 13564 Type 1

Made of polymer. Installation area 650 × 300 mm. Self-closing flap, can be locked by hand as an emergency closure. Inlet/outlet for connection to PVC pipe according to EN 1566-1.

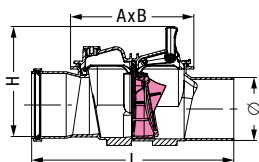

Without rodent protection (one polymer flap)

Outer diameter Ø (mm)	L × H in mm	A × B in mm	Art. no.
Ø 100	355 × 180 + 25	205 × 155	72 100
Ø 110	355 × 180 + 25	205 × 155	72 100
Ø 125	405 × 240 + 40	270 × 200	72 125
Ø 160	450 × 240 + 40	270 × 200	72 150
Ø 200	530 × 278 + 50	353 × 248	72 200

With rodent protection (one stainless steel flap)

Outer diameter Ø (mm)	L × H in mm	A × B in mm	Art. no.
Ø 110	355 × 180 + 25	205 × 155	72 100R
Ø 125	405 × 240 + 40	270 × 200	72 125R
Ø 160	450 × 240 + 40	270 × 200	72 150R



Single flap backwater valve *Staufix Basic*

Installation in an exposed wastewater pipe



EN 13564 Type 0

Made of polymer. Installation area 650 × 300 mm, Self-closing flap. Inlet/outlet for connection to PVC pipe according to EN 1566-1.

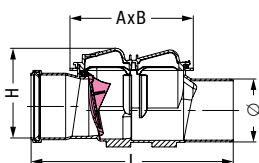

Outer diameter Ø (mm)	L × H in mm	A × B in mm	Art. no.
Ø 100	355 × 170	205 × 155	76 100
Ø 110	355 × 170	205 × 155	71 100
Ø 125	405 × 230	270 × 200	71 125
Ø 160	450 × 230	270 × 200	71 150
Ø 200	530 × 278	353 × 248	71 200

↗ Conversion kits: page 44
↗ Accessories: pages 54 – 57



Clean out *Staufix Basic*

Installation in an exposed wastewater pipe

Made of polymer.
Installation area 650 × 300 mm
Upgradable to all *Staufix* model
backwater valves

- Conversion kits: see below
- Accessories: pages 54 – 57

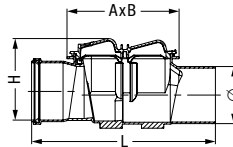



Outer diameter Ø (mm)	L × H in mm	A × B in mm	Art. no.
Ø 110	355 × 170	205 × 155	70 100
Ø 125	405 × 230	270 × 200	70 125
Ø 160	450 × 230	270 × 200	70 150
Ø 200	530 × 278	353 × 248	70 200



Conversion kits

for *Staufix Basic* from 04/2005

		Outer diameter Ø (mm)	Art. no.	
for upgrade to Type 2 (Twin flap backwater valve <i>Staufix</i>)	Function: The <i>Staufix Basic</i> clean out body can be converted to a <i>Staufix Basic</i> twin flap backwater valve by means of two backwater flaps, the insert flap housing and the lockable cover.		Ø 110	70 231
			Ø 125	70 232
			Ø 160	70 232
			Ø 200	70 205
for upgrade to Type 1 (Single flap backwater valve <i>Staufix</i>)	Function: The <i>Staufix Basic</i> clean out body can be converted to a <i>Staufix Basic</i> single flap backwater valve with emergency closure by means of the backwater flap, insert flap housing and the lockable cover.		Ø 110	70 241
			Ø 125	70 242
			Ø 160	70 242
			Ø 200	70 205
for upgrade to Type 0 (Single flap backwater valve <i>Staufix</i>)	Function: The <i>Staufix Basic</i> clean out body can be converted to a <i>Staufix Basic</i> single flap backwater valve by means of a backwater flap (for <i>Staufix Basic</i> from 04/2005).		Ø 110	70 261
			Ø 125	70 262
			Ø 160	70 262
			Ø 200	70 203

Backwater valve *Staufix* Ø 50 or Ø 75

Standard-compliant in nominal widths
Ø 50 or Ø 75.

Individual drainage points such as washbasins, showers or washing machines can be very simply protected against backwater with the *Staufix* Ø 50 or *Staufix* Ø 75 backwater valves.

The *Staufix* Ø 50 or Ø 75 can be installed in the pipe to protect several drainage points. There are also additional variants of the *Staufix* Ø 50 with siphon traps, with washing machine connections or with inlet funnel for the emergency overflow of heating systems. This ensures that individual drainage points are protected.



Ø 50 or Ø 75 exposed drainage pipe



Washbasins with odour traps and washing machine connection



Twin flap backwater valve with inlet funnel for emergency overflow of heating system

Staufix Ø 50 or Ø 75

Article numbers • Data sheets
Accessories • Spareparts
Videos • Download • BIM



www.kessel.com/staufix-50-75



Standard-compliant

The small backwater valves *Staufix* Ø 50 and *Staufix* Ø 75 are each equipped with two flaps and an emergency closure – and the first standard-compliant backwater double valves for wastewater without sewage per EN 13564 Type 2.

Area of application

The backwater valves are versatile in use: They can be installed as individual safeguards for washbasins, showers or washing machines, as a central backwater protection in horizontal drainage pipes or as an emergency overflow for heating systems.

Tool-free maintenance

The maintenance and cleaning of the backwater valves is particularly convenient and possible without any tools whatsoever thanks to the quick-release closure.

Twin flap backwater valve *Staufix* Ø 50

Installation in an exposed wastewater pipe



CE EN 13564 Type 2

Made of polymer.

Twin flaps, self-closing, one of which can be locked by hand as an emergency closure.

Inlet/outlet for connection to HT-pipe according to EN 1451-1.

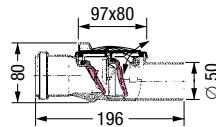

Outer diameter
Ø (mm)

Art. no.

Ø 50

73 050



Twin flap backwater valve *Staufix* Ø 75

Installation in an exposed wastewater pipe



CE EN 13564 Type 2

Made of polymer.

Twin flaps, self-closing, one of which can be locked by hand as an emergency closure.

Inlet/outlet for connection to HT-pipe according to EN 1451-1.

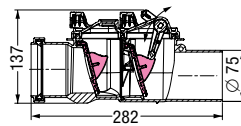

Outer diameter
Ø (mm)

Art. no.

Ø 75

73 070



Twin flap backwater valve *Staufix Siphon* Ø 50

Installation in an exposed wastewater pipe



CE EN 13564 Type 5

Made of polymer.

Twin flaps, self-closing, one of which can be locked by hand as an emergency closure, incl. wall attachment, inlet connection Ø 40 (1 1/2 inch) at pipe odour trap. Outlet Ø 50 for connection to HT-pipe according to EN 1451-1.

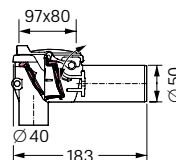

Outer diameter Ø (mm)	Art. no.
Ø 50	73 051

Twin flap backwater valve *Staufix Siphon* Ø 50

Installation in an exposed wastewater pipe



CE EN 13564 Type 5

Made of polymer.

Twin flaps, self-closing, one of which can be locked by hand as an emergency closure, incl. wall attachment, outlet Ø 50 for connection to HT-pipe according to EN 1451-1.

Model contains:

- pipe odour trap
- washing machine connection

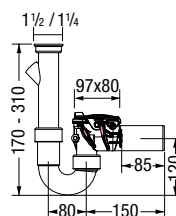

Outer diameter Ø (mm)	Art. no.
Ø 50	73 052

Twin flap backwater valve *Staufix Siphon* Ø 50

Installation in an exposed wastewater pipe



CE EN 13564 Type 5

Made of polymer.

Two flaps, self-closing, one of which can be locked by hand as an emergency closure, incl. wall attachment. Outlet Ø 50 for connection to an HT-pipe according to EN 1451-1.

Model contains:

- pipe odour trap
- inlet funnel

Installation: Ideal for the emergency overflow of heating systems

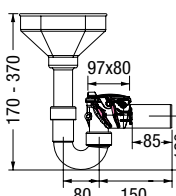

Outer diameter Ø (mm)	Art. no.
Ø 50	73 053



Backwater valve *Multitube*

The high-performance solution for larger pipes.

The *Multitube* is a powerful backwater valve for large-diameter pipes in public, municipal and industrial areas. It can be installed in an exposed drainage pipe. The *Multitube* is also completely corrosion free as it is made entirely from polymer. Available in diameters of Ø 260 mm to Ø 515 mm.

Area of application

The *Multitube* backwater valve is suitable for use in leaching and pond systems and behind cisterns that are separately connected to a rainwater channel or that lead to a drainage ditch. It provides not only reliable protection against backwater, but also provides additional protection against rats, mice, frogs and vermin.

Multitube
 Article numbers • Data sheets
 Accessories • Spareparts
 Videos • Download • BIM

www.kessel.com/multitube



Single flap backwater valve *Multitube*

Installation in an exposed wastewater pipe



Made of polymer,
 One self-closing flap,
 incl. two connection couplings



Illustration shows Art. no. 71 400

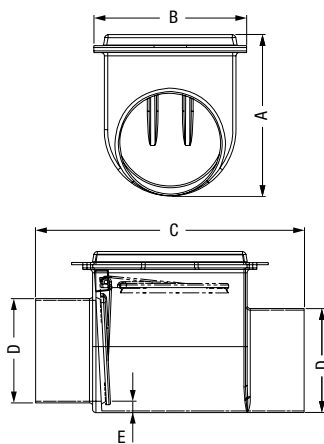

Outer diameter Ø (mm)	A in mm	B in mm	C in mm	D in mm	E in mm	Connection for pipe size Ø mm	Art. no.
With connection couplings*, for connection to all pipe materials							
Ø 260	485	455	730	260	60	250 - 275	71 250
Ø 320	490	470	825	320	35	310 - 335	71 300
Ø 410	600	610	900	410	30	385 - 410	71 400
Ø 515	730	700	1230	515	40	495 - 525	71 500

* With connection couplings it is possible to connect pipes of different diameters. Connection couplings are necessary where the difference in outer diameter is > 12 mm. Rights reserved for technical changes

Backwater valve Pipe flap valve

The dependable solution for open end drainage pipes.

The self-actuating pipe flap valves prevent undesirable backwash into wastewater pipes in the event of backwater or high water levels. They are made entirely of polymer and so are 100 % corrosion-free. The pipe flap valves are available in various sizes from Ø 110 mm to Ø 1.000 mm.

Area of application

Pipe flap valves are used in wastewater without sewage, for example in seawater and freshwater environments. Here they serve as a backwater valve in horizontal pipes leading into chambers or outdoors.

Pipe flap valve

for connection to open end drainage pipes

Flap self-closing. Inlet/outlet for connection to PVC pipe according to EN 1451-1. KESSEL-Pipe Flap, manufactured from polymer, with free hanging self activating backwater flap. For connection to open end of pipe, gasketed inlet for push-fit connection to PVC drainage piping according to DIN 19534 and PE-HD piping according to DIN 19537.

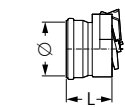

Illustration shows Ø 110 – Ø 200

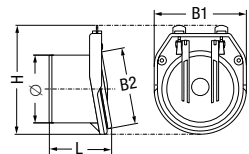

Illustration shows Ø 250 – Ø 638

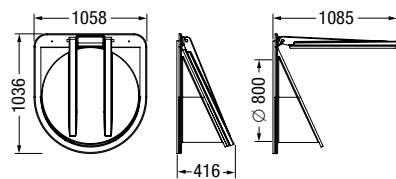

Illustration shows Ø 800

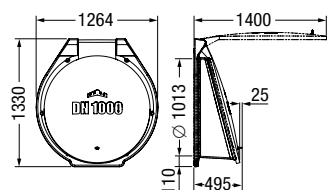

Illustration shows Ø 1000

Pipe flap valve

Article numbers • Data sheets
Accessories • Spareparts
Videos • Download • BIM

www.kessel.com/pipe-flap



Illustration shows Ø 160



Illustration shows Ø 250



Illustration shows Ø 800

Outer diameter Ø (mm)	DN in mm	H in mm	L in mm	B1 in mm	B2 in mm	Connection for pipe size Ø mm	Art. no.
Ø 110	-	-	120	-	-	-	79 100
Ø 125	-	-	136	-	-	-	79 125
Ø 160	-	-	142	-	-	-	79 150
Ø 200	-	-	170	-	-	-	79 200

Without connection coupling, connection according to EN 1451-1

Outer diameter Ø (mm)	DN in mm	H in mm	L in mm	B1 in mm	B2 in mm	Connection for pipe size Ø mm	Art. no.
Ø 250	250	400	220	345	280	-	79 250
Ø 315	315	450	225	400	410	-	79 300

With connection coupling*, for connection to all pipe materials

Outer diameter Ø (mm)	DN in mm	H in mm	L in mm	B1 in mm	B2 in mm	Connection for pipe size Ø mm	Art. no.
Ø 405	400	420	295	417	-	385 - 410	79 400
Ø 506	500	500	320	522	-	495 - 525	79 500
Ø 638	600	659	345	655	-	605 - 638	79 600
Ø 800**	-	-	-	-	-	-	79 800
Ø 1000**	-	-	-	-	-	-	79 1000





* With connection couplings it is possible to connect pipes of different diameters. Connection couplings are necessary where the difference in outer diameter is > 12 mm. Rights reserved for technical changes

** For wall installation

Accessories

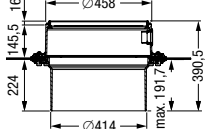

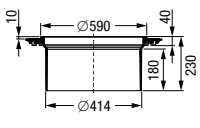
Pumpfix F, Staufix FKA, Staufix SWA and Controlfix

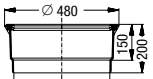
Extension sections

			Art. no.
with centre flange	<p>Compatibility: For installation in a concrete floor <i>Pumpfix F, Staufix FKA, Staufix SWA and Controlfix</i></p> <p>Additional function: For installation in water-proof concrete</p> <p>Inclusive: Temporary construction debris cover, fully assembled, gasket set (counter flange made of polymer, screwed, elastomer sealing sheet made of NK/SBR Ø 800 mm)</p> <p>Extension: Max. 360 mm</p>	 	83 075
with flange and counter flange	<p>Compatibility: For installation in a concrete floor <i>Pumpfix F, Staufix FKA, Staufix SWA and Controlfix</i></p> <p>Additional function: For connection to an on-site sealing sheet</p> <p>Inclusive: Screws</p> <p>Extension: Max. 140 mm (In case of deeper installation ensure maintenance capability!)</p>	 	83 073
with gasket	<p>Compatibility: For installation in a concrete floor <i>Pumpfix F, Staufix FKA, Staufix SWA and Controlfix</i></p> <p>Extension: Max. 180 mm (In case of deeper installation ensure maintenance capability!)</p>	 	83 070

Cable extensions



for extension from 15 m or 25 m (cable length delivered: 5 m)

	for backwater pumping station <i>Pumpfix F</i>	for motorized backwater valve <i>Staufix FKA and Staufix FKA Standard (up to 2015)</i>		Art. no.
Cable extension for motor (10 m)	<p>Extension to 15 m: 1×80 890</p> <p>Extension to 25 m: 2×80 890</p>	<p>Extension to 15 m: 1×80 890</p> <p>Extension to 25 m: 2×80 890</p>		80 890
Cable extension for probe (10 m)	<p>Extension to 15 m: 2×80 889</p> <p>Extension to 25 m: 4×80 889</p>	<p>Extension to 15 m: 1×80 889</p> <p>Extension to 25 m: 2×80 889</p>		80 889
Cable extension for pump (10 m)	<p>Extension to 15 m: 1×80 891</p> <p>Extension to 25 m: 2×80 891</p>			80 891

Cover plates

			Cover	Art. no.
surface water tight	<p>Compatibility: For installation in a concrete floor <i>Pumpfix F, Staufix FKA, Staufix SWA and Controlfix</i></p> <p>Inclusive: Gasket</p> <p>Version recessed for on-site tiling, grey: For tile thicknesses of 18 mm (Ventilation always required when in use!)</p>	 	<p>tileable</p> <p>black</p>	<p>830 052</p> <p>830 050</p>

Spigot and Socket



			Outer diameter Ø (mm)	Art. no.
Spigot	<p>Compatibility: For backwater valves <i>Pumpfix F, Staufix FKA, Staufix SWA and Controlfix</i></p> <p>Function: Removable inlets / outlets</p>		<p>Ø 110</p> <p>Ø 125</p> <p>Ø 160</p> <p>Ø 200*</p>	<p>83 081</p> <p>83 082</p> <p>83 083</p> <p>83 084</p>
Socket	<p>Compatibility: For backwater valves <i>Pumpfix F, Staufix FKA, Staufix SWA and Controlfix</i></p> <p>Function: Removable inlets / outlets</p>		<p>Ø 110</p> <p>Ø 125</p> <p>Ø 160</p> <p>Ø 200*</p>	<p>83 085</p> <p>83 086</p> <p>83 087</p> <p>83 088</p>

* In-/Outlet Ø 200, hydraulics corresponds to Ø 160

Accessories

Pumpfix F, Staufix FKA, Staufix SWA and Controlfix

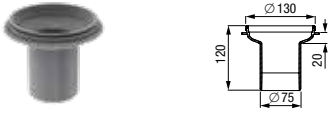
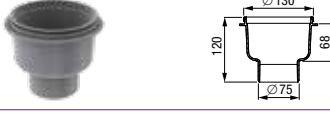
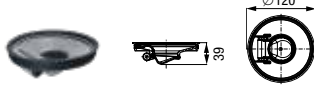
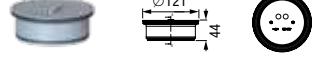
Hygiene and odour stop

			Cover	Art. no.
Drain body	Compatibility: For lowest installation; for backwater pumping station <i>Pumpfix F</i>		black grey	680 796 680 798
Drain body	Compatibility: Seal water height 50 mm; for backwater pumping station <i>Pumpfix F</i>		black grey	680 795 680 797
additionally Multistop	Compatibility: For backwater pumping station <i>Pumpfix F</i> Function: Odour, foam, rodent and insect stop			48 500
additionally Megastop	Compatibility: For backwater pumping station <i>Pumpfix F</i> Function: Mechanical odour trap inclusive hair filter for KESSEL upper sections			48 550
additionally odour trap	Compatibility: For backwater pumping station <i>Pumpfix F</i> Seal water height: 50 mm (Ventilation always required when in use!)			680 696

Hygiene

			Art. no.
Hair filter	Compatibility: Art. no. 48 500; for backwater pumping station <i>Pumpfix F</i>		48 700

Rodent / Insect protection



for Staufix FKA and Staufix SWA

			Art. no.
Rat protection flap	Compatibility: <i>Staufix FKA</i> from 01/2011 to 2015 (with flap in pendulum position) Inclusive: Stainless steel shield		80 037

Maintenance

			Art. no.
Testing funnel	Compatibility: For all <i>Staufix FKA</i> and <i>Staufix SWA</i> backwater valves (Ø 110, Ø 125, Ø 160) Inclusive: Gasket		70 214

Control unit accessories

			Art. no.
Audible alarm	Compatibility: For all control units with SDS function Cable length: 20 m		20 162
Potential-free contact	Compatibility: For all control units up to 12/2016 with SDS function		80 072
Activation code for potential-free contact	Compatibility: For Comfort control units beginning model year 2017		80 077

Accessories

Staufix

Extension sections

made of polymer

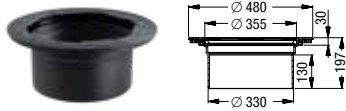

with flange

for deeper installation

Inclusive: Sealing

Extension: Max. 147 mm

Note: In case of deeper installation ensure maintenance capability!

Art. no. 830 070

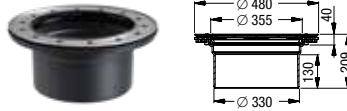

with flange and counter flange

for deeper installation

Material: Counter flange made of stainless steel

Inclusive: Sealing

Extension: Max. 147 mm

Compatibility: For connection to an on-site membrane

Note: In case of deeper installation ensure maintenance capability!

Art. no. 830 073

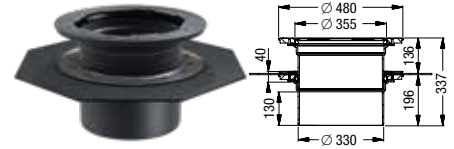

with flange

for installation in waterproof concrete

Inclusive sealing set:

Elastomer waterproofing membrane made of NK/SBR Ø 700 mm

Extension: Max. 294 mm

Delivery: Completely assembled.

Note: Suitable for installation in the concrete slab/floor.

Art. no. 830 075

Spigot / Socket

made of polymer



Spigot

removable fitting mountable on both sides and in different dimensions

Outer diameter Ø (mm)	Art. no.
Ø 90	83 090
Ø 100	830 200
Ø 110	830 100
Ø 125	83 082
Ø 160	83 083
Ø 200	83 084



Socket

removable fitting mountable on both sides and in different dimensions

Outer diameter Ø (mm)	Art. no.
Ø 90	83 091
Ø 100	830 202
Ø 110	830 101
Ø 125	83 086
Ø 160	83 087
Ø 200	83 084

Conversion kits

Rodent protection flap

Compatibility: Art. no. 70 100, 70 125, 70 150, 71 100, 71 125, 71 150, 72 100, 72 125, 72 150, 73 100, 73 125, 73 150, 720 ..., 730 ...

Material: Made of stainless steel



Outer diameter
Ø (mm)

Art. no.

Ø 90 - Ø 110

70 233

Ø 125 - Ø 200

70 234

Backwater flap

Compatibility: For upgrade from type 1 to type 2



Ø 90 - Ø 110

70 231

Ø 125 - Ø 200

70 232

Standard backwater chamber or modular backwater chamber Ø 1000 with *Controlfix* clean out

The robust solution in front of the building

A backwater chamber in front of the building offers significant advantages. It enables all drainage points that are at risk of backwater to be safeguarded outside the building at a single central and maintenance-friendly point. Noise nuisance, for example due to pumps or similar, can be ruled out and there is no lost space inside the building.

Double use

The backwater chamber can simultaneously be used as a transition chamber – with two side inlets for the drainage of the building, roof and yard.



Thanks to the clean out *Controlfix*, the backwater chambers can be equipped with various conversion kits:

- Conversion kit *Staufix SWA*: page 21
- Conversion kit *Staufix FKA*: page 21
- Conversion kit *Pumpfix F*: page 21

Standard backwater chamber Ø 1000 with *Controlfix*

Thanks to its monolithic construction using unbreakable, impact-resistant material, the standard backwater chamber Ø 1000 is permanently leak-proof and secure against the ingress of roots. In addition, it can also be ideally adapted to the ground level thanks to its vertically, adjustable upper section.

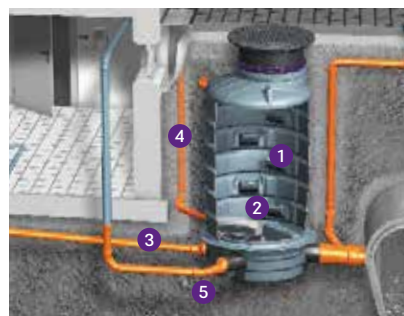

- 1 Backwater chamber
- 2 Clean out
- 3 Basement drains
- 4 Roof drains
- 5 Basement drainage

Modular backwater chamber Ø 1000 with *Controlfix*

Thanks to its modular construction with a technical module as well as a large selection of chamber modules and upper sections, the modular backwater chamber can be adapted to suit any individual installation situation. Ground water resistance up to a depth of 3.000 mm



- 1 System base
- 2 Clean out
- 3 System chamber
- 4 Height adjustable upper section

Backwater chambers

Article numbers • Data sheets
Accessories • Spareparts
Videos • Download • BIM

➤ [www.kessel.com/
backwater-chambers](http://www.kessel.com/backwater-chambers)



Backwater inspection chamber Ø 1000 with *Controlfix*

For underground installation



Z-42.1-333

Polyethylene PE-HD.
Monolithic design, with open continuous channel and clean out *Controlfix*, with integrated access steps, watertight, resistant to aggressive wastewater, with telescopic height-adjustable protective cover made of polymer for use during the construction period (can be used as a cover in green areas).

Triple 160 mm hub type gasketed inlets (left and right inlets with open channel passage through chamber, center hub inlet connected to housing for insertion of KESSEL backwater valve). Available backwater valve options - KESSEL *Staufix SWA*, KESSEL *Staufix FKA* or KESSEL *Pumpfix F*.

For connection to PVC pipe according to EN 1401-1 and PE-HD connections according to EN 12666-1.

Installation:

Handles groundwater depths up to 2.000 mm

Distance from base of chamber to:

Base of inlet approx. 136 mm

Base of outlet approx. 108 mm

Note: Further chamber heights (on request)

➤ **Conversion kits:** see page below

➤ Accessories:

- page 44
- Depending on installation depth, entrance access steps may be required (see page 45)



Installation depth in mm

Art. no.

3 inlets Ø 160 / 1 outlet Ø 200

H1: 1180	88 10 05
H2: 1680	88 15 05
H3: 2180	88 20 05
H4: 2680	88 25 05
H5: 3180	88 30 05

3 inlets Ø 160 / 1 outlet Ø 160

H1: 1180	88 10 05-DN 150
H2: 1680	88 15 05-DN 150
H3: 2180	88 20 05-DN 150
H4: 2680	88 25 05-DN 150
H5: 3180	88 30 05-DN 150

Standard cover on-site



Accessories Art. no. 86 01 22 / 86 01 16



Inspection chamber including temporary construction debris cover

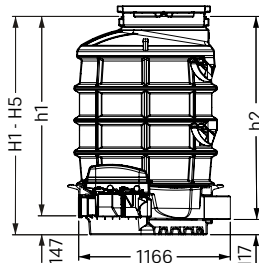

Height	h1	h2
H1	1046	1072
H2	1528	1558
H3	2028	2058
H4	2533	2563
H5	3033	3063

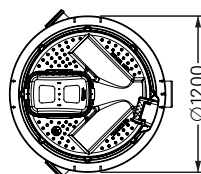

Conversion kits

for models made on or after Jan 2011

Art. no.

Backwater pumping *Pumpfix F*

Compatibility: Engineering systems base backwater chamber Ø 1000, for Ø 110 - Ø 200*
Inclusive: Komfort control unit
Cable length: 15 m
➤ Cable extension: page 36



80 102

Motorized backwater valve *Staufix FKA*

Compatibility: Engineering systems base backwater chamber Ø 1000, for Ø 110 - Ø 200*
Inclusive: Komfort control unit
Cable length: 15 m
➤ Cable extension: page 36



80 104

Backwater valve *Staufix SWA*

Compatibility: Engineering systems base backwater chamber Ø 1000, for Ø 110 - Ø 200*



80 091



* In-/Outlet Ø 200, hydraulics corresponds to Ø 160

Engineering systems base backwater chamber with *Controlfix*



For installation in a concrete slab or outdoor underground installation

Polyethylene PE-HD

Version:

- integrated clean out *Controlfix*
- closed channel passage or two inlets in direction of flow

Installation:

Handles groundwater depths up to 3.000 mm

- **Installation:** in combination with system chamber page 42
- **Conversion kits:** see page below
- **Accessories:** pages 44



With closed channel passage

Outer diameter Ø (mm)	Art. no.
Ø 110	85 10 01
Ø 125	85 12 51
Ø 160	85 15 01

With two inlets 90° in flow direction

Outer diameter Ø (mm)	Art. no.
Ø 110	85 10 03
Ø 125	85 12 53
Ø 160	85 15 02

Engineering systems base backwater chamber in combination with system chamber Ø 1000

Conversion options

- Conversion kit *Staufix SWA*
- Conversion kit *Staufix FKA*
- Conversion kit *Pumpfix F*

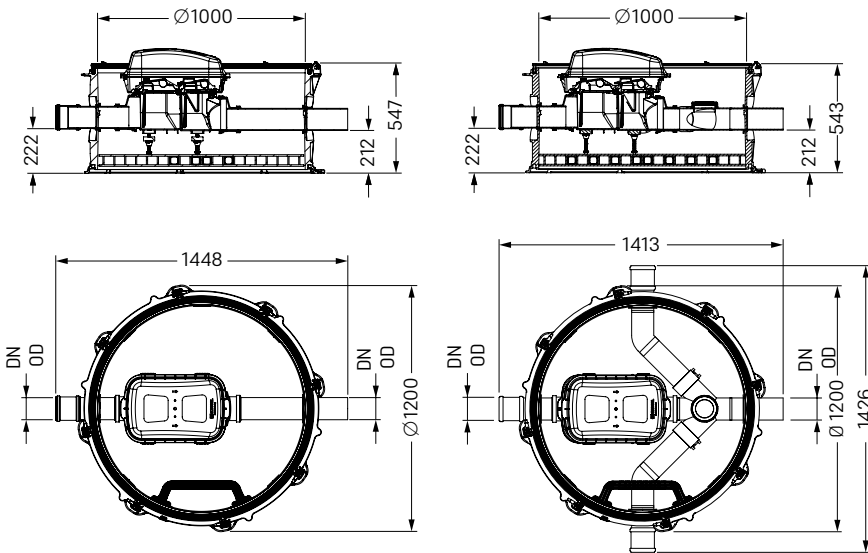

Channel passage:

with closed channel passage Ø...

Version Ø 200: (on request)

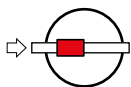

with two inlets in direction of flow Ø...

left + right 90°

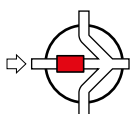

Conversion kits

for models made on or after Jan 2011

		Art. no.
Backwater pumping <i>Pumpfix F</i>	<p>Compatibility: Engineering systems base backwater chamber Ø 1000, for Ø 110 - Ø 200*</p> <p>Inclusive: Komfort control unit</p> <p>Cable length: 15 m</p> <p>➤ Cable extension: page 36</p>	80 102
Motorized backwater valve <i>Staufix FKA</i>	<p>Compatibility: Engineering systems base backwater chamber Ø 1000, for Ø 110 - Ø 200*</p> <p>Inclusive: Komfort control unit</p> <p>Cable length: 15 m</p> <p>➤ Cable extension: page 54</p>	80 104
Backwater valve <i>Staufix SWA</i>	<p>Compatibility: Engineering systems base backwater chamber Ø 1000, for Ø 110 - Ø 200*</p>	80 091

* In-/Outlet Ø 200, hydraulics corresponds to Ø 160

Engineering system chamber Ø 1000 with access opening Ø 600

for combination with engineering system base

EN 13598 Part 2 Z-42.1-527

Made of polyethylene PE-HD

Installation: For underground installation; handles groundwater depths up to 3000 mm

Modular design comprising:

- Chamber rings with access steps fitted
- With telescopic height adjustable upper section
- Round cover made of cast iron
- Includes all sealing gaskets and wedge connectors required for installation

Delivery: As individual elements

Remark: Covers surface water tight

Note: Additional installation depths (on request)

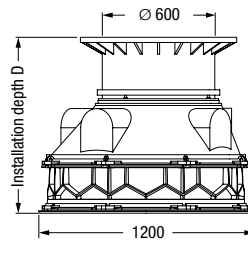

Installation depth D in mm	Art. no.
Class A/B	
1130 - 1379	874 00 18
1380 - 1629	874 00 24
1630 - 1879	874 00 30
1880 - 2129	874 00 36
2130 - 2379	874 00 42
2380 - 2629	874 00 48
2630 - 2879	874 00 54
2880 - 3129	874 00 60
Class D	
1130 - 1379	874 00 19
1380 - 1629	874 00 25
1630 - 1879	874 00 31
1880 - 2129	874 00 37
2130 - 2379	874 00 43
2380 - 2629	874 00 49
2630 - 2879	874 00 55
2880 - 3129	874 00 61

Engineering system chamber Ø 1000 with access opening Ø 800

for combination with engineering system base

EN 13598 Part 2 Z-42.1-527

Made of polyethylene PE-HD

Installation: For installation in the concrete slab; handles groundwater depths up to 3000 mm

Modular design comprising:

- For waterproof concrete with flange and counter flange
- Chamber rings with access steps fitted
- With telescopic height adjustable upper section
- Square cover made of stainless steel, class A/L 15 or round cover in class K 3
- Includes all sealing gaskets and wedge connectors required for installation

Delivery: As individual elements

Remark: Covers surface water tight

Note: Additional installation depths, upper sections and covers class B/D (on request)

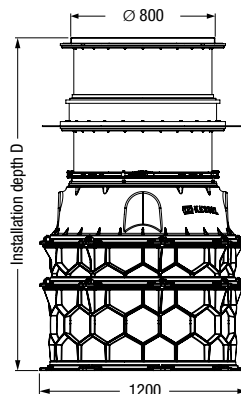

Cover tileable, square	
Installation depth D in mm	Art. no.
668 - 917	874 00 03
918 - 1167	874 00 09
1168 - 1417	874 00 15
1418 - 1667	874 00 21
1668 - 1917	874 00 27
Cover not tileable, square, anti-slip	
Installation depth D in mm	Art. no.
653 - 902	874 00 05
903 - 1152	874 00 11
1153 - 1402	874 00 17
1403 - 1652	874 00 23
1653 - 1902	874 00 29
Cover not tileable, round	
Installation depth D in mm	Art. no.
638 - 887	874 02 22
888 - 1137	874 02 23
1138 - 1387	874 02 24
1388 - 1637	874 02 25
1638 - 1887	874 02 26

Engineering system chamber Ø 1000 with access opening Ø 800

for combination with engineering system base

EN 13598 Part 2 Z-42.1-527

Made of polyethylene PE-HD

Installation: For underground installation; handles groundwater depths up to 3000 mm

Modular design comprising:

- Chamber rings with access steps fitted
- With telescopic height adjustable upper section
- Covers made of stainless steel
- Includes all sealing gaskets and wedge connectors required for installation

Delivery: As individual elements

Remark: Covers surface water tight

Note: Additional installation depths, upper sections and covers class B/D (on request)



Illustration shows Art. no. 874 01 43



Illustration shows Art. no. 874 00 20

Illustration shows Art. no. 874 01 22

Round cover

Installation depth D in mm Art. no.

Class K 3

375 - 624	874 01 22
625 - 874	874 01 23
875 - 1124	874 01 24
1125 - 1374	874 01 25
1375 - 1624	874 01 26
1625 - 1874	874 01 27
1875 - 2124	874 01 28
2125 - 2374	874 01 29
2375 - 2624	874 01 30
2625 - 2874	874 01 31
2875 - 3124	874 01 32

Square cover

Installation depth D in mm Art. no.

Class B

620 - 869	874 01 41
870 - 1119	874 01 42
1120 - 1369	874 01 43

Class D

620 - 869	874 01 58
870 - 1119	874 01 59
1120 - 1369	874 01 60

Square cover

Installation depth D in mm Art. no.

Class A/L 15, not tileable, anti-slip

396 - 645	874 00 04
646 - 895	874 00 10
896 - 1145	874 00 16
1146 - 1395	874 00 22
1396 - 1645	874 00 28
1646 - 1895	874 00 34
1896 - 2145	874 00 40
2146 - 2395	874 00 46
2396 - 2645	874 00 52
2646 - 2895	874 00 58
2896 - 3145	874 00 64

Class A/L 15, tileable

411 - 660	874 00 02
661 - 910	874 00 08
911 - 1160	874 00 14
1161 - 1410	874 00 20
1411 - 1660	874 00 26
1661 - 1910	874 00 32
1911 - 2160	874 00 38
2161 - 2410	874 00 44
2411 - 2660	874 00 50
2661 - 2910	874 00 56
2911 - 3160	874 00 62

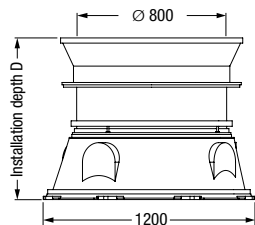

Illustration shows Art. no. 874 01 58

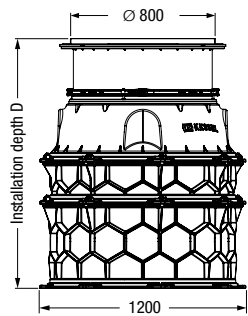





Illustration shows Art. no. 874 00 02

Accessories

Backwater chambers

Cover plates

			Cover	Art. no.
with ventilation	Compatibility: Backwater inspection chamber Ø 1000 Material: Class A, B in cast iron and concrete Class D in cast iron Inclusive: Lockable cover plates with <i>Lock & Lift</i> -function		Class A	860 134
			Class B	860 135
			Class D, <i>Lock & Lift</i>	860 164
surface water tight	Compatibility: Backwater inspection chamber Ø 1000 Material: In cast iron Inclusive: Lockable cover plates with <i>Lock & Lift</i> -function		Class A/B, <i>Lock & Lift</i>	860 161
			Class D, <i>Lock & Lift</i>	860 160
	Compatibility: Backwater inspection chamber Ø 1000 Material: In cast iron and concrete		Class A	860 130
			Class B	860 131

Upper sections

			Telescopic height adjustable	Art. no.
without recesses for a sludge bucket	Compatibility: Covers class A/B/D Inclusive: Clamping ring, with <i>Lock & Lift</i> function		65 - 579	860 152
			65 - 329	860 153
can be assembled with standard concrete rings	Compatibility: For standard bearing ring / concrete/cast covers, class A/B/D; for backwater inspection chamber Ø 1000		79 - 579	860 154
			79 - 329	860 155
			79 - 579	860 156

Extension section

			Art. no.
500 mm	Compatibility: Engineering systems base backwater chamber Inclusive: 2 access steps, installed Note: Without gasket and connecting wedges		680 371
250 mm	Compatibility: Engineering systems base backwater chamber Inclusive: 1 access step, installed Note: Without gasket and connecting wedges		680 370

Accessories

Backwater chambers

Gasket / Embedded step / Locking and removal key / Connection and attachment sets		Outer diameter Ø (mm)	Art. no.	
Lip gasket	Compatibility: Art. no. 860 152, 860 153, 860 154, 860 155	Ø 600	860 116	
Embedded step	Compatibility: Art. no. 860 152, 860 153, 860 154, 860 155 Inclusive: Drilling template, step, hand rail, screws Note: The embedded step can be fitted to the upper section (Art. no. 860 152, 860 153, 860 154, 860 155) in the factory at an additional charge		860 109	
Locking and removal key / Connection and attachment sets		Voltage	Art. no.	
Cable piping gasket set	Compatibility: Control unit 230 V and 400 V	in the building in the building	85 401 85 402	
		in the chamber in the chamber	85 403 85 404	
Locking and removal key	Compatibility: Chamber cover		915 595	
Set of connecting wedges	Compatibility: Art. no. 680 371 and 680 370 Set-content: 10 pieces		680 373	
Profiled gasket	Compatibility: Art. no. 680 371 and 680 370		680 125	
Cable attachment set	Compatibility: Engineering systems base backwater chamber Ø 1000 Set-content: 3 pieces of clamps		28 076	
Hole saw		Outer pipe diameter in mm	Drill size in mm	Art. no.
Hole saw set	Compatibility: Engineering systems base backwater chamber Ø 1000 Inclusive: Saw blade holder	Ø 50 Ø 75 Ø 110 Ø 110 Ø 125 Ø 160	60 92 121 121 133 168	500 101 500 100
Sealing		Nominal pipe diameter in mm	Outer pipe diameter in mm	Art. no.
Pipe sealing gasket	Compatibility: Engineering systems base backwater chamber Ø 1000 Drill size: Ø 50: 60 mm Ø 75: 92 mm Ø 110: 121 mm Ø 125: 133 mm Ø 160: 168 mm	DN 50 DN 70 DN 100 DN 125 DN 150	Ø 50 Ø 75 Ø 110 Ø 125 Ø 160	850 114 850 116 850 117 850 118 850 119

Backwater pumping station *Pumpfix S*

The Special solution with backwater valve and pump.

Stronger than the backwater: The *Pumpfix S* is the only basement drain with backwater valve, which pumps against backwater. It normally drains sewage free wastewater to the sewer by gravity – even handles incoming flood water or flooding from a burst water supply pipe. Yet it shows its true strength in case of backwater: The pump then switches on automatically and pumps the building's wastewater into the flooded sewer. It is also ideally suitable for draining outdoor basement stairs.

The *Pumpfix S* is available in two models: a compact version with polymer grating, which is particularly suitable for renovation projects, and a larger version with multiple inlet connections and a tileable cover.



Installation in waterproof concrete

The KESSEL sealing kit for installation in waterproof concrete ensures reliable protection against moisture damage. The extension section with central flange and elastomeric waterproofing membrane can also be used for deeper installation.

Additional inlet connections

In addition to the cover with integrated inlet several lateral inlets can also be attached, for a shower, washing machine and wash-basin. The *Pumpfix S* basement drain can therefore also be used as central backwater protection.

Pumpfix S

Article numbers • Data sheets
Accessories • Spareparts
Videos • Download • BIM



www.kessel.com/pumpfix-s



Backwater valve *Universale Plus*

More advantages, less hassle with an extra measure of innovation: this plan works out! On the following pages you will find out how the *Universale Plus* basement drain with integrated backwater valve and odour trap makes it even easier for you to drain basement rooms in future.

But that's not all. Also discover why you not only save time but also save money with the *Universale Plus* – from the design to the installation through to maintenance.



Universale Plus
 Article numbers • Data sheets
 Accessories • Spareparts
 Videos • Download • BIM
www.kessel.com/universale-plus



The installation is also possible without waterproofing where high groundwater is not an issue



With *Ecoguss* upper section for up to 12.5 tonne loads



Installation with waterproofing against groundwater

Backwater valve

The Universal

The versatile drain with backwater valve.

It couldn't be more flexible. *The Universal* is a versatile basement drain for sewage free wastewater. It is equipped with a backwater valve and a manually lockable emergency closure. *The Universal* has three inlets as a standard feature (two in Ø 50 and one in Ø 75 mm), the telescopic upper section is also rotatable, tiltable and height-adjustable. This ensures it provides maximum flexibility for the design and installation. *The Universal* is optionally available with a slotted grating made of polymer or stainless steel.

The Universal

Article numbers • Data sheets
Accessories • Spareparts
Videos • Download • BIM

www.kessel.com/the-universal



1 Drain 2 Inlet 3 Steel cover

Backwater valve *Drehfix*

The compact drain for renovation.

The *Drehfix* is a basement drain with integrated, removable backwater valve (Type 5). In addition, it protects connected discharge points such as washbasins, showers or washing machines against wastewater from the sewer. With odour trap, sludge bucket, manually locked emergency closure and a discharge rate of 1.8 l/s, it can be used flexibly and is so compact that it fits in the recesses of old cast iron drains. It is therefore ideally suitable for renovation projects.



1 Drain 2 Inlet

Drehfix

Article numbers • Data sheets
Accessories • Spareparts
Videos • Download • BIM

www.kessel.com/drehfix



Pumpfix F, Staufix FKA, Staufix SWA



Do you have a toilet in the basement?

Pumpfix F uses the natural gradient to the sewer!

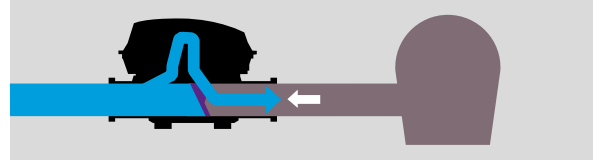

- Minimum energy consumption
- No pumping noises – increased living comfort
- No interruption in operation in the event of a power failure
- Integrated drain function

... or protect your basement using the motorised backwater valve *Staufix FKA* or mechanical backwater valve *Staufix SWA*.



Staufix Basic, Staufix



Multiple basement drainage pipes connected to a single main wastewater pipe ...

... centrally protect multiple drainage fixtures against backwater using the *Staufix* backwater valve.

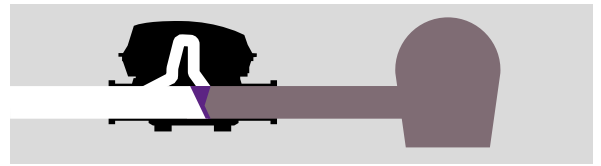

Staufix, Staufix Siphon



Sink, shower, washing machine, heating overflow

Protect the drainage fixtures elements with *Staufix* backwater valve Ø 50, Ø 75 or *Staufix Siphon* Ø 50.

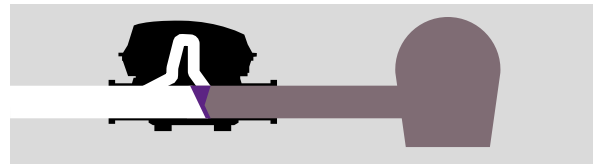

Drehfix, the Universal, the Universale Plus



Floor drain

Use *Drehfix*, *the Universal* or *the Universale Plus*.



Pumpfix S



Flooding through basement steps or windows

Pumpfix S pumps the basement dry!

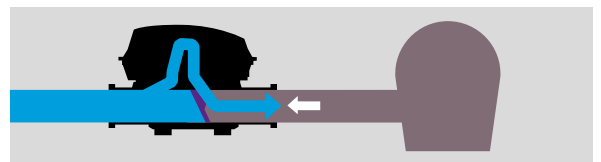

Underground backwater protection

Triple inlet underground chamber for rainwater, above ground sewer and underground sewer pipe connections. For use with KESSEL *Staufix SWA*, *Staufix FKA* and *Pumpfix F* backwater valves.

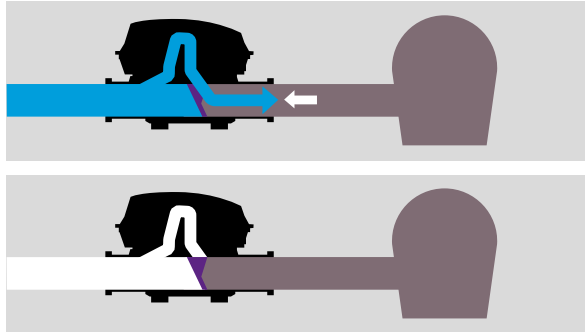

Backwater inspection chamber



In-line single flap backwater protection

For indoor or outdoor underground backwater protection in industrial sized gravity wastewater pipes.



Multitube



End of pipe backwater protection

Protection of water discharge from large public, municipal and industrial sector drainage pipes into flood prone areas (rivers, oceans and large public sewers).

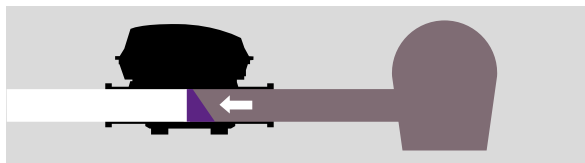

Pipe flaps



BIM

files available at
www.kessel.com



Subject to technical modifications.

KESSEL AG

Bahnhofstraße 31 • 85101 Lenting • Germany

www.kessel.com