

KNIPEX Quality – Made in Germany



# KNIPEX Industry Range

Further products on  
[www.knipex.com](http://www.knipex.com)



## Pliers for the Industry

Industrial production is characterized by paying great attention to efficiency. Every step of a process in assembly and production must be accurate and downtimes must be kept to the lowest possible level. KNIPEX pliers provide genuine support for achieving maximum productivity. Universally applicable models save a great deal of time that would otherwise be lost when changing tools, while specialist pliers with their sophisticated design permit fast work even on difficult tasks.

The KNIPEX pliers wrench, which replaces an entire set of spanners, is already a classic. Available in different sizes for every application, it grips all wrench openings firmly at any point within its operating range, whether metric or imperial, completely parallel and without damaging surfaces. Its great amplification of manual force makes it ideally suitable for gripping, holding, crimping and bending diverse components.

The KNIPEX needle nose combination pliers are an example of how a seemingly perfect pair of pliers can be made better still. They are particularly manageable, enabling easy access also to areas that are difficult to reach. With their high transmission joint, they are very strong when cutting and gripping. The anti-twist, pointed jaws will reach anywhere, the cutters can even cut hard wire with a diameter of up to 2 mm and they fit in any pocket.

The KNIPEX X-Cut® doesn't look its strength. At just 160 mm long, it is perfect for all wire, from extremely fine strand through to cables that are 12 mm thick. It is always to hand when you need to cut cable ties, adhesive tape, copper wire, steel wire and even spring steel wire with little physical effort. Its box joint design, double lateral guide and double-bearing joint axle ensure maximum stability and service life.

These and many other models of KNIPEX pliers are indispensable wherever the highest standards of quality and handling are required in production, assembly and maintenance.

### SYMBOLS

	flat jaws		with lead catcher
	half-round jaws		angle
	round jaws		weight
	flat and pointed jaws		length
	box-joint		centre cutter
	bolted joint		cutting edges with bevel
	smooth gripping surfaces		cutting edges with small bevel
	knurled gripping surfaces		cutting edges with very small bevel
	cross-hatched, knurled gripping surfaces		cutting edges without bevel
	with opening spring		for flush cut of soft materials

	electrostatic discharging, dissipative		soft wire
	electronics		medium hard wire
	VDE-tested, also in compliance with GPSG		hard wire
	insulated according to IEC 60900, usable up to 1000 V AC / 1500 V DC		piano wire
	conforms to a European directive		Cu + Al-multi-conductor cable, solid and multi-stranded
	mechanically tested in accordance with the equipment and product safety act		wire rope
	mechanically tested in accordance with the equipment and product safety act		iron
	WEEE marking (Waste Electrical and Electronic equipment Directive)		ribbon cable
			steel wire armoured cable (SWA)



### KNIPEX CoBolt S | p. 4

160 mm length, now with recess for round materials

71 31 160



### KNIPEX Cobra® XS | p. 6

Now in a 100 mm model

87 00 100



### KNIPEX Pliers Wrench | p. 8

Less weight, more performance

86 01 300



### KNIPEX TubiX® Pipe Cutter | p. 10

Faster, easier and more precise: cuts copper, brass and stainless steel pipes

90 31 02



### KNIPEX PreciStrip16 | p. 12

Automatic Insulation Stripper

12 52 195

# Compact and robust: The KNIPEX CoBolt family

Most bolt cutters derive their brutal cutting power mainly from their large size. Much unlike the "pocket bolt cutters" of the CoBolt family: They are handy and get the job done! In compact sizes of 160, 200 or 250 millimetres, they cut through even the hardest piano wires, thanks to precision cutting edges and efficient joints.



The practical gripping surface assists in gripping and pulling wires



The integrated opening spring in the 32 series models (e.g. 71 32 200) make frequent cutting easy: can be locked quickly for safe transport



**Optimum access:**  
With its slim head, the KNIPEX CoBolt cuts where other bolt cutters will not even come close.



**20°**  
angled head  
on CoBolt, e.g. 71 41 200, enables cutting close to surfaces – no injury to hands on rough walls!

**Tiny titan with 25-fold leveraging of hand strength –  
just right for round material**

Heavy-duty cutting edge with recess slices through the hardest round materials in only one cutting action

Extremely high cutting performance in a convenient length of 160 mm

Small, slim head for excellent accessibility

- > Compact and powerful: cuts bolts, nails, rivets etc. up to Ø 4.8 mm
- > Cutting edge hardness approx. 64 HRC
- > Less physical effort due to efficient lever action mechanism
- > Slippage of cutting material reduced by lasered cutting edge
- > With gripping surface below the joint for gripping and pulling wires from Ø 1.0 mm
- > Blades with recess for easier cutting of larger cross-sections thanks to better leverage close to the fulcrum
- > Chrome vanadium heavy-duty steel, forged, multi stage oil-hardened



71 31 160

**Ideal for round materials:  
the KNIPEX CoBolt with recess**

The recess enables round materials to be placed closer to the joint when cutting. The improved leverage makes easy work of cutting through even very hard materials with less effort.

Available in lengths of  
160 mm – item no. 71 31 160  
200 mm – item no. 71 31 200  
250 mm – item no. 71 31 250



**Ideal for flat materials:  
the KNIPEX CoBolt without recess**

The cutting edge without the recess provides optimum cutting for flat materials. The lasered cutting edge also keeps the cutting material from slipping.

Available in lengths of  
160 mm – item no. 71 01 160  
200 mm – item no. 71 01 200  
250 mm – item no. 71 01 250



Article No.	EAN 4003773-	↔ mm	Pliers	Handles	Cutting capacities				⚖ g
					Ø mm	Ø mm	Ø mm	Ø mm	
71 31 160	084587	160	▶▶ grey atramentized	plastic coated	5,3	4,8	3,6	3,3	195
71 31 160 SB	085850	160	▶▶ grey atramentized	plastic coated	5,3	4,8	3,6	3,3	195

# KNIPEX Cobra® XS

Only 100 mm in length:  
anything but a toy!



The slim head provides firm grip even in tight spaces



Gripping capacity  
**Ø 28 mm**



Work with only one hand: open, slide in, it fits!



**Grips like a big tool: The smallest water pump pliers in the world with full functional capability**

Optimum access in the narrowest spaces: an especially compact design with a very slim head

Single-handed fine adjustment by sliding for optimal fitting to various workpiece sizes

Long-lasting secure grip ensured by high wear resistance

- > Gripping capacity Ø 28 mm (1"), width across flats up to 24 mm – at only 100 mm length
- > Box joint: high quality and durability provided by dual guide
- > Gripping surfaces with specially hardened teeth, hardness approx. 60 HRC
- > Self-locking on pipes and nuts: no slipping on the workpiece and low handforce required
- > Pinch guard prevents operators' fingers being pinched
- > Fine adjustment with 11 adjustment positions
- > DIN ISO 8976



87 00 100  
PATENTED

**The KNIPEX Cobra® Family has grown**

In every size: perfect tightening, gripping, holding, pressing and bending with the ingenious self-locking effect



87 00 100    87 01 125    87 01 150    87 01 180    87 01 250    87 01 300    87 01 400    87 01 560



Self-locking and durable – all part of genuine KNIPEX water pump pliers



The KNIPEX Cobra® XS grips nuts up to 24 mm and other workpieces as large as Ø 28 mm



Naked truth: The grips are not coated to keep them as slim as possible. To ensure good grip, they are textured on the outside

Article No.	EAN 4003773-	↔ mm		Pliers	Head	Handles	Adjustment positions	Ø Inch	mm	g
87 00 100	085836	100		grey atramentized	polished	embossed, rough surface	11	1	24	62
87 00 100 BK	085843	100				embossed, rough surface	11	1	24	87
87 01 125	069935	125				with non-slip plastic coating	13	1	27	85
87 01 150	060116	150					11	1 1/4	30	145
87 01 180	022015	180					18	1 1/2	36	170
87 01 250	022022	250					25	2	46	335
87 01 300	034087	300					30	2 3/4	60	530
87 01 400	005636	400					27	3 1/2	95	1214
87 01 560	044321	560		20	4 1/2	120	2750			

**Now optimised: Less weight, more performance, with a larger opening width and a practical laser-cut adjustment scale**

**Higher capacity: Continuous gripping in all wrench sizes up to 68 mm (maximum 2 1/2") with use of two additional adjustment positions**

**Noticeably less weight, 80 grams lighter with the same stability**

**Practical adjustment scale: A laser-cut (metric and imperial) enables pre-setting to the width across flats**

- > Replaces a whole set of spanners – metric and imperial
- > Smooth jaws for damage-free installation of plated fittings - working directly on chrome!
- > Reliable catching of the hinge bolt: no unintentional shifting
- > Lever transmission greater than 10:1 for strong gripping power
- > Chrome vanadium electric steel, forged, oil-hardened

**For especially sensitive surfaces:**  
plastic protective jaw covers are available as accessories for all optimised pliers wrenches

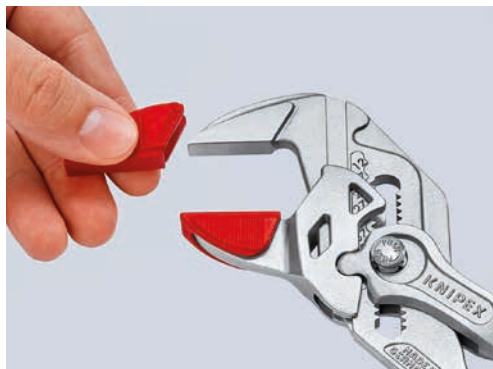

**Even better:  
the optimised pliers wrench**

The new versions of the tried-and-tested pliers wrench. You will recognise them **1** by the offset jaws, **2** the laser-cut scale for pre-setting of width across flats



86 01 180 and  
86 03 180

86 01 250 and  
86 03 250

86 01 300 and  
86 03 300

Article No.	EAN 4003773-	↔ mm		Pliers	Head	Handles	Adjustment positions	⬡ Inch	⬡ mm	⚖ g
86 03 125	077497	125	□	chrome plated		plastic coated	11	7/8	23	105
86 03 125 SB	077688	125	□	chrome plated		plastic coated	11	7/8	23	105
86 03 150	069676	150	□	chrome plated		plastic coated	14	1	27	193
86 03 150 SB	070009	150	□	chrome plated		plastic coated	14	1	27	193
86 01 180	084273	180	□	grey atramentized	polished	with non-slip plastic coating	15	1 1/2	40	230
86 01 180 SB	084303	180	□	grey atramentized	polished	with non-slip plastic coating	15	1 1/2	40	230
86 01 250	082385	250	□	grey atramentized	polished	with non-slip plastic coating	19	2	52	457
86 01 250 SB	082637	250	□	grey atramentized	polished	with non-slip plastic coating	19	2	52	457
86 01 300	084662	300	□	grey atramentized	polished	with non-slip plastic coating	24	2 1/2	68	645
86 01 300 SB	084679	300	□	grey atramentized	polished	with non-slip plastic coating	24	2 1/2	68	645
86 02 180	084280	180	□	grey atramentized	polished	with multi-component grips	15	1 1/2	40	240
86 02 180 SB	084310	180	□	grey atramentized	polished	with multi-component grips	15	1 1/2	40	240
86 02 250	082392	250	□	grey atramentized	polished	with multi-component grips	19	2	52	468
86 02 250 SB	082644	250	□	grey atramentized	polished	with multi-component grips	19	2	52	468
86 03 180	035466	180	□	chrome plated		plastic coated	15	1 1/2	40	230
86 03 180 SB	028819	180	□	chrome plated		plastic coated	15	1 1/2	40	230
86 03 250	033837	250	□	chrome plated		plastic coated	19	2	52	462
86 03 250 SB	022091	250	□	chrome plated		plastic coated	19	2	52	462
86 03 300	041429	300	□	chrome plated		plastic coated	24	2 1/2	68	645
86 03 300 SB	040927	300	□	plastic coated		plastic coated	24	2 1/2	68	645
86 03 400	077312	400	□	chrome plated		plastic coated	25	3 3/8	85	400
86 05 180	047162	180	□	chrome plated		with multi-component grips	15	1 1/2	40	250
86 05 180 SB	052180	180	□	chrome plated		with multi-component grips	15	1 1/2	40	250
86 05 250	047841	250	□	chrome plated		with multi-component grips	19	2	52	485
86 05 250 SB	052029	250	□	chrome plated		with multi-component grips	19	2	52	485
86 06 250	082408	250	□	chrome plated		insulated with multi-component grips, VDE-tested	19	2	52	515
86 06 250 SB	082651	250	□	chrome plated		insulated with multi-component grips, VDE-tested	19	2	52	515
86 09 180 V01	085805	3 pairs of plastic jaws for all 86 XX 180 mm models (models from 2019)								9
86 09 250 V01	084143	3 pairs of plastic jaws for all 86 XX 250 mm models (models from 2018)								18
86 09 300 V01	085812	3 pairs of plastic jaws for all 86 XX 300 mm models (models from 2020)								24

# All advantages of the optimised pliers wrenches at a glance:

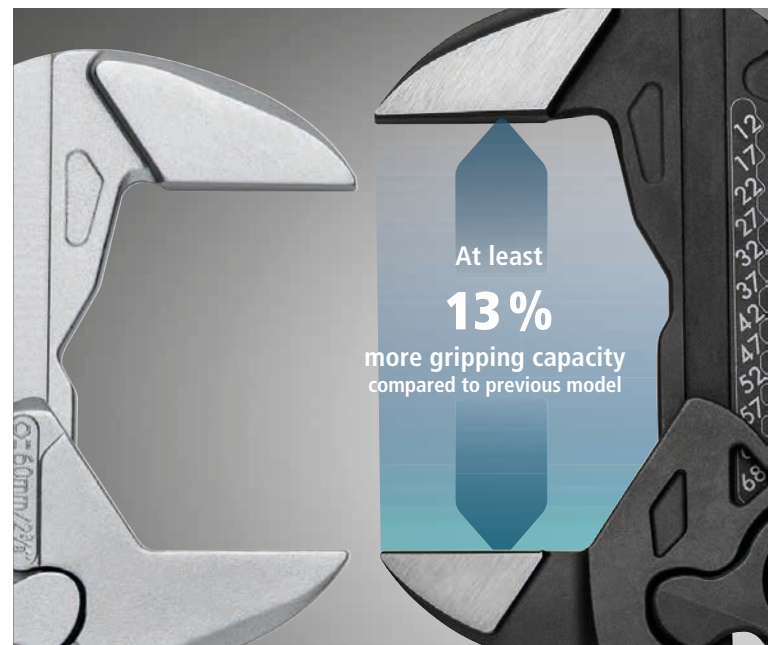
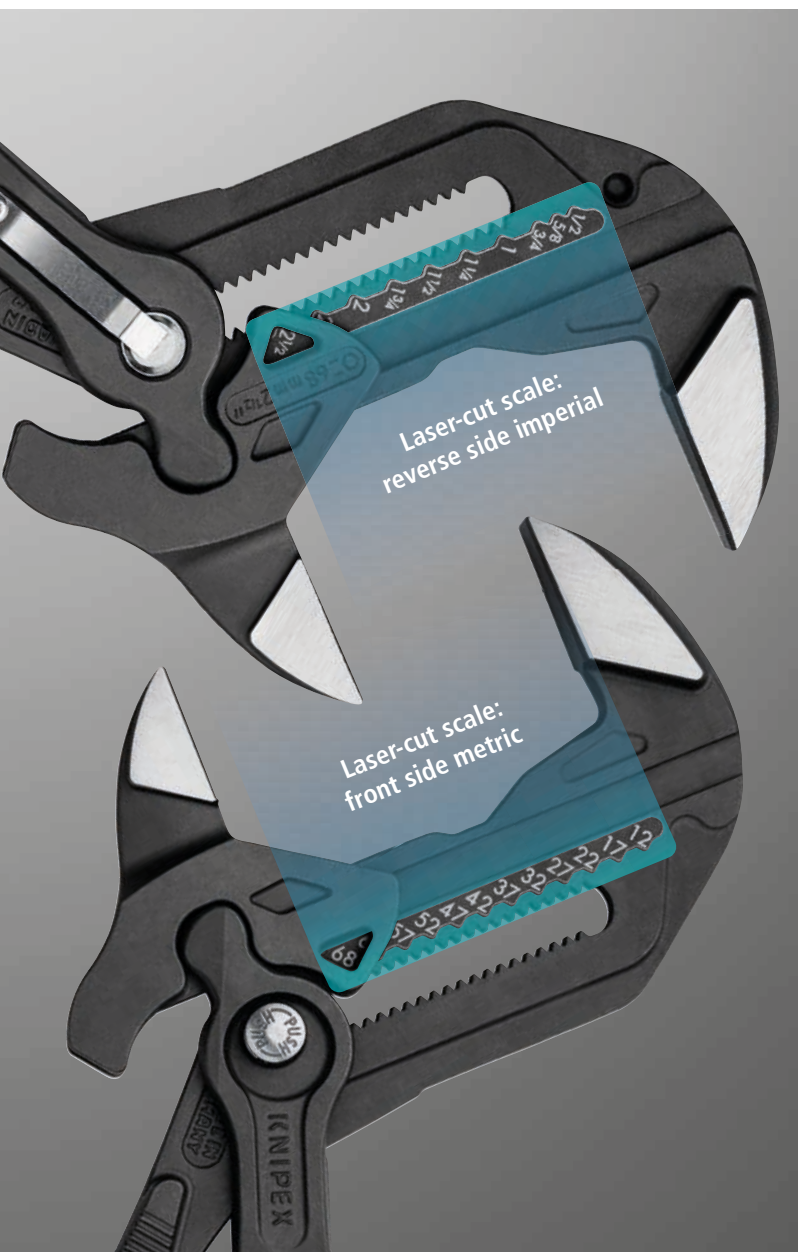

**Faster, easier and more precise: cuts copper, brass and stainless steel pipes**

**QuickLock one-hand locking mechanism: slide on, cut – finished!**

**Easy one-handed pushing for quick adjustment to different tube sizes**

**Comfortable: easy cutting due to high-quality needle bearings in the cutting wheel and guide rolls**

- > Cuts pipes from Ø 6 - 35 mm (1/4" - 1 3/8") with wall thickness up to 2 mm
- > Cutting wheel made of high-grade ball-bearing steel
- > Practical quick replace system for the cutting wheel – with spare wheel stored under the feeding barrel
- > With precision-ground deburring tool, easy to remove
- > For the electric trade: Also suitable to cut rigid steel conduits
- > Light and durable metal enclosure of magnesium



For cutting copper, brass and stainless steel pipes with wall thickness up to 2 mm and diameters of 6-35 mm (1/4" - 1 3/8")

← The overall length does not change during operation →



90 31 02



The needle-bearing and spring-loaded cutting wheel made of high-quality ball bearing steel is easily exchangeable



The spring-loaded cutting wheel can be pushed and fixed on the diameter of the pipe with the one-hand locking mechanism



Speed in everyday operation: the QuickLock one-hand locking mechanism enables the cutting wheel to slide onto any pipe diameter with a single press of the thumb



High-quality needle bearings enable the cutting wheel and the four guide rollers to operate virtually without any friction during the cutting – cuts stainless steel pipes with particular ease

### Four steps to success – how the KNIPEX TubiX® pipe cutter helps you in your work



1 Cutting now made easy: position the opened KNIPEX TubiX® ...



2 Push the cutting wheel against the pipe with the QuickLock one-hand locking mechanism: fastest adjustment to different pipe diameters ...



3 Tighten and cut with a swift twist and then readjust using the ergonomic blue feeding barrel ...



4 And you're done! If necessary, have the edge smoothed out using the fold-out deburring tool – with surprisingly little effort

Artikel-Nr.	EAN	↔	Ø mm	Ø Inch	g
90 31 02 SB	084686	180	6 - 35	1/4" - 1 3/8"	375
90 31 02 BK	084907	180	6 - 35	1/4" - 1 3/8"	375
90 39 02 V01	085874	Cutting wheel INOX Cu for 90 31 02			8
90 39 02 V02	085881	Deburring tool for 90 31 02			7
90 39 02 V03	086307	5x Cutting wheel INOX Cu for 90 31 02			25

# KNIPEX TubiX® Pipe Cutter

Faster, easier and more precise cutting

WINNER  
EISEN  
INNOVATION-  
AWARD  
2020

EISENWARENMESSE

## QuickLock one-hand locking mechanism:

Precise positioning,  
independent holding  
and clamping on  
the tube

KNIPEX

90 31 0

**Properly stripped away: with deft precision, strip everything from very fine to thick cables with stranded or solid conductors**

Simple, precise stripping of fine stranded and solid round cables with a wide capacity range from 0.08 to 16 mm<sup>2</sup> with only one pair of pliers

Good grip provided by semi-circular grooved metal holding clamps and exact cut from parabolic stripping blade

Fine adjustable zero correction of the blade setting to special material requirements, e.g. due to large temperature differences

- > With cable cutter for stranded wire from 0.08 to 16 mm<sup>2</sup>
- > With tether attachment point, suitable for KNIPEX Tethered Tools accessories
- > Inscription area for customisation
- > With adjustable length stop for precision work repeated accurately each time
- > Comfortable operation with ergonomic dual-component handle
- > Easily replaceable blade cassette



12 52 195

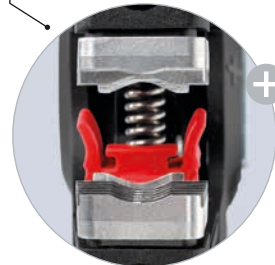

Parabolic blade separates the insulation first and then automatically pulls it back



Customisable using the inscription area

**How parabolic blades work**  
The parabolic bulging blade pair (red) extensively encloses and cuts the insulation and is thus suitable for many flexible materials

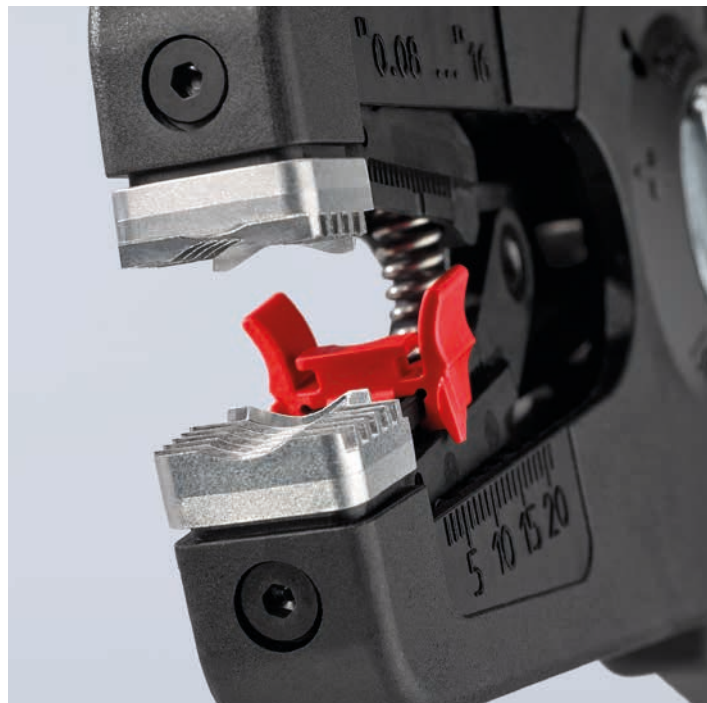

Semi-circular grooved holding clamp for better grip that holds practically any insulation material securely in place



With cable cutter on the top side for up to 16 mm<sup>2</sup>



For special requirements, such as particularly hard or soft insulation materials, optimum fine adjustments can be made using the adjustment wheel with its tactile locking positions

Article No.	EAN	↔	⊗	⊗	⚖
	4003773-	mm	mm <sup>2</sup>	AWG	g
12 52 195	085829	195	0,08 - 16	28 - 6	180
12 52 195 SB	085997	195	0,08 - 16	28 - 6	180
12 49 31	086000	Spare blade pair for 12 52 195			10

**Cable cutting made easy: innovative step cutting separates wires one by one to save energy**

Small, light, strong: comfortable cutting without crushing and just 160 mm in size

Noticeably less effort: the gradations cut wires one after the other; cutting is up to 40 % easier than with standard cable shears of the same length!

Ergonomic handle design: optimal cutting feel even for larger cable diameters

- > Cuts multi-core stranded copper and aluminium cables up to Ø 15 mm (50 mm<sup>2</sup>)
- > Cuts solid copper and aluminium cables up to 5 x 4 mm<sup>2</sup>
- > Cuts without crushing
- > Bolted joint: precise, effortless, durable
- > Pinch guard fitted for safe work
- > Not suitable for steel wire and hard drawn copper conductors
- > Cutting edges additionally induction-hardened, cutting edge hardness at least 56 HRC
- > High-grade special tool steel, forged, oil-hardened

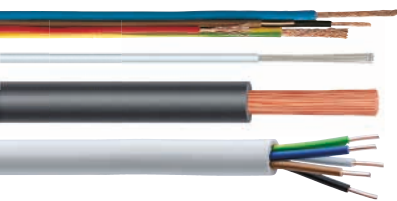

95 11 160



95 12 160



95 16 160

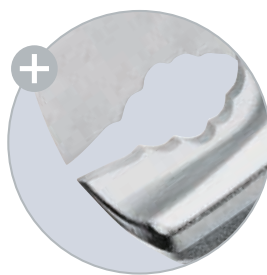

The gradations cut wires one after the other, without crushing



Cuts solid Cu- and Al-cable up to 5 x 4 mm<sup>2</sup>



Bolted joint: precise, smooth-running, durable; with pinch guard



Article No.	EAN 4003773-	↔ mm	Werkzeug	Griffe	Cutting capacities			⚖ g
					⊘ mm	mm <sup>2</sup>	AWG	
95 11 160	085904	160	burnished	plastic coated	15,0	50	1 / 0	180
95 11 160 SB	085911	160	burnished	plastic coated	15,0	50	1 / 0	205
95 12 160	085928	160	burnished	with multi-component grips	15,0	50	1 / 0	220
95 12 160 SB	085935	160	burnished	with multi-component grips	15,0	50	1 / 0	245
95 16 160	085966	160	⚡ 1000V	chrome plated, insulated with multi-component grips, VDE-tested	15,0	50	1 / 0	225
95 16 160 SB	085898	160	⚡ 1000V	chrome plated, insulated with multi-component grips, VDE-tested	15,0	50	1 / 0	250

## Pipe Cutter for plastic composite pipes

90

**Clean cut: cuts aluminium composite and plastic pipes with great precision**

For cutting composite pipes from Ø 12 - 25 mm

Clean, smooth and burr-free cut surfaces

Easily exchangeable blades

- > With opening spring and locking device
- > Ergonomically shaped handles made of fibreglass-reinforced plastic
- > Not suitable for cutting cables
- > Blade made of high-strength special grade steel, oil-hardened and tempered



Article No.	EAN 4003773-	↔ mm	Cutting capacities Ø mm	⚖ g
90 25 185	084839	185	12 - 25	175
90 25 185 SB	086093	185	12 - 25	175
90 29 01	031932	Spare blade		24



90 25 185



The high-strength, sharp blade cuts composite and plastic pipes smoothly and free of burr

## Pipe Cutter for multilayer and pneumatic hoses

90

**Perfect cutting results: the hose and pipe cutter for professional users**

Ideal for all liquid, multilayer and pneumatic hoses/pipes commonly available on the market in the wide application range from Ø 4 - 20 mm

With universal support for right-angled positioning

Easy on the hands even in continuous use thanks to low force required and automatic opening thanks to the spring mechanism

- > Easily exchangeable blades
- > With opening spring and locking device
- > Ergonomically shaped handles made of fibreglass-reinforced plastic
- > Not suitable for cutting cables
- > Blade made of high-strength special grade steel, oil-hardened and tempered



Article No.	EAN 4003773-	↔ mm	Cutting capacities Ø mm	⚖ g
90 10 185	084846	185	4 - 20	175
90 10 185 SB	086086	185	4 - 20	175
90 29 01	031932	Spare blade		24

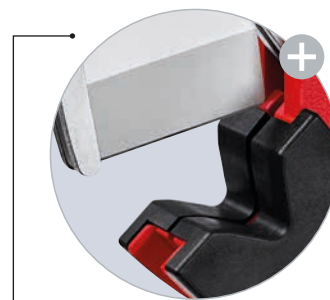

The wide support lips automatically align pipes perfectly at right angles to the blade



90 10 185



Thanks to the ergonomic handles, smooth joint and the opening spring, you can cut flexible pipes or pneumatic hoses with little effort

## Siphon and Connector Pliers

81

For siphons, oil filters, plastic pipes and connectors up to 80 mm diameter

Fine adjustment for ideal adjustment to diverse diameters

Robust, heavy duty

- > Ideal for tightening and loosening siphon screw connections, plastic pipe fittings and round union nuts
- > For connectors and couplings with screw connection, such as Cannon circular connectors
- > For gentle loosening of hoses on nozzles and filter cartridges
- > 25 adjustment positions, box-joint design
- > Ergonomic handle geometry
- > Chrome vanadium electric steel, forged, oil-hardened

**81 01 250 / 81 03 250**

- > With serrated gripping jaws; up to Ø 80 mm

**81 11 250 / 81 13 250**

- > With exchangeable plastic jaws for sensitive surfaces; up to Ø 75 mm

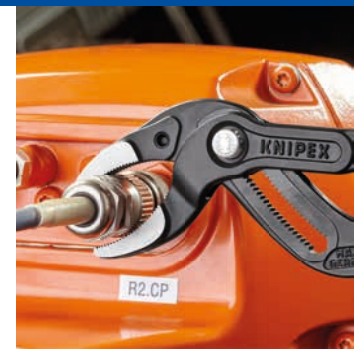

81 13 250

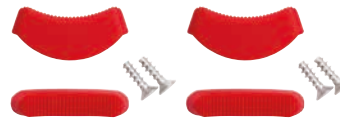

81 19 250 V01

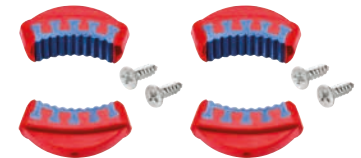

81 19 250 V02

Article No.	EAN		Pliers	Working Capacity Ø mm	Adjustment positions	↔ mm
81 01 250	078463		black atramentized, head polished	25 – 80	25	250
81 03 250	078487		chrome plated	25 – 80	25	250
81 11 250	078470		black atramentized, head polished	10 – 75	25	250
81 13 250	078494		chrome plated	10 – 75	25	250
81 19 250 V01	086550	2 pairs of plastic inserts 1C for 81 11 250 / 81 13 250				
81 19 250 V02	078500	2 pairs of plastic inserts 2C for 81 11 250 / 81 13 250				

## KNIPEX Cobra® QuickSet

Hightech Water Pump Pliers

87

2

Fully open, push, grab!

Additional fast adjustment on the workpiece by sliding the pliers handle

- > Combines the proven, reliable locking of the hinge bolt with an additional push function which makes it easier to work in very confined and inaccessible areas
- > The adjustment directly on the workpiece is possible by simply sliding the pliers handle
- > Reliable locking of the hinge bolt with the first workload. The gripping width of the pliers is then fixed and can only be adjusted by pressing the button.
- > To re-activate the sliding function, the hinge bolt must be released by pressing the push button and the pliers must be completely opened again
- > Chrome vanadium electric steel, forged, multi stage oil-hardened



PATENTED

87 21 250



Press the button – open pliers completely



Position jaw – simply slide and close pliers



Hinge bolt locks itself with the first workload

Article No.	EAN	Adjustment positions	⊙ Ø Inch	⊙ Ø mm	⬡ mm	↔ mm
87 21 250	072775	25	2	50	46	250
87 21 300	078524	25	2 3/4	70	60	300

## KNIPEX Cobra® Hightech Water Pump Pliers

87  
0

- > Push the button for adjustment on the workpiece
- > Fine adjustment for optimum adaptation to different sizes of workpieces and a comfortable handle width
- > Self-locking on pipes and nuts: no slipping on the workpiece and low handforce required
- > Gripping surfaces with special hardened teeth, teeth hardness approx. 61 HRC: high wear resistance and stable gripping
- > Box-joint design for high stability due to double guide
- > Reliable catching of the hinge bolt: no unintentional shifting
- > Guard prevents operators' fingers being pinched
- > Chrome vanadium electric steel, forged, multi stage oil-hardened

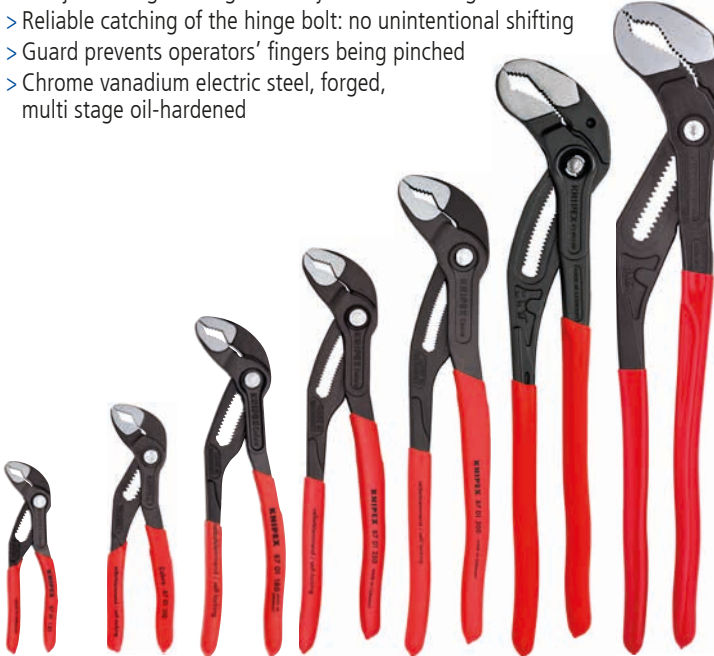

87 01 125 87 01 150 87 01 180 87 01 250 87 01 300 87 01 400 87 01 560



**KNIPEX Cobra® XL/XXL:** Greater gripping capacity but much lower weight than comparable pipe wrenches. Large gripping capacity of 95 mm, which requires a 3-inch pipe wrench.



87 26 250

Article No.	EAN 4003773-	Adjustment positions	∅ Inch	∅ mm	↔ mm
87 01 125	069935	13	1	27	125
87 01 150	060116	11	1 1/4	30	150
87 01 180	022015	18	1 1/2	36	180
87 01 250	022022	25	2	46	250
87 01 300	034087	30	2 3/4	60	300
87 01 400	005636	27	3 1/2	95	400
87 01 560	044321	20	4 1/2	120	560
87 26 250	071495	24	2	46	250

## KNIPEX Cobra® ES Water Pump Pliers extra-slim

87  
5

- > Ideal for service, maintenance and equipment repair, in automotive and general industry
- > Long, narrow jaws
- > Particularly good access to the workpiece due to very slim construction of head and joint area
- > Firm grip also on flat material due to three-point rest
- > Push the button for adjustment on the workpiece
- > Fine adjustment for optimum adaptation to different sizes of workpieces and a comfortable handle width



Due to the increasing compactness of components and machines the workspace becomes more confined. However, the requirements on the gripping force and capacity of the tools do not decrease. The KNIPEX Cobra® ES allows powerful gripping in confined areas.

Article No.	EAN 4003773-	Adjustment positions	∅ Inch	∅ mm	∅ mm	↔ mm
87 51 250	061267	19	1 1/4	32	34	250

## KNIPEX Mini pliers in belt tool pouch

00  
20

- > KNIPEX Minis as "little helpers" in the practical belt pouch
- > Tool bag made of tough polyester fabric, with hook-and-loop fastening and belt loop
- > With elastic side holder for small flash lamp, pen or suchlike

Article No.	EAN 4003773-	Content
00 20 72 V01	070832	86 03 150 Mini Pliers Wrench 87 01 125 Cobra®, Hightech Water Pump Pliers
00 20 72 V02	075851	74 01 160 High Leverage Diagonal Cutter 87 01 150 Cobra®, Hightech Water Pump Pliers
00 20 72 V06	081937	08 22 145 Needle-Nose Combination Pliers 87 01 150 Cobra®, Hightech Water Pump Pliers



00 20 72 V01



00 20 72 V06

## KNIPEX Alligator®

Water Pump Pliers

88

More output and comfort compared to conventional water pump pliers of the same length: 9-notch adjustment positioning for 30% more gripping capacity

Good access to the workpiece due to slim size of head and joint area

- > Self-locking on pipes and nuts: no slipping on the workpiece and low handforce required
- > Gripping surfaces with special hardened teeth, teeth hardness approx. 61 HRC: high wear resistance and stable gripping
- > Box-joint design for high stability due to double guide
- > Robust construction, insensitive to dirt; particularly suitable for outdoor work
- > Guard prevents operators' fingers being pinched
- > Chrome vanadium electric steel, forged, multi stage oil-hardened



Article No.	EAN 4003773-	Adjustment positions	∅ Inch	∅ mm	mm	↔ mm
88 01 180	035480	9	1 1/2	42	36	180
88 01 250	022992	9	2	50	46	250
88 01 300	034094	9	2 3/4	70	60	300
88 01 400	075844	11	3 1/2	90	95	400

## Multiple Slip Joint Spanner

87

4

- > For metric and imperial nuts and screws with widths across flats from 10 to 32 mm (3/8" up to 1 1/4"); self-locking from 17 mm: no slipping on the workpiece
- > Zero-backlash gripping of metric or imperial hexagonal headed screws, no rounding of bolt heads
- > Reliable and tight gripping of rounded, rusty, or thick coated bolts and screws



Article No.	EAN 4003773-	Adjustment positions	∅ Inch	∅ mm	↔ mm
87 41 250	054566	15	3/8 - 1 1/4	10 - 32	250

## KNIPEX SmartGrip®

Water Pump Pliers with automatic adjustment

85

- > Ideal for frequent changeovers to workpieces of different sizes
- > Automatic adjustment per one-hand operation both for right-handed and left-handed use
- > Good access to the workpiece thanks to the slim dimensions of head and joint area and flush joint bolt
- > Self-locking on pipes and nuts: no slipping on the workpiece and low handforce required

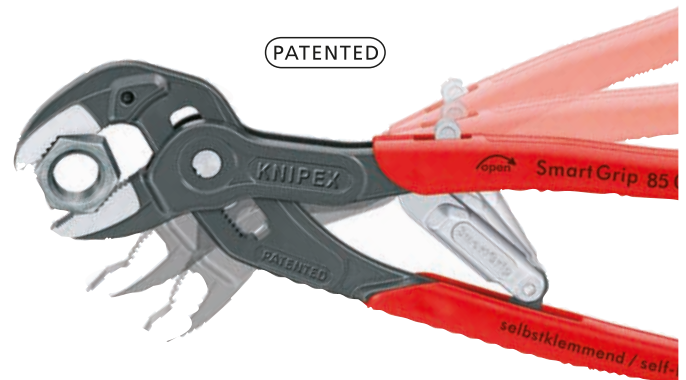

Article No.	EAN 4003773-	∅ Inch	∅ mm	mm	↔ mm
85 01 250	061304	1 1/4	32	36	250

Replaces the need for sets of metric and imperial spanners

Smooth jaws for damage free installation of plated fittings – working directly on chrome!

- > Adjustable tightening tool
- > Also excellent for gripping, holding, pressing and bending workpieces
- > Zero backlash jaw pressure prevents damage to edges of sensitive components
- > Push the button for adjustment on the workpiece
- > Parallel jaws give a more solid grip; its design allows flexible adjustment of all widths up to the specified maximum size
- > Reliable catching of the hinge bolt: no unintentional shifting
- > The ratchet type principle allows quick and easy tightening and release of all bolted connections
- > Lever transmission greater than 10 : 1 for strong gripping power
- > Chrome vanadium electric steel, forged, oil-hardened

Increased gripping capacity due to two additional setting positions: flexible gripping of all widths across flats up to 52 mm

15 % less weight with the same stability



86 01 250

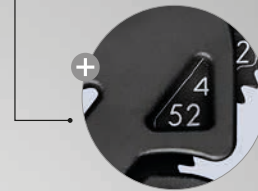

Practical adjustment scale: a laser-cut scale allows the wrench opening to be set before gripping



86 02 250



86 06 250



86 03 125 86 03 150 86 03 180 86 03 250 86 03 300 86 03 400



**86 03 125 –**  
The mini pliers wrench:  
Particularly suitable for working on small bolted connections. Very good access in very confined areas.



**86 43 250:**  
15° angled pliers handle provide space for counter screw connections or bolted fittings on surfaces; reduced risk of knuckle injuries



**86 03 400:** For opening widths up to 85 mm / 3 3/8"

Article No.	EAN 4003773-	Adjustment positions	Inch	mm	mm
86 01 250	082385	19	2	52	250
86 02 250	082392	19	2	52	250
86 03 125	077497	11	7/8	23	125
86 03 150	069676	14	1	27	150
86 03 180	035466	15	1 1/2	40	180
86 03 250	033837	19	2	52	250
86 03 300	041429	24	2 1/2	68	300
86 03 400	077312	25	3 3/8	85	400
86 06 250	082408	19	2	52	250
86 43 250	081296	17	1 3/4	46	250

## Ear Clamp Pliers

10

For the simple and reliable mounting of 1-ear and 2-ear clamps (Oetiker system or similar)

- > No damage to press points on the ear clamps
- > The slim head permits good accessibility in confined areas
- > Versatile use for clamps on CV boots, cooler and fuel lines, air pressure systems, compressors
- > Durable and strong
- > High-grade special tool steel, forged, oil-hardened

### 10 99 I220

- > Especially suitable for universal use thanks to the additional side jaw



10 98 I220



10 99 I220

Article No.	EAN 4003773-	Description	↔ mm
10 98 I220	080749	pliers black atramentized, head polished, handles plastic coated	220
10 99 I220	080756		220

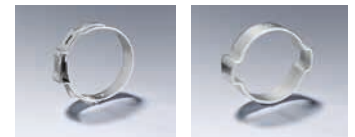

10 98 I220: Using the front press nib



10 99 I220: Using the side press nib



10 98 I220: Sealing the hose connection on central lubrication



10 99 I220: Sealing the fluid hose on the connecting piece using the side press nib

## Spring Hose Clamp Pliers

85  
51

- > Rotating, universal grip inserts for reliably gripping the clamps in all positions
- > Jaw inserts can also be rotated under load
- > Extremely good leverage which allows clamps to be opened easily without great effort
- > Slim head design; narrow head width, rotating grip inserts make this an ideal tool, especially in confined areas
- > Additional function: detach hoses gently using the serrated jaw
- > Chrome vanadium electric steel, forged, oil-hardened



85 51 180 A

Article No.	EAN 4003773-	Adjustment positions	Capacity	↔ mm
85 51 180 A	081159	15	max. 50 mm	180
85 51 250 A	077329	25	max. 70 mm	250
85 59 250 A	077336	Spare parts assortment grip inserts		

## Hose Clamp Pliers for Click clamps

85  
51

To open and close Click clamps

- > Rotating jaw inserts for the safe actuation of clamps in any position
- > Good leverage which allows clamps to be opened and closed again comfortably and easily without a great deal of effort
- > For easy working on fuel hoses, vacuum pipes and suction nozzles and many other applications
- > Additional function: detach hoses gently using the serrated jaw
- > Slim head design; narrow head width, rotating grip inserts make this an ideal tool, especially in confined areas
- > Chrome vanadium electric steel, forged, oil-hardened



85 51 180 C

Article No.	EAN 4003773-	Adjustment positions	↔ mm
85 51 180 C	081166	12	180
85 51 250 C	078517	14	250
85 59 250 C	078999	Spare parts assortment grip inserts	

## High Leverage Combination Pliers

02

35% less effort required than with conventional combination pliers  
With cutting edges (hardness approx. 63 HRC) for heavy duty

- > Easier work due to optimised leverage
- > Easier cutting, powerful gripping, bending and pulling
- > Long cutting edges for thicker cables
- > With gripping zones for flat and round material, suitable for versatile use
- > High-grade special tool steel, forged, multi stage oil-hardened



02 02 180

Article No.	EAN 4003773-	Ø mm	Ø mm	Ø mm	mm <sup>2</sup>	mm
02 02 180	034896	2.5	2.0	11.5	16.0	180
02 02 200	034902	2.8	2.2	13.0	25.0	200

## Combination Pliers

03

- > With gripping zones for flat and round material, suitable for versatile use
- > With cutting edges for soft and hard wire
- > Long cutting edges for thicker cables
- > Cutting edges additionally induction hardened, cutting edge hardness approx. 60 HRC
- > Special tool steel, forged, multi stage oil-hardened



03 02 160

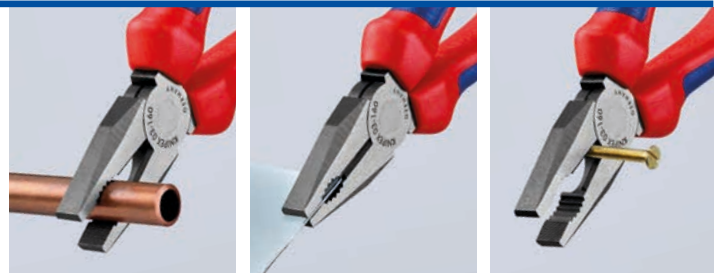

Article No.	EAN 4003773-	Ø mm	Ø mm	Ø mm	mm <sup>2</sup>	mm
03 02 160	023203	3.1	2.0	10.0	16.0	160

## Needle-Nose Combination Pliers

08

Handy use when working in confined areas thanks to slim head design and pointed jaws (anti-twist)

Gripping surfaces with special convex contour on one side for secure gripping of flat parts

Milled groove in the gripping area permits small parts such as nails, pins and bolts to be held and pulled

- > The reliable and diverse combination pliers when out and about
- > Easy cutting thanks to the high leverage joint
- > With cutting edges for soft, medium-hard and hard wire
- > Long service life and stable tips
- > Forged from special high grade tool steel, manifold oil-hardened



08 22 145



08 25 145

PATENTED

Article No.	EAN 4003773-	Ø mm	Ø mm	Ø mm	mm <sup>2</sup>	mm
08 22 145	078968	3.0	2.0	8.0	16.0	145
08 25 145	078975	3.0	2.0	8.0	16.0	145



Milled groove in the gripping area

Firm grip also on flat material due to three-point rest

Tip keeps its shape even during greater torsional forces

## Pliers for Electrical Installation

The all-rounder for professionals

13

### 6 functions in one pair of pliers

Multifunctional pliers for the electrical installation; to grip flat and round material, for bending, deburring, cutting cable, stripping and crimping wire ferrules

- > Smooth surfaces near the tips grip single cores without damaging them; serrated gripping surfaces and pipe grip for gripping flat and round material
- > Clear-cut outside edge on the jaw for working on flush-mounted junction boxes and deburring feed-through holes
- > Stripping holes for conductors of 0.75 – 1.5 mm<sup>2</sup> and 2.5 mm<sup>2</sup>
- > Crimp die for wire-end ferrules 0.5 – 2.5 mm<sup>2</sup>
- > Cable shears with (induction-hardened) precision cutting edges for copper and aluminium cables up to 5 x 2.5 mm<sup>2</sup>/Ø 15 mm
- > Slim dimensions for easy access
- > Bolted joint: precise, zero backlash operation of pliers
- > High-grade special tool steel, forged, multi stage oil-hardened

### 13 91 200 / 13 92 200 / 13 96 200

- > The intelligent latching mechanism enables you to "grip" without opening the pliers. The cutting edge remains closed and protected.

**PATENTED**



13 92 200  
MM

13 86 200

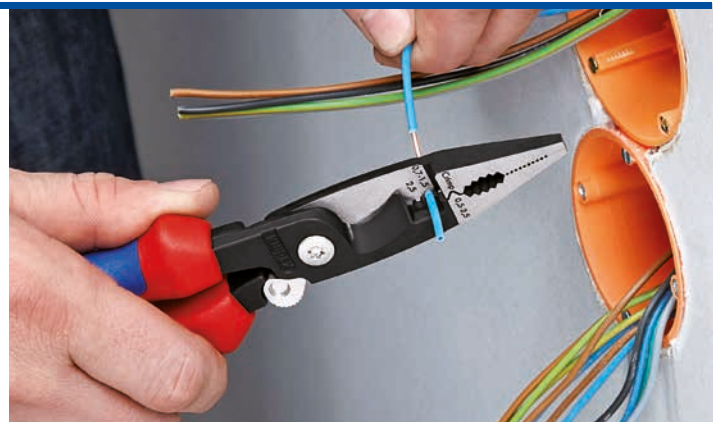

Article No.	EAN 4003773-	Handles	Cutting capacity		
			Ø mm	mm <sup>2</sup>	↔ mm
13 81 200	075240	plastic coated	15	50	200
13 82 200	075080	with multi-component grips	15	50	200
13 86 200	075097	insulated with multi-component grips, VDE-tested	15	50	200
13 91 200	075257	plastic coated	15	50	200
13 92 200	075103	with multi-component grips	15	50	200
13 96 200	075110	insulated with multi-component grips, VDE-tested	15	50	200

## Electricians' Pliers

13  
0

- > The ideal pliers for cable work
- > For gripping and bending wire
- > For cutting medium hard and hard wire
- > Precision cutting edges additionally induction hardened, cutting edge hardness approx. 60 HRC
- > With precision stripping holes
- > For crimping wire ferrules
- > Vanadium electric steel, forged, multi stage oil-hardened

Article No.	EAN 4003773-	Stripping capacities mm <sup>2</sup>	Ø mm	Ø mm	↔ mm
13 01 160	034971	0.5 – 0.75 / 1.5 / 2.5	2.5	1.6	160
13 02 160	010470	0.5 – 0.75 / 1.5 / 2.5	2.5	1.6	160



13 02 160

- > The indispensable diagonal cutter for all-round use
- > High-quality material and precise workmanship for long service life
- > Precision cutting edges for soft and hard wire
- > Clean cutting of thin copper wires, also at the cutting edge tips
- > Cutting edges additionally induction hardened, cutting edge hardness approx. 62 HRC
- > Narrow head style for use in confined areas
- > Vanadium electric steel, forged, multi stage oil-hardened



70 02 160

70 06 160



Precision rivet:  
new and more stable rivet shape



70 06 160



Cuts thin Cu wire accurately,...

also at the cutting edge tips



Article No.	EAN 4003773-					
		Ø mm	Ø mm	Ø mm	Ø mm	mm
70 02 125	034025	3.0	2.3	1.5		125
70 02 140	023098	4.0	2.5	1.8		140
70 02 160	034032	4.0	3.0	2.0		160
70 02 180	034049	4.0	3.0	2.5		180
70 06 160	021995		4.0	3.0	2.0	160

## KNIPEX X-Cut®

Compact Diagonal Cutters

Powerful, light and universal

Cuts finest strands as well as multi-core cables and piano wires

- > Box-joint design: highest stability with low weight
- > High cutting performance with minimum effort due to optimum co-ordination of the cutting edge angle and transmission ratio
- > 40% less force required compared with standard diagonal cutters of the same length
- > Large opening width for thicker cables
- > Cuts precisely, even through fine copper wires
- > Compact, low-weight construction
- > Doubly supported joint axis for heaviest duty

**40% less force required**

Compared with standard diagonal cutters of the same length.  
With double mounted hinged joint

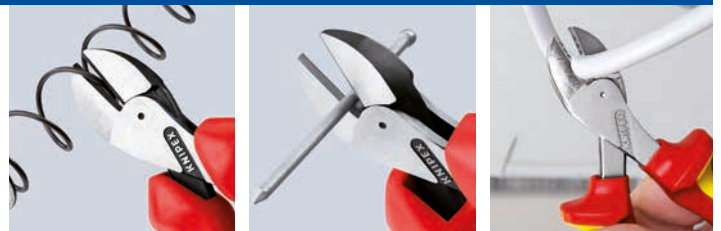

PATENTED



73 02 160

73 05 160

73 06 160

Article No.	EAN 4003773-							
		Ø mm	Ø mm	Ø mm	Ø mm	Ø mm	Ø mm	mm
73 02 160	075127	4.8	3.8	2.7	2.2	12.0		160
73 05 160	075134	4.8	3.8	2.7	2.2	12.0		160
73 06 160	075141		4.8	3.8	2.7	2.2	12.0	160

## High Leverage Diagonal Cutters

74

- > For very tough, continuous use
- > High cutting performance with minimum effort due to optimum coordination of the cutting edge angle and transmission ratio
- > Precision cutting edges additionally induction hardened (cutting edge hardness approx. 64 HRC), for all sorts of wire including piano wire
- > Chrome vanadium heavy-duty steel, forged, multi stage oil-hardened







74 02 160



74 02 180



74 06 200

Article No.	EAN 4003773-					↔ mm
74 02 160	023081	3.4	2.5	2.0		160
74 02 180	023074	3.8	2.7	2.2		180
74 02 200	040309	4.2	3.0	2.5		200
74 02 250	042402	4.6	3.5	3.0		250
74 06 200	033820		4.2	3.0	2.5	200



## KNIPEX TwinForce

High Performance Diagonal Cutters

73

72

The superior High Leverage Diagonal Cutter with patented double joint

- > Ideal transmission of force due to double-hinged design
- > Reliably cuts all types of wire, including steel tape
- > For rough or very fine cutting
- > Low cutting impact: gentle on hands. The tension on muscles and tendons is relieved
- > For comfortable cutting, repetitive cutting or extremely hard cutting jobs
- > High degree of stability and zero-backlash due to precisely milled forged-in axles
- > Chrome vanadium heavy-duty steel, forged, oil-hardened

### 73 72 180 F





- > With opening spring to simplify reapplication and for repetitive cutting



73 72 180



73 71 180

Article No.	EAN 4003773-					↔ mm
73 71 180	074762	5.5	4.6	3.2	3.0	180
73 72 180	074779	5.5	4.6	3.2	3.0	180
73 72 180 F	077657	5.5	4.6	3.2	3.0	180

## KNIPEX CoBolt

Compact Bolt Cutter

71

- > Precision cutting edges for soft and hard wire as well as piano wire
- > Cuts bolts, nails, rivets, etc. up to Ø 5.2 mm
- > Most efficient joint design ensures exceptional cutting performance with little effort
- > Cutting edges additionally induction hardened, cutting edge hardness approx. 64 HRC
- > Chrome vanadium heavy-duty steel, forged, multi stage oil-hardened

### 71 12 / 22 200

- > Opening spring and locking device are integrated in the handles also for comfortable work and protected transport

### 71 41 200

- > 20° angled head with joint bar on one side and side cutter for almost flush cutting, with space for gripping

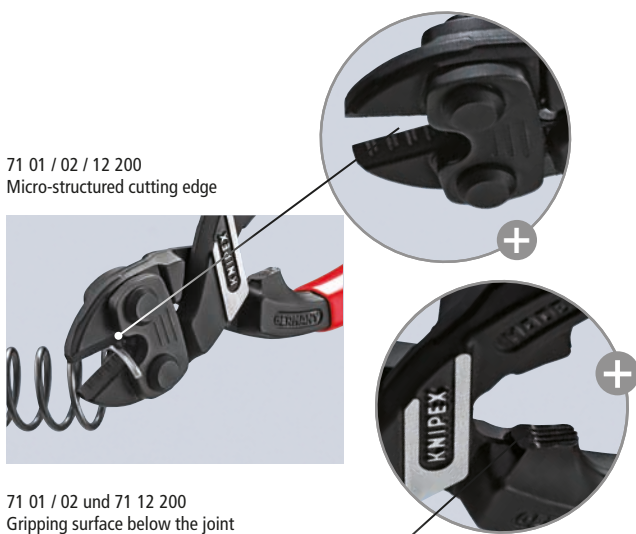

## KNIPEX CoBolt S

Compact and powerful:

Extremely high cutting performance in a convenient length of 160 mm

Small, slim head for excellent accessibility



71 02 200



71 22 200  $\sphericalangle 20^\circ$

Article No.	EAN							
	4003773-		Ø mm	Ø mm	Ø mm	Ø mm	Ø mm	mm
71 01 160	082668		5.3	4.4	3.2	3.0		160
71 01 200	033165		6.0	5.2	4.0	3.6		200
71 02 200	047056		6.0	5.2	4.0	3.6		200
71 12 200	066859	$\sphericalangle 20^\circ$	6.0	5.2	4.0	3.6		200
71 31 200	042327		6.0	5.2	4.0	3.6		200
71 22 200	066873	$\sphericalangle 20^\circ$	6.0	5.2	4.0	3.6		200
71 41 200	066897	$\sphericalangle 20^\circ$	6.0	5.2	4.0	3.6		200

## KNIPEX CoBolt XL

Compact Bolt Cutters

71

For powerful cutting of larger cross-sections as well as very hard materials

Two-hand operation for maximum cutting force

- > 60% less effort required compared to high leverage diagonal cutters of the same size
- > 40-fold increase of manual force due to special joint design
- > With gripping surface below the joint for gripping and pulling wires with a diameter as from 1.0 mm
- > Induction-hardened precision blades: cutting edge hardness approx. 64 HRC

Article No.	EAN					
	4003773-	Ø mm	Ø mm	Ø mm	Ø mm	mm
71 01 250	079637	5.6	4.0	3.8		250
71 31 250	079644	6.0	4.3	4.2		250



71 01 250



71 01 250



71 31 250

### 71 31 250

- > Blades with recess for easier cutting of larger cross-sections thanks to better leverage close to the fulcrum

## Bolt Cutters

71  
72

- > Cutting capacity up to 48 HRC hardness
- > Robust cutting edges are additionally induction hardened, cutting-edge hardness approx. 62 HRC
- > Forged-in stopper with comfortable shock-absorber
- > Good access due to very flat construction of head and joint area
- > Ergonomically angled handles to minimise effort
- > Sturdy non-slip two-colour dual component handle sleeves
- > Precise adjustment (12 positions) by eccentric bolt
- > High cutting performance with minimum effort due to optimum co-ordination of the cutting edge angle and transmission ratio
- > Bolted cutter head, replaceable
- > Blade: chrome vanadium heavy-duty steel, forged, multi stage oil-hardened
- > Joint: special tool steel, forged
- > Handles: steel tube, powder-coated

Article No.	EAN 4003773-	HRC 19 Ø mm	HRC 40 Ø mm	HRC 48 Ø mm	↔ mm
<b>71 72 460</b>	066750	8	6	5	460
<b>71 72 610</b>	066767	9	8	7	610
<b>71 72 760</b>	066774	11	9	8	760
<b>71 72 910</b>	066781	13	10	9	910



71 72 460

71 72 610

71 72 760

71 72 910

## Diagonal Cutters for plastics

72

- > Cutting face flush ground
- > For nearly flush cutting of moulded plastic components from sprues
- > Cuts soft materials such as lead in a flush cut
- > With opening spring
- > Vanadium electric steel; forged, oil-hardened

Article No.	EAN 4003773-		Description	↔ mm
<b>72 01 160</b>	041245	MM	head polished	160
<b>72 11 160</b>	046813	MM	head polished; 45°	160
<b>72 21 160</b>	046820	MM	head polished; 85°	160

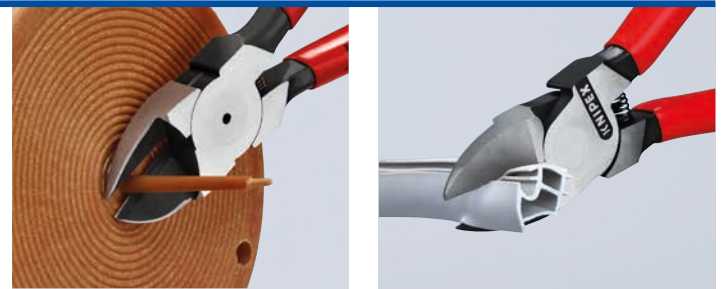

72 01 160

## High Leverage Flush Cutter

for soft metal and plastic

72  
62

- > For the flush cutting of soft materials, e.g. plastic, aluminium, copper, lead
- > Permits the energy-saving cutting of thick work components made of soft metal and plastic
- > 20° angled head with single-sided joint bar and diagonal cutting edge for flush cutting; with space for gripping
- > Opening spring and locking device are integrated in the handles also for comfortable work and protected transport
- > Precision cutting edges for soft material
- > Cutting edges additionally hardened; cutting edge hardness approx. 59 HRC
- > Chrome vanadium electric steel, forged, multi stage oil-hardened



Clean, flush cutting of copper conductor rails

Ideal for the flush cutting plastic sprues with large diameters



Article No.	EAN 4003773-	Ø mm	↔ mm
<b>72 62 200</b>	081913	6.0	160

## Wire Rope Cutter

95

Compact size, low weight, high performance level  
 High transmission joint design makes cutting 20 % easier  
 Especially precise cutter guide thanks to box joint fitted with additional stabilisation plate

- > For cutting high-strength wire ropes up to Ø 4 mm and cable up to Ø 6 mm
- > At just 160 mm long, considerably more powerful than many larger wire rope cutters
- > Convenient work thanks to opening spring
- > Secured by locking device during transport
- > Ball bearing steel for a long service life
- > Cutting edges additionally induction hardened



Double-bearing joint

User-friendly and reliable thanks to locking device and opening spring



For cutting high-strength wire ropes (1960 N/mm<sup>2</sup>) with a diameter of up to 4 mm

Article No.	EAN 4003773-	Ø mm	Ø mm	↔ mm
95 62 160	082354	6.0	4.0	160

## Wire Rope Cutters (forged)

95

- > With two crimping dies for end caps on Bowden cable sheaths and end ferrules for traction cables
- > Comfortable work thanks to handy, slim design and internal opening spring
- > Bolted joint for precise blade guidance, re-adjustable
- > High leverage for reduced effort
- > Cutting-edge hardness approx. 64 HRC
- > Chrome vanadium heavy-duty steel, forged, multi stage oil-hardened



95 62 190

Article No.	EAN 4003773-	Ø mm	Ø mm	Ø mm	Ø mm	↔ mm
95 61 190	040651	7.0	5.0	4.0	2.5	190
95 62 190	071976	7.0	5.0	4.0	2.5	190

## Wire Rope and ACSR-Cable Cutters

95

- > For wire ropes and steel rods, copper and aluminium cables
- > Suitable for cutting overhead cables with strain relief wire (ACSR-cables)
- > Angular cutting blades allow cutting of single rope wire
- > Optimum transmission ratio for high cutting performance
- > Bolted cutter head, replaceable
- > Low weight
- > Cutter head: high-grade special tool steel, multi stage oil-hardened
- > Handles: aluminium, high-strength

### 95 81 600

- > With reinforced cutter head for higher performance, also cuts piano wire



95 81 600

Article No.	EAN 4003773-	mm <sup>2</sup>	Ø mm	Ø mm	Ø mm	AWG	↔ mm
95 71 445	014522	95	10.0	7.0		4/0	445
95 71 600	014539	150	14.0	9.0		6/0	600
95 81 600	025344	150	16.0	10.0	4.5	6/0	600

## Precision Circlip Pliers

48

Precision Circlip Pliers for internal circlips in bore holes

With inserted tips for reliable work

Heavy duty in continuous operation: up to 10 times longer service life compared to turned tips

- > Bolted joint: precise, zero backlash operation of pliers
- > Non-slip plastic coating on the handles
- > Pliers body: chrome vanadium electric steel, forged, oil-hardened



48 11 J2



48 21 J21  $\angle 90^\circ$

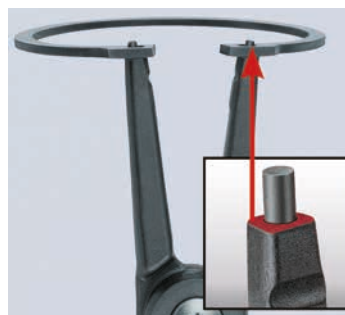

KNIPEX Precision Circlip Pliers: fit circlips without distortion; easy and quick assembling

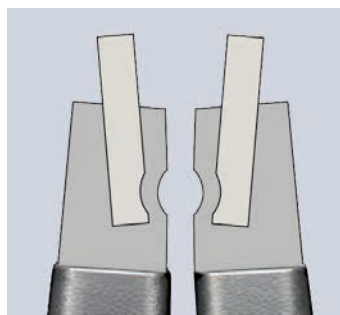

Sturdy, inserted tips: made from high-density spring steel



Article No.	EAN 4003773-	Description	Size of bore $\varnothing$ mm	Tips $\varnothing$ mm	$\longleftrightarrow$ mm
48 11 J0	048510	straight tips	8 – 13	0.9	140
48 11 J1	048527	straight tips	12 – 25	1.3	140
48 11 J2	048534	straight tips	19 – 60	1.8	180
48 11 J3	048541	straight tips	40 – 100	2.3	225
48 11 J4	048558	straight tips	85 – 140	3.2	320
48 21 J01	048619	90° angled tips	8 – 13	0.9	130
48 21 J11	048633	90° angled tips	12 – 25	1.3	130
48 21 J21	048640	90° angled tips	19 – 60	1.8	165
48 21 J31	048657	90° angled tips	40 – 100	2.3	210
48 21 J41	048664	90° angled tips	85 – 140	3.2	305
48 31 J1	073864	straight tips	12 – 25	1.3	140
48 31 J2	073871	straight tips	19 – 60	1.8	180

49

Precision Circlip Pliers for external circlips on shafts

Article No.	EAN 4003773-	Description	Size of bore $\varnothing$ mm	Tips $\varnothing$ mm	$\longleftrightarrow$ mm
49 11 A0	048718	straight tips	3 – 10	0.9	140
49 11 A1	048725	straight tips	10 – 25	1.3	140
49 11 A2	048732	straight tips	19 – 60	1.8	180
49 11 A3	048749	straight tips	40 – 100	2.3	225
49 11 A4	048756	straight tips	85 – 140	3.2	320
49 21 A01	048817	90° angled tips	3 – 10	0.9	130
49 21 A11	048824	90° angled tips	10 – 25	1.3	130
49 21 A21	048831	90° angled tips	19 – 60	1.8	165
49 21 A31	048848	90° angled tips	40 – 100	2.3	210
49 21 A41	048855	90° angled tips	85 – 140	3.2	305
49 31 A1	073895	straight tips	10 – 25	1.3	140
49 31 A2	073901	straight tips	19 – 60	1.8	180



Spring inside the joint: the spring is protected inside the precisely bolted joint. It does not hinder work and cannot get dirty or lost.



48 31 J1/J2 and 49 31 A1/A2: with overexpansion guard (adjustable using end stop), avoids overstretching of small internal circlips

## Circlip Pliers

44

Circlip Pliers for internal circlips in bore holes

- > With locking device, can be released
- > With replaceable tips made of tempered steel
- > Black powder-coated
- > Pliers body: rolled steel, high-strength
- > Tips: special tool steel, oil-hardened



44 20 J61

$\angle 90^\circ$

46

Circlip Pliers for external circlips on shafts

Article No.	EAN 4003773-	Description	Size of bore $\varnothing$ mm	Tips $\varnothing$ mm	$\longleftrightarrow$ mm
46 20 A51	025023	90° angled tips	122 – 300	3.5	570
46 20 A61	025030	90° angled tips	252 – 400	4.5	580

## Circlip Tool

for internal and external circlips up to 1000 mm nominal size

46  
10

- > Universally usable for large circlips with diameters of 400 – 1000 mm
- > Reliable opening and closing of the circlips and holding by self-locking precision spindle drive
- > For fitting and removing circlips
- > Circlips are reliably caught thanks to short, direct attachment
- > Replaceable tips having working ends with diameters of 6 and 9 mm, for perfect adaption to the handling bores in the circlips

Article No.	EAN 4003773-	Size of bore and shaft Ø mm	↔ mm
46 10 100	075417	400 - 1000	140



## Precision Circlip Pliers Set

00  
21

- > High-quality, impact-resistant plastic case
- > Contains common Precision Circlip Pliers for highest requirements
- > Precisely-sized recesses for holding the pliers
- > Clearly organised storage of tools
- > Dimensions, exterior (W x H x D): 260 x 80 x 210 mm



Article No.	EAN 4003773-	Content
00 21 25	050131	1 x 48 11 J1, 48 11 J2, 48 21 J11, 48 21 J21, 49 11 A1, 49 11 A2, 49 21 A11, 49 21 A21

## Circlip Pliers Sets

4 parts

00  
19

- > Four common Precision Circlip Pliers for highest requirements
- > Tool roll made of hard-wearing polyester fabric
- > With practical, adjustable quick release fastener



00 19 57

00 19 57 V01

Article No.	EAN 4003773-	Content
00 19 56	030973	1 x 44 11 J2, 44 21 J21, 46 11 A2, 46 21 A21
00 19 56 V01	081548	1 x 44 11 J1, 44 11 J2, 46 11 A1, 46 11 A2
00 19 57	050056	1 x 48 11 J1, 48 11 J2, 49 11 A1, 49 11 A2
00 19 57 V01	081555	1 x 48 11 J2, 44 21 J21, 49 11 A2, 49 21 A21

## Circlip Pliers Sets

00  
20

- > Contains common Circlip Pliers for internal and external circlips
- > Sturdy plastic packaging, also suitable for storage of the pliers

00 20 04 V01



00 20 03 V02



00 20 03 SB

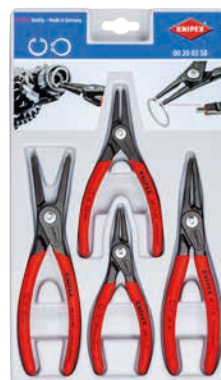

00 20 04 SB



Article No.	EAN 4003773-	Content
00 20 03 SB	050100	1 x 48 11 J1, 48 11 J2, 49 11 A1, 49 11 A2
00 20 03 V02	077640	1 x 44 11 J1, 44 11 J2, 46 11 A1, 46 11 A2
00 20 04 SB	062417	1 x 48 11 J1, 48 11 J2, 49 11 A1, 49 11 A2, 48 21 J11, 48 21 J21, 49 21 A11, 49 21 A21
00 20 04 V01	077633	1 x 44 11 J1, 44 11 J2, 46 11 A1, 46 11 A2, 44 21 J11, 44 21 J21, 46 21 A11, 46 21 A21

## Snipe Nose Side Cutting Pliers

(Radio Pliers)

25

- > Suitable for finer gripping and cutting work
- > Pointed, half-round jaws
- > Knurled gripping surfaces
- > With cutting edges for soft, medium-hard and hard wire
- > Cutting edges additionally induction hardened, cutting edge hardness approx. 61 HRC
- > Vanadium electric steel, forged, multi stage oil-hardened

Article No.	EAN 4003773-	Description	↔ mm
25 02 160	023166	Head polished; Handles with multi-component grips	160



## Snipe Nose Side Cutting Pliers

(Stork Beak Pliers)

26

Elastic tips: dimensionally stable even when twisted

- > Distortion-tolerant, elastic precision tips
- > Half-round, long, pointed jaws
- > Vanadium electric steel, forged, multi stage oil-hardened

Article No.	EAN 4003773-	Description	↔ mm
26 12 200	023142	Head polished; Handles with multi-component grips	200
26 22 200	023135	Head 40° angled; head polished; Handles with multi-component grips	200
26 16 200	022831	Pliers chrome plated; Handles insulated with multi-component grips, VDE-tested	200

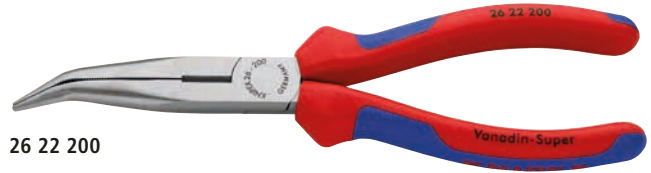

26 22 200



26 16 200

## Grip Pliers

4x

- > Hold round, profile and flat material securely
- > Heavy duty model
- > With adjustment screw and release lever
- > One-hand operation
- > High clamping pressure due to toggle lever action
- > Pliers body: rolled steel, high-strength
- > Gripping jaws: chrome vanadium electric steel, forged



41 04 250



41 34 165



41 44 200

41 44 200

- > Style: Long-Nose Grip Pliers, narrow, long jaws, Very suitable for areas that are difficult to reach, Non-serrated gripping area for pinching off hoses



40 14 250

40 14 250 Universal Grip Pliers

> with one pivoting jaw

Article No.	EAN 4003773-	○ mm	□ mm	⬡ mm	↔ mm
40 14 250	080329	43	42	45	250
41 04 180	002741	30	20	30	180
41 04 250	002758	40	20	30	250
41 04 300	022183	65	30	34	300
41 34 165	047858	20	10	24	165
41 44 200	080343	20	20	30	250

For the reliable and fast cutting of plastic corrugated pipes with the universal capacity range of diameters from 13 to 32 mm  
No damage to the internal cables or pipes

- > Simple insertion, reliable and easy cutting without waste
- > Precise cut without damage thanks to unique arrangement of the cutters with side guide
- > Good accessibility thanks to slim design
- > Made of glass fibre reinforced multi-component plastic with soft gripping zone

**90 22 02 SB**

- > With wire stripping blades for diameters of 0.2/0.3/0.8/1.5/2.5/4.0 mm
- > Location ridges (patent pending) on the 1.5 and 2.5 mm<sup>2</sup> wire stripping blades for the fast insertion of cable
- > Internal length scale for consistent stripping of cable, legible for both right and left handed users

**90 22 01 SB**  
Without stripping function



Internal blades with lateral guide to protect against injuries

**90 22 02 SB**  
With stripping function



Also for protective pipes on aluminium composite pipes in plumbing, up to a diameter of 32 mm



Clean cutting edge with no damage to internal cables as the cut is always at the top of the corrugation



90 22 02 SB: Practical locator simplifies the insertion of single conductors for stripping



Easy to use: press KNIPEX TwistCut® together, turn with slight pressure, done



Convenient handling due to fastener with locking device and opening by means of internal spring



90 22 02 SB: Injection moulded length scale for consistent stripping to a uniform length, legible for left and right handed users

Article No.	EAN	Corrugated pipe cutting performance Ø mm	Stripping capacities mm <sup>2</sup>	↔ mm
90 22 01 SB	4003773-082286	13 - 32		100
90 22 02 SB	4003773-082293	13 - 32	0.2 - 4.0	100

## Pipe Cutter

for plastic conduit pipes and hoses

90

- > For cutting thin walled plastic pipes (conduit plastic pipes) and flexible hoses, also with fabric reinforcement, of plastic and rubber up to Ø 25 mm / 1"
- > Not suitable for cutting cables
- > With opening spring and locking device
- > Tool body: plastic, fibreglass-reinforced
- > Blades: special tool steel, oil-hardened, interchangeable



Article No.	EAN 4003773-	Cutting capacities Ø mm	↔ mm
90 20 185	067122	25	185

## Pipe Cutter

for plastic conduit pipes

94

10

- > For clean cutting of plastic pipes (e.g. plastic conduit pipes) with Ø 6 – 35 mm
- > Not suitable for cutting cables
- > Blade is replaceable and can be retracted from any position
- > Low force requirement due to special blade geometry and optimum transmission
- > Minimum operator fatigue due to ergonomic handle design and incremental ratchet blade feed
- > Housing: die-cast aluminium, red lacquered
- > Blade: special tool steel, oil-hardened

Article No.	EAN 4003773-		Cutting capacities Ø mm	Cutting edge length mm	↔ mm
94 10 185	047025	MM	6 – 35	35	185



## Cable Shears

95

- > For cutting copper and aluminium single conductors as well as multiple stranded cables
- > Not suitable for steel wire and hard drawn copper conductors
- > Precision ground, hardened blades
- > Clean and smooth cut without crushing and deformation
- > Easy cutting with one-hand operation

### 95 26 165

- > Internal opening spring, protected and captive

### 95 16 200 – Cable Shears with twin cutting edge

- > Initial and final cut (upper and lower blade) allows cables of up to Ø 20 mm to be cut
- > Low handforce required due to favourable lever ratio and special blade geometry



95 26 165



95 16 200

Article No.	EAN 4003773-		⊗ Ø mm	⊗ mm <sup>2</sup>	AWG	↔ mm
95 11 165	040323		15	50	1/0	165
95 12 165	029182		15	50	1/0	165
95 16 165	039648	⚡ 1000 V	15	50	1/0	165
95 26 165	069980	MM ⚡ 1000 V	15	50	1/0	165
95 16 200	026761	⚡ 1000 V	20	70	2/0	200



Initial cut



Final cut

## Cable Cutters (ratchet action)

95  
3

- > For cutting copper and aluminium single conductors as well as multiple stranded cables
- > Not suitable for steel wire and wire ropes
- > Precision ground, hardened blades
- > Clean and smooth cut without crushing and deformation
- > One-hand operation using ratchet principle

Article No.	EAN 4003773-		Ø mm	mm <sup>2</sup>	MCM	↔ mm
95 31 250	043935		32	240	500	250
95 31 280	043942		52	380	750	280
95 36 250	026884	⚡ 1000 V	32	240	500	250
95 36 280	026891	⚡ 1000 V	52	380	750	280



## Cable Cutters

(ratchet principle, 3-stage)

95  
3

**Sturdy. Easy to use. Stable.**

**Innovative ratchet-drive.**

**For cable up to 60 mm diameter**

- > Easy handling due to low weight (825 g) and compact construction (320 mm length) – also usable in confined areas
- > Cutting through copper and aluminium cables with diameters of up to 60 mm in one-hand and two-hand operation
- > Hardened cutting edges, precisely ground, cut smoothly and neatly without crushing
- > For cutting copper and aluminium single conductors as well as multiple stranded cables (not suitable for steel wire and wire ropes)
- > Innovative three-stage ratchet-drive with high leverage for easy cutting in one-hand and two-hand operation

Article No.	EAN 4003773-		Ø mm	mm <sup>2</sup>	MCM	↔ mm
95 32 320	075172	⚡	60	600	1200	320
95 36 320	075189	⚡ 1000 V	60	600	1200	320



95 36 320

## Cable Cutters (ratchet action)

For steel wire armoured cables (SWA cable)

95  
3

**Cuts through steel wire armoured cables with a diameter of up to 45 mm / 380 mm<sup>2</sup> (e.g. 4 x 95 mm<sup>2</sup>) using one or two-handed operation**

- > Simple handling due to low weight (800 g) and compact design (315 mm length) – can also be used in confined areas
- > Precision ground blades and induction hardened cutting edges cut smoothly and neatly without crushing
- > Innovative high leverage three-stage ratchet-drive
- > Support area for putting down the pliers when cutting
- > Not suitable for cutting ACSR cable and wire rope!
- > High-grade special tool steel, forged, multi stage oil-hardened



Article No.	EAN 4003773-		Ø mm	mm <sup>2</sup>	MCM	↔ mm
95 32 315 A	078562	⚡	45	380	750	315
95 36 315 A	078579	⚡ 1000 V	45	380	750	315



95 36 315 A

## ACSR Cable Cutter

(ratchet action)

95  
3

For cables with a steel core  
Handy. Compact. Sturdy.  
Extremely robust design

- > Cuts through aluminium conductor cable with steel core up to a diameter of 32 mm in one or two-handed operation
- > Cutters with precision cut and induction hardened cutting edge
- > Two-stage ratchet drive for easy cutting
- > Less physical effort due to very high transmission ratio
- > Fixed handle with support area for putting down the pliers when cutting
- > Locking mechanism for transporting with safely closed handles
- > Special high grade tool steel, multi stage oil-hardened

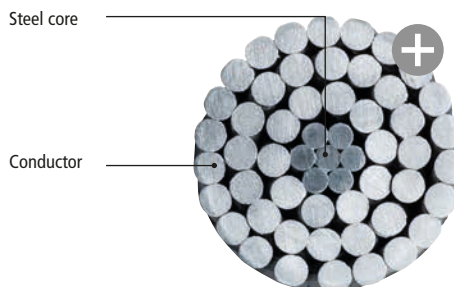

The outside of these cables consists of light, highly conductive aluminium wire, and the core of extremely non-stretch galvanised steel wires

Article No.	EAN		Pliers	Handles		Ø mm	MCM	
95 32 340 SR	4003773-081241		burnished	with multi-component grips		32	477	340

## Automatic Insulation Stripper

12  
62

- > Compact standard tool at a favourable price for all current cable cross-sections and insulating materials
- > For single, multiple and fine stranded cables of 0.2 up to 6 mm<sup>2</sup> with standard insulation
- > Adapts automatically to the respective cable cross-section; prevents damage to the conductor
- > Narrow head style for use in confined areas
- > With wire cutter for copper and aluminium wires up to 2.5 mm<sup>2</sup>
- > With adjustable length stop from 6.0 – 18.0 mm for cutting the same stripping lengths during repetitive work
- > Handy shape and low weight provide high operation comfort
- > Blades: special tool steel, oil-hardened, interchangeable



Article No.	EAN		Stripping capacities		
			mm <sup>2</sup>	AWG	
12 62 180	054573		0.2 - 6	24 - 10	180

## Self-Adjusting Insulation Strippers

12

- > For single, multiple and fine stranded conductors with plastic or rubber insulation
- > Adapts automatically to the respective cable cross-section; prevents damage to the conductor
- > Cutting depth can be adjusted for different insulation materials
- > With wire cutter for copper and aluminium wires, multiple stranded up to 10 mm<sup>2</sup> and single stranded up to 6 mm<sup>2</sup>



Wire cutter for multiple stranded wire cables up to 10.0 mm<sup>2</sup>

Adjustable length stop

Precise stripping prevents damage to the conductor



12 40 200

Article No.	EAN			
12 40 200	026662	mm <sup>2</sup>	AWG	mm
12 50 200	034407	0.03 - 10	32 - 8	200
		2.5 - 16.0	14 - 6	200

## KNIPEX MultiStrip 10

Automatic Insulation Stripper

12

Universal blade geometry – robust and more durable

Ideal grip design with excellent haptics

Recessed wire cutter

- > Fully automatic adjustment to all single-, multi- and fine-stranded conductors with standard insulation throughout the entire capacity range from 0.03 to 10.0 mm<sup>2</sup>
- > No manual fine adjustment necessary
- > No damage to the conductors
- > The clamping jaws made of steel hold the cable in a way that prevents slipping without damaging the remaining insulation
- > With recessed wire cutter for Cu and Al conductors, stranded up to 10 mm<sup>2</sup> and single wire up to 6 mm<sup>2</sup>
- > Particularly smooth-running mechanics and very low weight
- > Replaceable blades block and length stop

Article No.	EAN 4003773-	Stripping capacities mm <sup>2</sup>	AWG	↔ mm
12 42 195	054580	0.03 – 10	32 – 8	195



PATENTED



Precise stripping from 0.03 to 10 mm<sup>2</sup> without re-adjustment

Steel clamping jaws avoid slipping of the cable

Wire cutter for multiple stranded wire cables up to 10.0 mm<sup>2</sup>

## Precision Insulation Strippers

with adapted blades

12

12

- > Form-fit stripping also of difficult-to-remove insulating materials made of PTFE, silicone, Radox®, Kapton® and rubber; multi-layer too
- > A second pair of blades holds the remaining insulation reliably in place
- > Replaceable shaped blade adapted precisely to the respective conductor cross-section
- > With length stop for constant stripping length during repetitive work
- > Pliers body: steel
- > Blade: special tool steel, oil-hardened

### 12 12 02

- > With additional cable guide for exact positioning of the cable in the stripping area of the blade

### 12 12 11

- > For solar cables, specially adapted to multi-layered and RADOX® insulations
- > With additional cable support for a better centring of multi-layer insulated conductors in the stripping profiles



12 12 02

Article No.	EAN 4003773-		Stripping capacities		↔ mm
			mm <sup>2</sup>	AWG	
12 12 02	048077	⌘	0.03 – 2.08	32 – 14	195
12 12 06	049005	⌘	0.14 – 6.0	26 – 10	195
12 12 10	049012	⌘	2.50 – 10.00	14 – 8	195
12 12 11	062998	⌘	1,50 – 6.00	16 - 10	195

## Insulation Strippers

11

- > For single, multiple and fine stranded conductors with plastic or rubber insulation up to 5.0 mm dia. or 10 mm<sup>2</sup> cable cross-section
- > Easy adjustment to the required diameter of solid or stranded wire with knurled screw and lock nut
- > Special tool steel, forged, oil-hardened

Article No.	EAN 4003773-		Stripping capacities			↔ mm
			Ø mm	mm <sup>2</sup>	AWG	
11 02 160	021380	⌘	5.0	10	8	160
11 06 160	021933	⌘ ⚡ 1000V	5.0	10	8	160

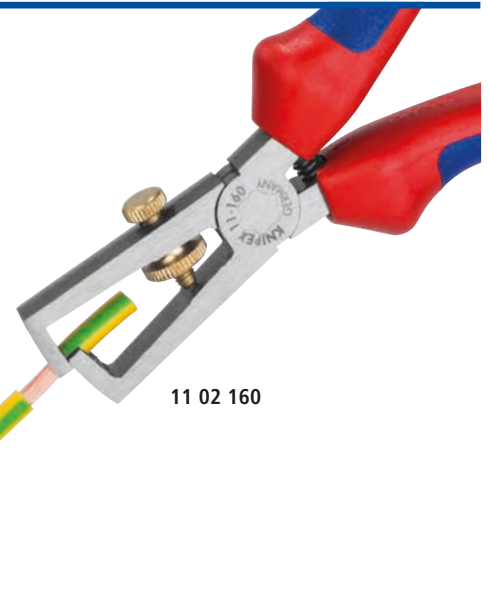

11 02 160

# KNIPEX StriX®

Insulation Strippers with Cable Shears

13  
6

## Insulation strippers with Cable Shears – two essential electrical installation tools in one pair of pliers

- > For single, multiple and fine stranded conductors with plastic or rubber insulation up to Ø 5 mm / 10 mm<sup>2</sup> cable cross-section
- > Increments in the jaw provide a visual orientation aid for stripping consistent lengths (11 mm and 16 mm)
- > Easy adjustment to the required diameter of solid or stranded wire with knurled screw and lock nut
- > Shear blade for cutting copper and aluminium cable up to Ø 15 mm (5 x 2.5 mm<sup>2</sup>)
- > Slim dimensions for easy access
- > Bolted joint: precise, zero backlash operation of pliers
- > High-grade special tool steel, forged, multi stage oil-hardened



Induction hardened precision cutter



PATENTED

13 62 180



Induction hardened shear blade with precisely ground cutting edges for crushing-free cutting of copper cables up to Ø 15 mm (5 x 2.5 mm<sup>2</sup>)



Lock nut prevents any unintentional adjustment

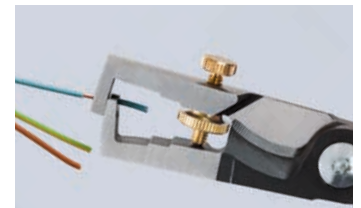

Graduated jaw is a visual orientation aid when stripping wire in standard lengths (11 mm and 16 mm)

Article No.	EAN 4003773-	Pliers	Head	Handles	Cutting capacity		Stripping capacities		
					Ø mm	mm <sup>2</sup>	Ø mm	mm <sup>2</sup>	mm
13 62 180	081302	black atramentized	polished	with multi-component grips	15	50	5.0	10	180
13 66 180	081319	chrome plated		insulated with multi-component grips, VDE-tested	15	50	5.0	10	180

# KNIPEX ErgoStrip®

## Universal Stripping Tool

16  
95

For the fast and precise dismantling and stripping of all common round and damp-proof installation cables (e.g. NYM cable 3 x 1.5 mm<sup>2</sup> up to 5 x 2.5 mm<sup>2</sup>), data cable (e.g. twisted pair) and coax cable

Innovative, ergonomic pistol grip design for easy cutting, stripping and longitudinal cut of the sheath

- > Conical, slimmed down tool ends for better access in confined areas
- > Stripping device for cross-sections 0.2/0.3/0.8/1.5/2.5/4 mm<sup>2</sup>
- > Simplified insertion of single wires for stripping using location ridges
- > With opening spring and locking device
- > Easy insertion of coax and data cable thanks to opening aid
- > Multi-component design with a soft plastic zone for comfortable use and a secure grip
- > Housing made from stable glass fibre reinforced plastic



Stripping of the sheath of a NYM cable



Stripping of the insulation of a coax cable

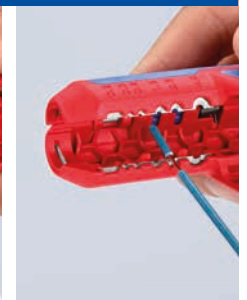

Wire stripping on single conductors

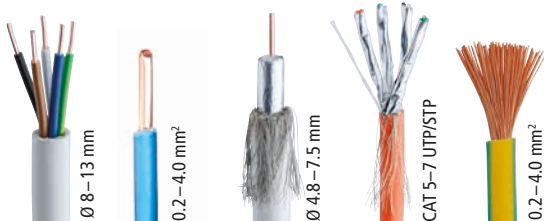

16 95 01 SB  
Version for right-handers

PATENTED



16 95 02 SB  
Version for left-handers

Article No.	EAN 4003773-		Stripping capacities				mm
			round cable Ø mm	conductors and strands mm <sup>2</sup>	data cable	coax cable Ø mm	
16 95 01 SB	079927	MM	8 - 13	0.2 - 4	CAT 5 - 7, Twisted-Pair (UTP/STP)	4.8 - 7.5	135
16 95 02 SB	082910	MM	8 - 13	0.2 - 4	CAT 5 - 7, Twisted-Pair (UTP/STP)	4.8 - 7.5	135

## Cable Knife

insulating multi-component handle, VDE-tested

98  
5

- > Ergonomically improved handle shape with comfortable slip guard
- > Particularly confident grip thanks to slip-proof soft components
- > Thumb recess and "finger hook" at the end of the handle ensure a good transmission of force when the blade is pulled
- > Solid, fixed straight blade
- > Transparent protective cap
- > Blade: special tool steel, oil-hardened



Article No.	EAN		Blade length mm	↔ mm
98 52	4003773-035565	⚠ 1000 V	50	190

## Stripping Knife

insulating multi-component handle, VDE-tested

98  
5

- > Ergonomically improved handle shape with comfortable slip guard
- > Particularly confident grip thanks to slip-proof soft components
- > Thumb recess and "finger hook" at the end of the handle ensure a good transmission of force when the blade is pulled
- > Solid, fixed straight blade
- > Transparent protective cap
- > Blade: special tool steel, oil-hardened



Article No.	EAN		Blade length mm	↔ mm
98 55	4003773-022558	⚠ 1000 V	38	180

## Stripping Tools

16  
30

Universal tool with adjustable cutting depth and three types of cut: round, lengthwise and spiral cut

- > For stripping round cable sheaths made of PVC, rubber, silicone or PTFE from 6.0 – 29.0 mm dia.
- > Self-tightening holding lever
- > With knurled nut for cutting depth adjustment



Article No.	EAN	Stripping capacities Ø mm	↔ mm
16 30 135 SB	4003773-033349	6.0 – 29.0	135
16 30 145 SB	081029	19.0 – 40.0	150

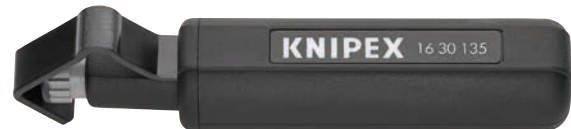

## Automatic Stripping Pliers

For multicore cable Ø 4.4 to 7.5 mm with irregular sheathing cross-section

12  
74

For control and sensor cables / actuator cables, also for stripping flexible 3-core feed cables and extension cable

Automatic adjustment to cable diameters between 4.4 and 7.5 mm

No damage to the inner conductor or shield braid

- > For oil-resistant, halogen-free control and sensor / actuator cables with multicore cable design, shielded and unshielded
- > Suitable for highly flexible TPE-U-pipes, PUR and PVC cable sheathing, rubber leads such as H05 etc.
- > Long stripping lengths possible
- > Body: plastic, fibreglass-reinforced
- > Exchangeable blade: special tool steel, oil-hardened

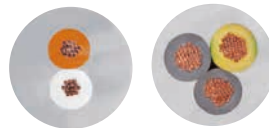

Sectional view of an extension lead



Required stripping length easy to read off



Complex cutter design for precise and damage-free stripping of round cables

Article No.	EAN	Stripping capacities Ø mm	↔ mm
12 74 180 SB	4003773-082323	4.4 - 7.5	175
12 79 31	082682	1 pair of spare blades for 12 74 180 SB	

## KNIPEX MultiCrimp

Crimping Pliers with changer magazine

97

33

Also for insulated and non-insulated wire ferrules 10 / 16 / 25 mm<sup>2</sup>  
 Universal indent crimping die for non-insulated connectors

- > Just one tool for the most common crimping applications
- > Crimping dies changed quickly and easily without any additional tool
- > Sorted and protected storage of the interchangeable dies in a round magazine
- > Comfortable, powerful crimping pliers in professional quality
- > Same reliable crimping results as with fixed crimping dies



97 33 02



PATENTED

Article No.	EAN				Capacity mm <sup>2</sup>	AWG	↔ mm
97 33 02	4003773-066934			MM	KNIPEX MultiCrimp		250
					non-insulated open plug type connectors (plug width 4.8 + 6.3 mm)	0.5 – 6	20 – 10
					insulated terminals, plug connectors + butt connectors	0.5 – 6	20 – 10
					insulated + uninsulated wire ferrules	0.5 – 6	24 – 10
					insulated + uninsulated wire ferrules	10 / 16 / 25	8 / 6 / 4
					non-insulated crimp terminals, tube and compression cable lugs in accordance with DIN 46234 and DIN 46235 and non-insulated crimp, butt and press connectors in accordance with DIN 46341 and DIN 46267	0.5 – 10	20 – 8

## Crimping Pliers

97

22

- > For cutting cables, stripping wire and crimping insulated and non-insulated terminals, connectors and plug type connectors
- > With threaded holes for cutting copper and brass screws threaded M 2.6/M 3/M 3.5/M 4 and M 5
- > Bolted joint for higher stability and even movement
- > Special steel, high-strength

Article No.	EAN			Capacity		↔ mm
				mm <sup>2</sup>	AWG	
97 22 240	4003773-070726			0.5 – 6.0	20 – 10	240
				0.5 – 2.5	20 – 14	
97 32 240	079491			0.5 – 6.0	20 – 10	240



97 22 240

## KNIPEX PreciForce

97

52

- > Repetitive, high crimping quality due to precision dies and integral lock (self-releasing mechanism)
- > Crimping pressure has been set precisely (calibrated) in the factory, re-adjustable
- > Optimum transmission of force thanks to toggle lever for fatigue-reduced operation

Article No.	EAN			Capacity		↔ mm
				mm <sup>2</sup>	AWG	
97 52 33	4003773-051862			0.5 - 10	20 - 8	220
97 52 34	051879			0.1 - 2.5	27 - 14	220
97 52 35	051886			0.5 - 6	20 - 10	220



97 52 33



97 52 35

# Self-Adjusting Crimping Pliers for wire ferrules

with lateral access

97  
53

Square compression now additionally also for wire ferrules up to 16 mm<sup>2</sup>

- > Suitable in particular for all twin wire ferrules up to 2 x 4 mm<sup>2</sup> or 2 x AWG 12
- > Square compression for ideal contact surfaces in the clamp connection



Crimping capacity can be switched over simply from 10 mm<sup>2</sup> to 16 mm<sup>2</sup>.

## The small crimping pliers for wire ferrules with two major advantages for the user:

- > Automatic adjustment to the end sleeves used: This makes work easier for the professional and offers reliable and fast crimping.
- > Expanded range of applications



97 53 04



0.08 - 10 mm<sup>2</sup> + 16 mm<sup>2</sup>

PATENTED

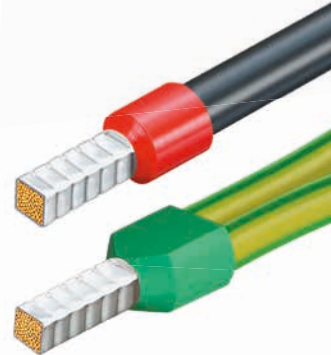

Square compression

## Proven functions

- > For crimping wire ferrules according to DIN 46228 parts 1 + 4
- > Self-adjusting adaptation to the desired wire ferrules size: no wrong crimps caused by using the wrong die
- > Repetitive, high crimping quality due to integral lock (self-releasing mechanism)
- > Tools have been set precisely (calibrated) in the factory
- > Optimum transmission of force thanks to toggle lever for fatigue-reduced operation
- > Handy shape and low weight provide high operation comfort

## Expanded capacity of hexagonal crimping up to 10 mm<sup>2</sup>

- > Suitable in particular for all twin wire ferrules up to 2 x 4 mm<sup>2</sup> or 2 x AWG 12
- > Hexagonal compression for confined connection dimensions



97 53 14



0.08 - 10 mm<sup>2</sup>

PATENTED

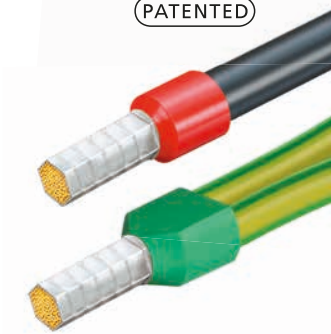

Hexagonal compression

Article No.	EAN			Pliers	Handles	Application	Capacity mm <sup>2</sup>	AWG	↔ mm
97 53 04	028017			burnished	with multi-component grips	wire ferrules	0.08 - 10 + 16	28 - 6	180
97 53 14	041474			burnished	with multi-component grips	wire ferrules	0.08 - 10	28 - 8	180

## Self-Adjusting Crimping Pliers for wire ferrules

with front loading

97  
53

- > For crimping wire ferrules according to DIN 46228 parts 1 + 4
- > Self-adjusting adaptation to the desired wire ferrules size: no wrong crimps caused by using the wrong die
- > Front loading of the wire ferrules into the tool
- > Repetitive, high crimping quality due to integral lock (self-releasing mechanism)
- > Crimping pressure has been set precisely (calibrated) in the factory, re-adjustable
- > Optimum transmission of force thanks to toggle lever for fatigue-reduced operation
- > Handy shape and low weight provide high operation comfort
- > Chrome vanadium electric steel in special quality, oil-hardened

### 97 53 09

- > With selector lever for setting the crimping area either to 0.08 – 10 mm<sup>2</sup> or 16 mm<sup>2</sup>
- > For twin wire ferrules 2 x 10 mm<sup>2</sup> and up to Ø 6.6 mm

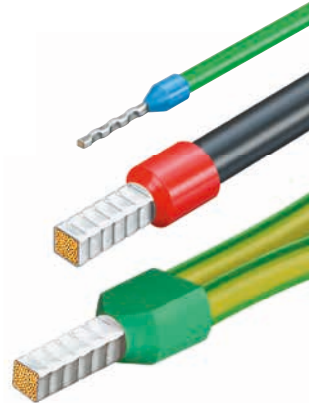

Square compression

Article No.	EAN 4003773-			Pliers	Handles	Application	Capacity mm <sup>2</sup>	AWG	↔ mm
97 53 09	044550			burnished	with multi-component grips	wire ferrules	0.08 - 10 + 16	28 - 6	190

## KNIPEX Twistor® 16

Self-adjusting crimping pliers for wire ferrules with rotating crimp head

97  
53

- Crimp head can be freely rotated 360°, with 8 locking positions**
- Square crimp profile, high capacity range of 0.14 to 16 mm<sup>2</sup>**
- Wire ferrules can be crimped from almost any working position**

- > Crimping pliers adjust automatically to different cross-sections
- > Crimp opening accessible from both sides, extra-long wire ferrules can be fed in
- > Crimping of twin wire ferrules up to 2 x 6 mm<sup>2</sup> possible
- > Repetitive, high crimping quality due to integral lock (self-releasing mechanism)
- > Light and handy tool, manual force reinforced by toggle lever mechanism
- > Chrome vanadium electric steel in special quality, oil-hardened



Crimp head can be rotated 360° for optimal accessibility, even in confined spaces

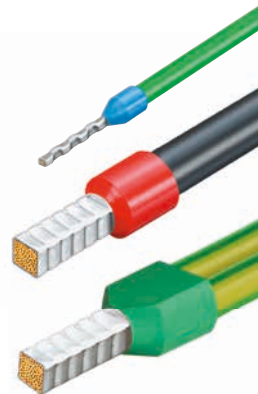

Hexagonal compression

Uniquely flexible: connectors can be inserted in the rotatable crimp head from almost any position

Article No.	EAN 4003773-			Capacity mm <sup>2</sup>	AWG	Number of crimping positions	↔ mm
97 53 18	082729			0.14 - 16	26 - 6	1	200

# KNIPEX TwinKey®

For all standard cabinets and shut-off systems

00  
11

10 profiles. 2 crosses. 1 key.

All common locking systems

- > Multifunctional key for the actuation of locking systems from the areas of facilities engineering (heating and sanitation, air conditioning, electro technology), gas and water supply and shut-off-systems
- > 8-arm version: two 4-way spider keys connected in a space-saving way using magnets
- > Reversible bit: 1.0 x 7 mm slot and PH2 cross slot
- > Key and reversible bit joined by stable stainless steel wire
- > Quality surface coating
- > Weight-optimised zinc die-cast design



PATENTED



Article No.	EAN 4003773-	 mm	 mm	 Ø mm	 mm	 mm	 mm
00 11 01	074670	5 / 6 - 7 / 8 - 9 / 10 - 11	7 - 8 / 9 - 10 / 11 - 12	3 - 5	6	6 - 9	92

# Precision Electronics Gripping Pliers





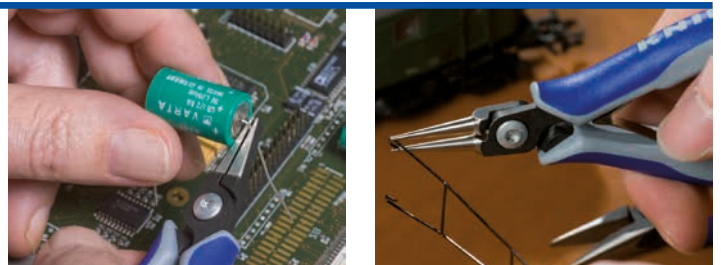













34

- > For very precise assembly work, e.g. in electronics and fine mechanics
- > For gripping, holding and bending
- > Electrically discharging handles – dissipative
- > Smoothly ground gripping surfaces, edges finely rounded
- > Approx. 20% lighter than conventional electronics pliers
- > Bolted joint and carefully manufactured joint surfaces for even, low-friction movement throughout the entire opening range
- > Smooth-running double spring for a gentle and even opening
- > Ergonomically optimised multi-component handles
- > Ball bearing chrome steel, forged, multi stage oil-hardened



34 12 130



Article No.	EAN 4003773-	     	Style	Pliers	Head	Handles	 mm
34 12 130	061458	     	flat, wide jaws	burnished	polished	with multi-component grips	135
34 22 130	061472	     	half-round jaws	burnished	polished	with multi-component grips	135

## New design, easier to use: KNIPEX Electronics Pliers

KNIPEX presents the re-engineered electronics diagonal cutters, end cutting nippers and gripping pliers with box joint design. Whether in terms of durability, transmission of force or dexterity, the new models are more compact and more powerful in many areas:

- ▶ Improved durability due to material change to ball bearing steel
- ▶ Greater joint stability: the large double guided box joint design allows for a long, zero backlash use
- ▶ Greater "dexterity": the geometry adjustments of the pliers ensure a uniform bending behavior and increase the sensitivity when working.



Comfortable to use with  
replaceable, friction-free  
opening spring

- > Precision pliers for fine assembly work, e.g. in electronics and fine mechanics
- > For gripping, holding and bending
- > Sturdy, zero backlash box joint
- > Smooth ground gripping surfaces
- > Edges carefully deburred
- > Low-friction double spring for gentle and even opening
- > The polish or mirror polish (only finish 2) together with a fine film of oil offer effective rust protection – no circuit faults caused by peeling chrome from plated tools
- > Special tool steel, forged, oil-hardened

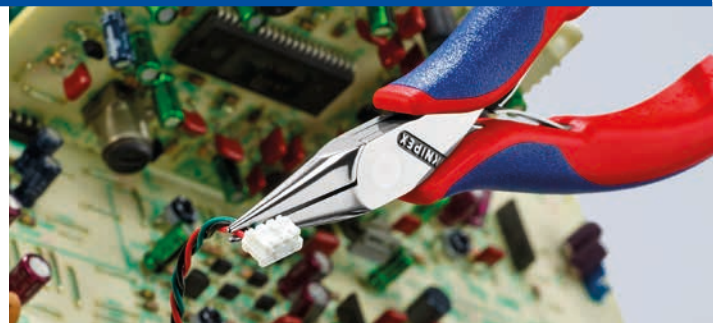

35 12 115 ESD



35 22 115



### ESD pliers (electrostatic discharge)

electrostatic energy is discharged through the handles in a gradual and controlled manner, which protects components endangered by electrostatic discharge in accordance with applicable standards, e.g. IEC TR 61 340-5, DIN EN 61 340-5, SP Method 2472.

Article No.	EAN 4003773-		Head	Handles	↔ mm
35 11 115	016694		mirror polished	plastic coated	115
35 12 115	035107		mirror polished	with multi-component grips	115
35 12 115 ESD	024835		mirror polished	with multi-component grips	115
35 21 115	016724		mirror polished	plastic coated	115
35 22 115	035114		mirror polished	with multi-component grips	115
35 22 115 ESD	024842		mirror polished	with multi-component grips	115
35 31 115	016762		mirror polished	plastic coated	115

- > Precision pliers for ultra fine cutting work, e.g. in electronics and fine mechanics
- > Sturdy, zero backlash box joint
- > Low-friction double spring for gentle and even opening
- > The polish or mirror polish (only finish 2) together with a fine film of oil offer effective rust protection – no circuit faults caused by peeling chrome from plated tools
- > Cutting edges additionally induction hardened, cutting edge hardness at least 56 HRC
- > High-grade special tool steel, forged, multi stage oil-hardened



Article No.	EAN 4003773-	Style	Head	Handles	Cutting capacity			↔ mm	
					∅ mm	∅ mm	∅ mm		
64 02 115	035343		with bevel	mirror polished	with multi-component grips	2.0	1.0	0.6	115
64 11 115	017769		without bevel	mirror polished	plastic coated	1.4	0.8		115
64 12 115	040743		with small bevel	mirror polished	with multi-component grips	1.4	0.8	0.5	115
64 12 115 ESD	024323		with small bevel	mirror polished	with multi-component grips	1.4	0.8		115

- > For fine cutting work, e.g. in electronics and fine mechanics
- > Sturdy, zero-backlash box joint
- > Low-friction double spring for gentle and even opening
- > The polish or mirror polish (only finish 2) together with a fine film of oil offer effective rust protection – no circuit faults caused by peeling chrome from plated tools
- > Cutting edges additionally induction hardened
- > High-grade special tool steel, forged, multi stage oil-hardened



Article No.	EAN 4003773-	Icons	Style	Head	Handles	Cutting capacity			↔ mm
						Ø mm	Ø mm	Ø mm	
77 01 115	018568	⚡ ⚡ ⚡ ⚡	Round head, with bevel	mirror polished	plastic coated	0.3 - 1.6	1.2	0.6	115
77 02 115	039334	⚡ ⚡ ⚡ ⚡	Round head, with small bevel	mirror polished	with multi-component grips	0.3 - 1.6	1.2	0.6	115
77 02 115 ESD	025092	⚡ ⚡ ⚡ ⚡	Round head, with small bevel	mirror polished	with multi-component grips	0.3 - 1.6	1.2	0.6	115
77 41 115	082316	⚡ ⚡ ⚡ ⚡	Pointed head, without bevel	mirror polished	plastic coated	1.3	0.8		115
77 42 115	039761	⚡ ⚡ ⚡ ⚡	Pointed head, without bevel	mirror polished	with multi-component grips	0.3 - 1.3	0.8		115
77 42 115 ESD	031901	⚡ ⚡ ⚡ ⚡	Pointed head, without bevel	mirror polished	with multi-component grips	0.3 - 1.3	0.8		115

# Electronic Super Knips Electronic Super Knips XL

- > For ultra fine cutting work, e.g. in electronics and fine mechanics
- > In particular for cutting cable ties to length
- > Ground, very sharp cutting edges without bevel
- > Shear cut with controlled micro cutting edge misalignment for the most precise cutting of even the thinnest of wires and for a long service life
- > Precision shaped tips cut wires resting on a board from Ø 0.2 mm
- > Joint with stainless steel rivet
- > Extremely smooth movement for minimum operator fatigue
- > With opening spring and opening limiter

### 78 03 140 / 78 03 140 ESD

> Cutting edge hardness approx. 54 HRC; INOX – stainless steel

### 78 61 140 / 78 61 140 ESD

> Cutting edge hardness approx. 64 HRC;  
Cutting edges additionally induction hardened



Article No.	EAN 4003773-	Icons	Pliers	Head	Handles	Cutting capacity		
						Ø mm	Ø mm	↔ mm
78 03 125 ESD	025146	⚡ ⚡ ⚡ ⚡		polished	with multi-component grips	0.2 - 1.6	1.0	125
78 06 125	084099	⚡ 1000V ⚡ ⚡ ⚡ ⚡		polished	insulated with multi-component grips, VDE-tested	0.2 - 1.6	1.0	125
78 03 140	081647	⚡ ⚡ ⚡ ⚡		polished	with multi-component grips	0.2 - 2.1	1.2	140
78 03 140 ESD	081661	⚡ ⚡ ⚡ ⚡		polished	with multi-component grips	0.2 - 2.1	1.2	140
78 61 140	081685	⚡ ⚡ ⚡ ⚡	burnished		with multi-component grips	0.2 - 2.1	1.4	140
78 61 140 ESD	081708	⚡ ⚡ ⚡ ⚡	burnished		with multi-component grips	0.2 - 2.1	1.4	140

# PLIERS ABC – TECHNICAL BASICS

## BASIC SHAPES OF THE JAWS

flat jaws

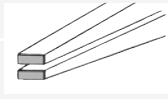

half-round jaws

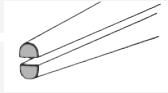

round jaws

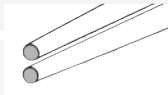

**Cutting Pliers**  
for cutting or nipping (diagonal, centre and end cutters, carpenters' pincers etc.)



**Gripping Pliers**  
(flat-, long-nose and water pump pliers etc.)

## JOINT CONNECTIONS

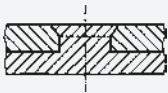

**Forged-in joint axle**

The rivet is part of one handle (forged from one piece)  
> high stability for highest strain  
> long service life

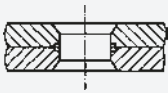

**Joint with inserted rivet**

A proved, sturdy and precise rivet connection for all standard pliers.

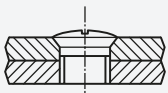

**Bolted joint**

For particularly demanding requirements in terms of precision and smooth operation, e.g. in circlip pliers and cable shears (even the finest multi-stranded conductors have to be cut cleanly).



**Combined Pliers**  
for cutting and gripping (combination, stork beak and radio pliers etc.)



**Special Pliers**  
for special applications, e.g. notching or punching different types of materials (sheet-metal nibbler, tile nibbling pincers etc.)

## TYPES OF JOINTS

**Lap joint**

The two plier halves lie on top of each other but are not milled out.

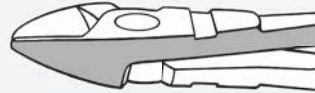

**Single joint**

Half the thickness in each pliers handle is milled away in the joint area so that both handles can be laid into each other.

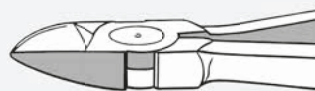

**Box joint**

One handle on the pliers is slit. The other handle is pushed through this slot. This joint connection can withstand a high level of load and strain because the joint bolt is supported on both sides and the inside handle is guided on both sides.

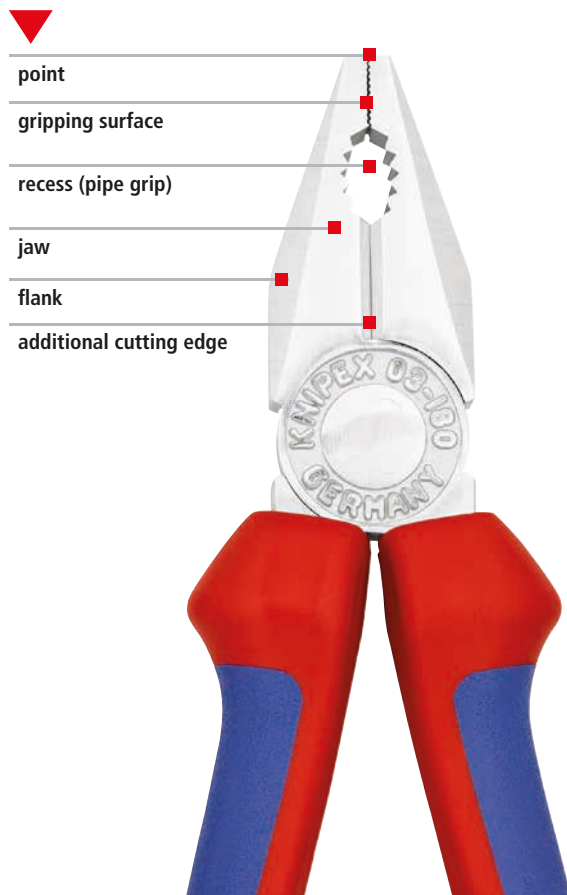
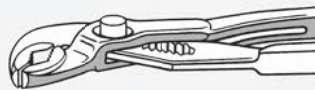

- point
- gripping surface
- recess (pipe grip)
- jaw
- flank
- additional cutting edge

# CUTTING EDGE – TECHNICAL BASICS

## Direction and position of cutting edges

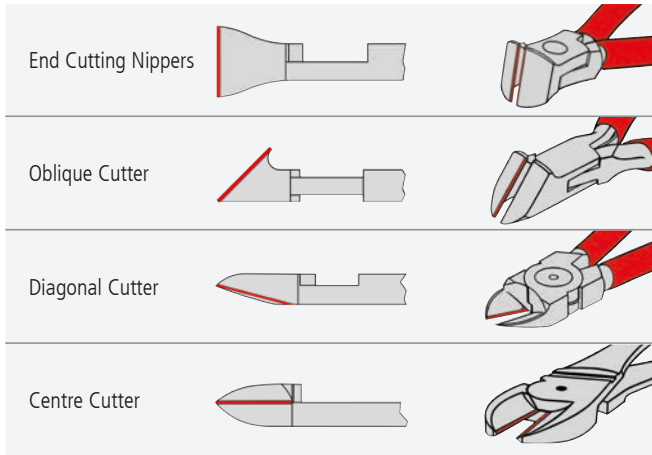

## Cutting edge shapes DIN ISO 5742

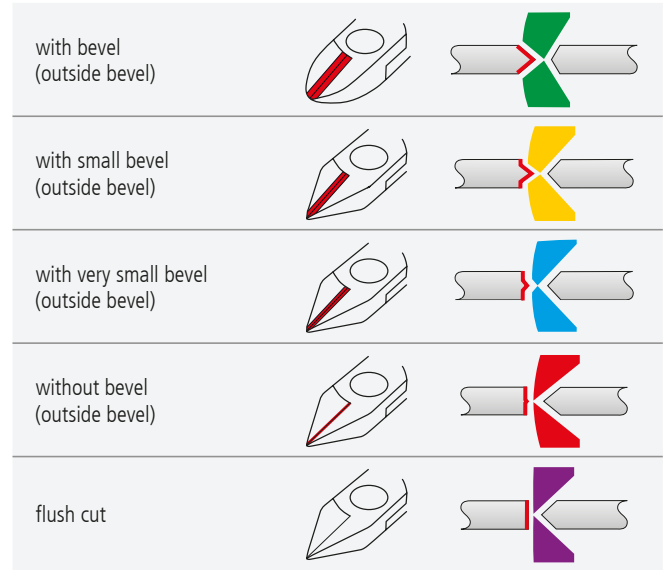

## WIRE CLASSES

	Material examples	Type of wire	Tensile strength	
			N/mm <sup>2</sup>	kp/mm <sup>2</sup>
	Copper, plastics	soft	220	22
	Nail, wire pin	medium-hard	750	75
	Wire rope strand, steel wire	hard	1800	180
	Spring steel wire	piano wire	2300	230

The maximum values indicated always stay for the performance cutting conditions, when the wire is placed as near as possible to the joint.

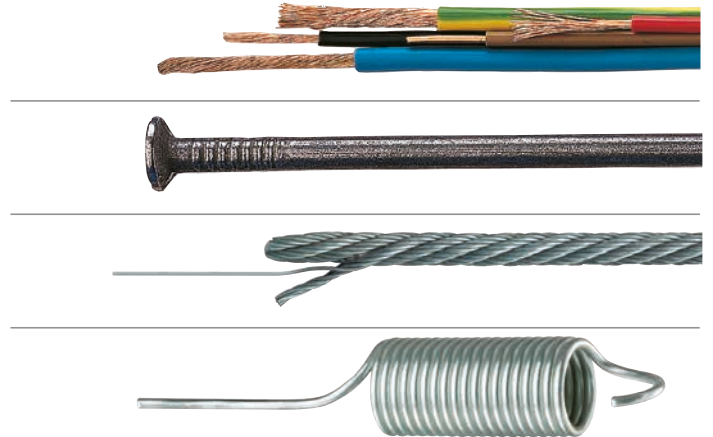

### Safety instructions

- > Each tool should only be used for its specified purpose.
- > When using cutting pliers: beware of wire ends flying off. Wear protective goggles and – if needed – gloves. Be aware of bystanders.
- > Only handles marked with the symbol 1000 V are insulated.



### Care Tips

A drop of oil on polished surfaces and in the joint will keep the tool in good working order and will increase the service life of your pliers.

# STRUCTURE OF ARTICLE NUMBER

# HEAD/HANDLES

Basic model e. g. KNIPEX Cobra® Hightech Water Pump Pliers	Form e. g. straight	Finish e. g. head polished, handles with multi- component grips	Length e. g. 250 mm	Accessory e. g. Tethered Tools range
<b>87</b>	<b>0</b>	<b>2</b>	<b>250</b>	<b>T</b>

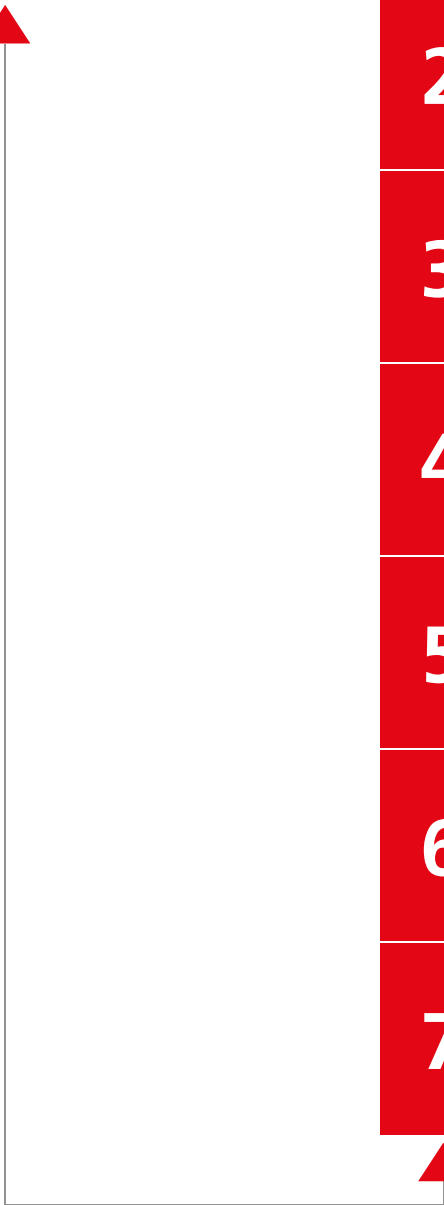

- 0**
- 1**
- 2**
- 3**
- 4**
- 5**
- 6**
- 7**

Pliers black  
atramentized,  
head polished



Head polished,  
handles plastic coated



Head polished,  
handles with  
multi-component grips



Pliers chrome plated,  
handles plastic coated



Pliers chrome plated



Pliers chrome plated,  
handles with multi-  
component grips



Pliers chrome plated,  
handles insulated with  
multi-component grips,  
VDE-tested



DIN EN 60900 / IEC 60900   1000 V

Pliers chrome plated,  
handles with dipped  
insulation,  
VDE-tested



DIN EN 60900 / IEC 60900   1000 V

# INDEX

KNIPEX CoBolt S .....	4	Snipe Nose Side Cutting Pliers .....	29
KNIPEX Cobra® XS .....	6	Grip Pliers .....	29
Pliers Wrench .....	8	KNIPEX TwistCut .....	30
KNIPEX TubiX® .....	10	Pipe Cutter .....	31
KNIPEX PreciStrip16 .....	12	Cable Shears .....	31
KNIPEX StepCut® .....	13	Cable Cutters (ratchet action) .....	32
Pipe Cutter for plastic composite pipes .....	14	Cable Cutters .....	32
Pipe Cutter for multilayer and pneumatic hoses .....	14	ACSR Cable Cutter .....	33
Siphon and Connector Pliers .....	15	Automatic Insulation Stripper .....	33
KNIPEX Cobra® QuickSet .....	15	Self-Adjusting Insulation Strippers .....	33
KNIPEX Cobra® .....	16	KNIPEX MultiStrip 10 .....	34
KNIPEX Cobra® ES .....	16	Precision Insulation Strippers .....	34
KNIPEX Mini pliers .....	16	Insulation Strippers .....	34
KNIPEX Alligator® .....	17	KNIPEX StriX® .....	35
Multiple Slip Joint Spanner .....	17	KNIPEX ErgoStrip Universal Stripping Tool .....	35
KNIPEX SmartGrip® .....	17	Cable Knife .....	36
Pliers Wrenches .....	18	Stripping Knife .....	36
Ear Clamp Pliers .....	19	Stripping Tools .....	36
Spring Hose Clamp Pliers .....	19	Automatic Stripping Pliers .....	36
Hose Clamp Pliers .....	19	KNIPEX MultiCrimp .....	37
High Leverage Combination Pliers .....	20	Crimping Pliers .....	37
Combination Pliers .....	20	KNIPEX PreciForce .....	37
Needle-Nose Combination Pliers .....	20	Self-Adjusting Crimping Pliers for wire ferrules .....	38/39
Pliers for Electrical Installation .....	21	KNIPEX Twistor®16 .....	39
Electricians' Pliers .....	21	KNIPEX TwinKey® .....	40
Diagonal Cutters .....	22	Precision Electronics Gripping Pliers .....	40
KNIPEX X-Cut® .....	22	Electronics Pliers .....	42
High Leverage Diagonal Cutters .....	23	Electronics End Cutting Nippers .....	42
KNIPEX TwinForce .....	23	Electronics Diagonal Cutters .....	43
KNIPEX CoBolt .....	24	Electronic Super Knips .....	43
KNIPEX CoBolt XL .....	24	Electronic Super Knips XL .....	43
Bolt Cutters .....	25		
Diagonal Cutters for plastics .....	25		
High Leverage Flush Cutter .....	25		
Wire Rope Cutter .....	26		
Wire Rope Cutters (forged) .....	26		
Wire Rope and ACSR-Cable Cutters .....	26		
Precision Circlip Pliers .....	27		
Circlip Pliers .....	27		
Circlip Tool .....	28		
Precision Circlip Pliers Set .....	28		
Circlip Pliers Sets .....	28		

It is not permissible to copy the catalogue or parts of it in any way without our approval.

Subject to model modifications and technical changes. Illustrations, dimensions and weights are just approximate.

No liability is assumed for misprints or errors. Printed in the Federal Republic of Germany.

KNIPEX-Werk C. Gustav Putsch KG

**KNIPEX-Werk**  
**C. Gustav Putsch KG**

42337 Wuppertal  
Germany

Tel.: +49 202 47 94-0  
Fax: +49 202 47 74 94

info@knipex.com  
www.knipex.com

Follow us on:   

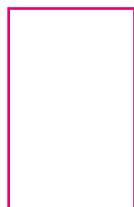

Your dealer