

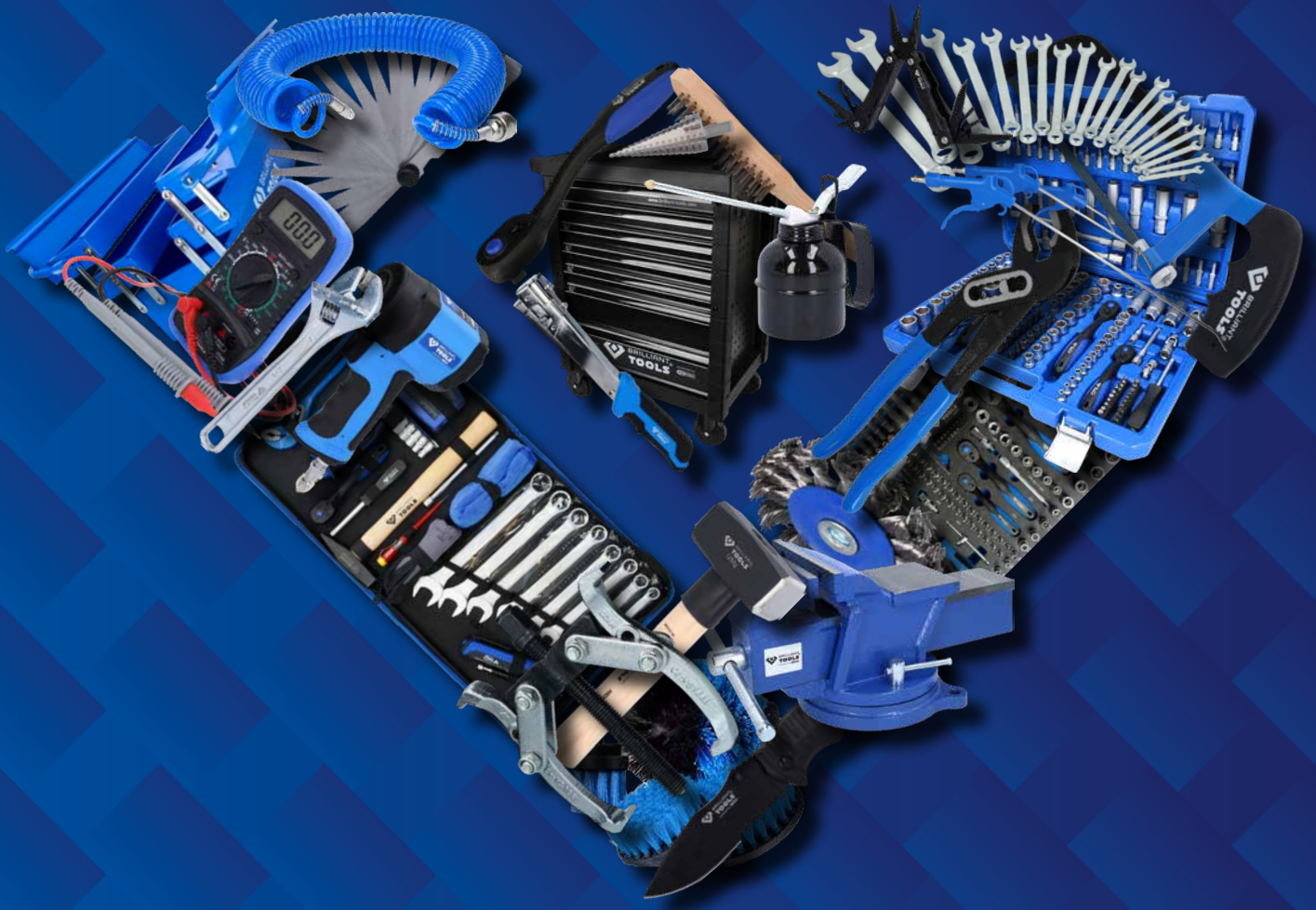

BRILLIANT<sup>®</sup>  
**TOOLS**

powered by **KSTOOLS**



**2025**



3 - 5



6 - 8



9 - 11



12 - 20



21



22 - 24



25 - 26



27



28 - 29



30 - 33



34



35



36 - 37



38



39



40 - 41



42 - 44



45 - 46



47



48



49 - 52



53 - 58



59 - 61

**BT010012**



12



BT010012	12	6 - 32 mm	€ 40,00
----------	----	-----------	---------

12 x	6 x 7 - 8 x 9 - 10 x 11 - 12 x 13 - 14 x 15 16 x 17 - 18 x 19 - 20 x 22 - 21 x 23 24 x 27 - 25 x 28 - 30 x 32 mm
------	--

**BT010900...BT010914**

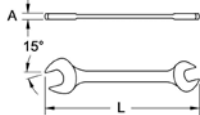

	mm	L mm	A mm	€
BT010900	6x7	105,0	3,4	2,50
BT010901	8x9	115,0	3,8	2,50
BT010902	10x11	130,0	4,4	4,00
BT010903	12x13	142,0	5,0	4,00
BT010904	14x15	152,0	5,6	4,00
BT010905	16x17	165,0	6,2	5,00
BT010907	17x19	220,0	6,8	5,00
BT010908	18x19	175,0	6,8	5,00
BT010909	20x22	190,0	7,2	6,00
BT010910	21x23	205,0	7,8	7,00
BT010912	24x27	215,0	8,4	8,00
BT010913	25x28	240,0	9,0	10,50
BT010914	30x32	260,0	9,6	11,00

**BT014804...BT014815**



	mm	L	L mm	€
BT014804	15	4"	100,0	6,00
BT014806	18	6"	150,0	8,00
BT014808	23	8"	200,0	9,00
BT014810	28	10"	250,0	11,00
BT014812	34	12"	300,0	15,00
BT014815	43	15"	375,0	28,00

**BT011015**



15



BT011015	15	6 - 22 mm	€ 36,00
----------	----	-----------	---------

15 x	6 - 7 - 8 - 9 - 10 - 11 - 12 - 13 - 14 - 15 16 - 17 - 18 - 19 - 22 mm
------	--

**BT011021**



21



BT011021	21	6 - 32 mm	€ 71,00
----------	----	-----------	---------

21 x	6 - 7 - 8 - 9 - 10 - 11 - 12 - 13 - 14 - 15 16 - 17 - 18 - 19 - 20 - 21 - 22 - 24 - 27 30 - 32 mm
------	---



**BT011906...BT011932**

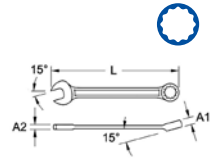

	mm	L mm	A1 mm	A2 mm	€
BT011906	6	105,0	5,2	3,5	2,50
BT011907	7	115,0	6,2	3,8	2,50
BT011908	8	130,0	6,6	4,3	2,50
BT011909	9	142,0	7,0	4,3	2,50
BT011910	10	152,0	7,8	4,6	2,50
BT011911	11	165,0	8,1	4,8	4,00
BT011912	12	175,0	9,1	5,3	4,00
BT011913	13	190,0	9,6	5,6	4,00
BT011914	14	205,0	10,2	5,9	4,00
BT011915	15	215,0	10,9	6,3	5,00
BT011916	16	227,0	11,6	6,5	5,00
BT011917	17	240,0	11,7	6,9	5,00
BT011918	18	251,0	12,8	7,1	6,00
BT011919	19	260,0	12,3	8,0	6,00
BT011920	20	275,0	13,2	7,7	7,00
BT011921	21	288,0	13,3	8,1	7,00
BT011922	22	295,0	14,8	9,0	7,00
BT011924	24	330,0	15,8	9,6	8,00
BT011927	27	360,0	17,1	10,0	10,50
BT011930	30	390,0	18,5	11,0	13,00
BT011932	32	420,0	20,1	12,0	15,00

**BT012012**



12



BT012012	12	6 - 32 mm	€ 71,00
----------	----	-----------	---------

12 x	6 x 7 - 8 x 9 - 10 x 11 - 12 x 13 - 14 x 15 16 x 17 - 18 x 19 - 20 x 22 - 21 x 23 24 x 27 - 25 x 28 - 30 x 32 mm
------	--



### BT012900...BT012911

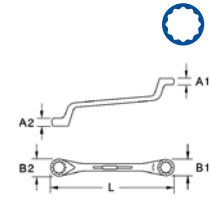

	mm	L mm	A1 mm	A2 mm	€
BT012900	6x7	176,0	6,3	5,7	4,00
BT012901	8x9	190,5	7,7	6,7	4,00
BT012902	10x11	205,0	9,2	8,6	5,00
BT012903	12x13	220,5	9,9	9,5	5,00
BT012904	14x15	236,0	10,8	10,2	6,00
BT012905	16x17	250,0	12,0	11,4	7,00
BT012906	18x19	271,0	12,8	12,4	8,00
BT012907	20x22	291,0	14,0	13,2	10,50
BT012908	21x23	310,5	14,2	13,6	11,00
BT012909	24x27	331,0	15,6	14,4	12,00
BT012910	25x28	350,0	15,6	14,6	15,00
BT012911	30x32	371,0	16,9	16,4	18,00

### BT706015



	mm	L mm	A1 mm	A2 mm	€
BT706015	6	8 - 19 mm			24,00

6 x 8 x 9 - 10 x 11 - 12 x 13 - 14 x 15 - 16 x 17 - 18 x 19 mm

### BT706016...BT706021

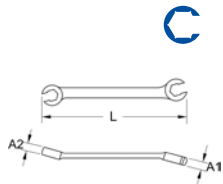

	mm	L mm	A1 mm	A2 mm	€
BT706016	8 x 9	143,0	6,5	7,5	5,00
BT706017	10 x 11	146,0	7,7	8,4	5,00
BT706018	12 x 13	165,0	8,2	9,5	6,00
BT706019	14 x 15	194,0	10,3	10,7	6,00
BT706020	16 x 17	196,0	10,7	12,3	8,00
BT706021	18 x 19	204,0	11,1	13,4	8,00

### BT016001

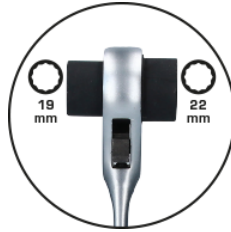

	mm	L mm	€
BT016001	19x22	315,0	21,00

### BT013901

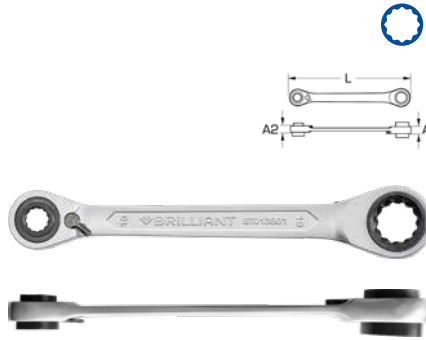

	mm	L mm	A1 mm	A2 mm	€
BT013901	10x13x17x19	220,0	20,0	17,0	13,00

### BT013105



	mm	L mm	A1 mm	A2 mm	€
BT013105	5	8 - 19 mm			36,00

5 x 8 - 10 - 13 - 17 - 19 mm

### BT013112



	mm	L mm	A1 mm	A2 mm	€
BT013112	12	8 - 19 mm			82,00

12 x 8 - 9 - 10 - 11 - 12 - 13 - 14 - 15 - 16 - 17 - 18 - 19 mm

### BT013121



	mm	L mm	A1 mm	A2 mm	€
BT013121	21	6 - 32 mm			186,00

21 x 6 - 7 - 8 - 9 - 10 - 11 - 12 - 13 - 14 - 15 - 16 - 17 - 18 - 19 - 20 - 21 - 22 - 24 - 27 - 30 - 32 mm

### BT013706...BT013732

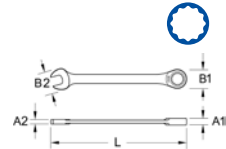

	mm	L mm	A1 mm	A2 mm	B1 mm	B2 mm	€
BT013706	6	125,0	6,5	4,2	17,3	13,5	6,00
BT013707	7	133,0	6,5	4,4	17,3	16,7	6,00

	mm	L mm	A1 mm	A2 mm	B1 mm	B2 mm	€
BT013708	8	140,0	6,5	4,6	17,3	17,1	6,00
BT013709	9	150,0	7,2	4,8	19,0	19,2	6,00
BT013710	10	159,0	7,7	5,0	21,0	21,3	6,00
BT013711	11	165,0	8,2	5,3	22,5	23,4	7,00
BT013712	12	171,0	8,6	5,6	24,2	25,4	7,00
BT013713	13	178,0	9,0	5,9	25,5	27,5	8,00
BT013714	14	191,0	9,4	6,2	27,5	29,5	8,00
BT013715	15	200,0	9,9	6,5	29,0	31,6	9,00
BT013716	16	209,0	10,3	6,8	30,8	33,6	9,00
BT013717	17	225,0	10,7	7,2	32,4	35,6	10,50
BT013718	18	237,0	11,2	7,6	33,5	37,6	10,50
BT013719	19	245,0	11,2	8,0	33,5	40,0	10,50
BT013720	20	290,0	13,0	8,6	42,2	46,0	11,00
BT013721	21	290,0	13,0	8,6	42,2	46,0	13,00
BT013722	22	290,0	13,0	8,6	42,2	46,0	13,00
BT013724	24	335,0	14,5	9,7	49,2	46,0	16,00
BT013727	27	359,0	15,5	10,7	53,2	56,5	19,00
BT013730	30	405,0	17,0	11,6	58,5	62,7	22,00
BT013732	21	425,0	17,5	12,2	62,0	66,5	23,00

**BT013221**



	€
BT013221 21 6 - 32 mm	207,00
21 x 6 - 7 - 8 - 9 - 10 - 11 - 12 - 13 - 14 - 15 - 16 - 17 - 18 - 19 - 20 - 21 - 22 - 24 - 27 - 30 - 32 mm	



**BT013806...BT013832**

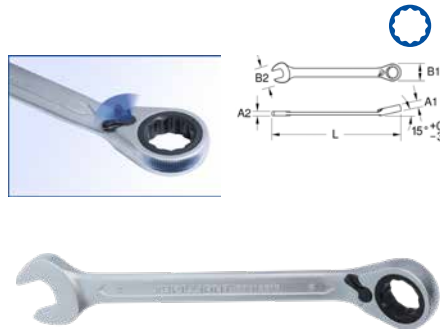

	mm	L mm	A1 mm	A2 mm	B1 mm	B2 mm	€
BT013806	6	125,0	6,5	4,2	17,3	13,5	6,00
BT013807	7	133,0	6,5	4,4	17,3	16,7	7,00
BT013808	8	140,0	6,5	5,0	18,4	18,0	7,00
BT013809	9	150,0	7,2	5,2	19,4	20,0	8,00
BT013810	10	159,0	7,7	5,7	21,4	23,0	8,00
BT013811	11	165,0	8,2	6,3	23,3	25,0	8,00
BT013812	12	171,0	8,6	6,7	24,8	27,0	8,00
BT013813	13	178,0	9,0	7,0	26,4	28,0	9,00
BT013814	14	191,0	9,4	7,5	28,1	32,0	10,50
BT013815	15	200,0	9,9	8,0	30,3	33,0	10,50
BT013816	16	209,0	10,3	8,0	32,0	35,0	10,50
BT013817	17	225,0	10,7	8,7	34,0	38,5	10,50
BT013818	18	237,0	11,2	9,0	35,3	39,0	11,00
BT013819	19	245,0	11,2	9,5	36,1	42,0	12,00
BT013820	20	290,0	13,0	9,7	42,3	46,0	13,00
BT013821	21	290,0	13,0	9,7	42,3	46,0	15,00
BT013822	22	290,0	13,0	9,7	42,3	46,0	17,00
BT013824	24	335,0	14,5	10,7	49,2	52,3	20,00
BT013827	27	359,0	15,5	11,6	53,2	56,5	25,00
BT013830	30	405,0	17,0	12,5	58,6	62,7	26,00
BT013832	32	425,0	17,5	13,1	62,0	66,5	27,00

**BT015100**

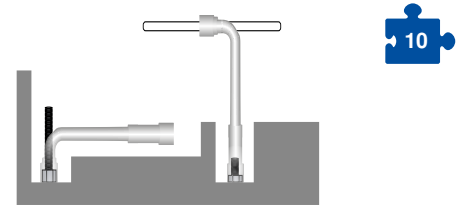

	€
BT015100 10 8 - 19 mm	61,00
10 x 8 - 10 - 11 - 12 - 13 - 14 - 16 - 17 - 18 - 19 mm	

**BT015006...BT015024**



	mm	L mm	D mm	€
BT015006	6	113,0	11,7	4,00
BT015007	7	118,0	11,7	4,00
BT015008	8	118,0	11,7	4,00
BT015009	9	130,0	14,7	4,00
BT015010	10	132,0	14,7	5,00
BT015011	11	144,0	16,7	5,00
BT015012	12	150,0	17,8	5,00
BT015013	13	160,0	18,6	5,00
BT015014	14	170,0	19,8	6,00
BT015015	15	185,0	21,5	7,00
BT015016	16	195,0	21,5	7,00
BT015017	17	202,0	23,9	7,00
BT015018	18	212,0	25,7	8,00
BT015019	19	218,0	25,7	8,00
BT015020	20	230,0	30,7	9,00
BT015021	21	241,0	30,7	9,00
BT015022	22	252,0	30,7	10,50
BT015023	23	265,0	33,2	11,00
BT015024	24	275,0	33,2	11,00

**BT013205**



	€
BT013205 5 8 - 19 mm	40,00
5 x 8 - 10 - 13 - 17 - 19 mm	

**BT013212**



	€
BT013212 12 8 - 19 mm	92,00
12 x 8 - 9 - 10 - 11 - 12 - 13 - 14 - 15 - 16 - 17 - 18 - 19 mm	



### BT020023



23  
1/4"  
6,3 mm



		€
BT020023	23	1/4" 6,3 mm 22,00

12 x		4 - 4,5 - 5 - 5,5 - 6 - 7 - 8 - 9 - 10 - 11 12 - 13 mm
1 x		110 mm
1 x		100 mm
1 x		1/4" x 1/4"
2 x		PH1 - PH2
2 x		PZ1 - PZ2
4 x		T15 - T20 - T25 - T30

### BT020046



46  
1/4"  
6,3 mm



		€
BT020046	46	1/4" 6,3 mm 26,00

13 x		4 - 4,5 - 5 - 5,5 - 6 - 7 - 8 - 9 - 10 - 11 12 - 13 - 14 mm
3 x		4 - 5,5 - 7 mm
3 x		PH1 - PH2 - PH3
2 x		PZ1 - PZ2
5 x		4 - 5 - 6 - 7 - 8 mm
7 x		T10 - T15 - T20 - T25 - T27 - T30 - T40
1 x		110 mm
1 x		150 mm
1 x		110 mm
2 x		50 - 100 mm
1 x		150 mm
1 x		1/4" x 1/4"
1 x		1/4" x 1/4"
4 x		1 - 1,5 - 2 - 2,5 mm

### BT020930...BT020942



1/4"  
6,3 mm



	mm	L mm	€
BT020930	4,0	25,0	2,50
BT020931	4,5	25,0	2,50
BT020932	5,0	25,0	2,50
BT020933	5,5	25,0	2,50
BT020934	6,0	25,0	2,50
BT020935	7,0	25,0	2,50
BT020936	8,0	25,0	2,50
BT020937	9,0	25,0	2,50
BT020938	10,0	25,0	2,50
BT020939	11,0	25,0	2,50
BT020940	12,0	25,0	2,50
BT020941	13,0	25,0	2,50
BT020942	14,0	25,0	2,50



### BT020950...BT020959



1/4"  
6,3 mm



	mm	L mm	€
BT020950	4,0	50,0	2,50
BT020951	5,0	50,0	2,50
BT020952	6,0	50,0	2,50
BT020953	7,0	50,0	2,50
BT020954	8,0	50,0	2,50
BT020955	9,0	50,0	2,50
BT020956	10,0	50,0	2,50
BT020957	11,0	50,0	2,50
BT020958	12,0	50,0	2,50
BT020959	13,0	50,0	2,50

### BT020960...BT020965



1/4"  
6,3 mm



		L mm	€
BT020960	E4	25,0	2,50
BT020961	E5	25,0	2,50
BT020962	E6	25,0	2,50
BT020963	E7	25,0	2,50
BT020964	E8	25,0	2,50
BT020965	E10	25,0	2,50

### BT020899



1/4"  
6,3 mm



	mm	L mm	€
BT020899	5 - 14	40,0	12,00

**BT020810...BT020813**



1/4"  
6,3 mm



	mm	L mm	€
BT020810	4,0	38,0	2,50
BT020811	5,5	38,0	2,50
BT020812	6,5	38,0	2,50
BT020813	7,0	38,0	2,50

**BT020820...BT020825**



1/4"  
6,3 mm



	mm	L mm	€
BT020820	3,0	38,0	2,50
BT020821	4,0	38,0	2,50
BT020822	5,0	38,0	2,50
BT020823	6,0	38,0	2,50
BT020824	7,0	38,0	2,50
BT020825	8,0	38,0	2,50

**BT020906**



1/4"  
6,3 mm



		L mm	€
BT020906	1/4" 6,3 mm	40,0	5,00

**BT020909**

**BT020990...BT020993**



1/4"  
6,3 mm



		L mm	€
BT020990	PH0	38,0	2,50
BT020991	PH1	38,0	2,50
BT020992	PH2	38,0	2,50
BT020993	PH3	38,0	2,50

**BT020970...BT020976**



1/4"  
6,3 mm



		L mm	€
BT020970	T9	38,0	2,50
BT020971	T10	38,0	2,50
BT020972	T15	38,0	2,50
BT020973	T20	38,0	2,50
BT020974	T25	38,0	2,50
BT020975	T30	38,0	2,50
BT020976	T40	38,0	2,50

1/4"  
6,3 mm



		L mm	€
BT020909	1/4" 6,3 mm	30,0	1,50

**BT020911**



1/4"  
6,3 mm



		L mm	€
BT020911	3/8" 10 mm	29,0	2,50

**BT020800...BT020803**



1/4"  
6,3 mm



		L mm	€
BT020800	PZ0	38,0	2,50
BT020801	PZ1	38,0	2,50
BT020802	PZ2	38,0	2,50
BT020803	PZ3	38,0	2,50

**BT020980...BT020986**



1/4"  
6,3 mm



		L mm	€
BT020980	TB9	38,0	2,50
BT020981	TB10	38,0	2,50
BT020982	TB15	38,0	2,50
BT020983	TB20	38,0	2,50
BT020984	TB25	38,0	2,50
BT020985	TB27	38,0	2,50
BT020986	TB30	38,0	2,50

**BT020912**



1/4"  
6,3 mm



		L mm	€
BT020912	1/4" 6,3 mm	25,0	2,50

**BT020907...BT020908**

 1/4"  
6,3 mm

	■	L mm	€
BT020907	1/4" 6,3 mm	50,0	2,50
BT020908	1/4" 6,3 mm	100,0	4,00

**BT020903...BT020905**

 1/4"  
6,3 mm

	■	L mm	€
BT020903	1/4" 6,3 mm	35,0	2,50
BT020904	1/4" 6,3 mm	75,0	4,00
BT020905	1/4" 6,3 mm	250,0	6,00

**BT020009**

9

 1/4"  
6,3 mm

 1/2"  
12,5 mm

 1/2"  
12,5 mm

	■	€
BT020009	9 1/4" 6,3 mm + 3/8" 10 mm + 1/2" 12,5 mm	32,00
3 x	50 - 100 - 250 mm	
3 x	75 - 150 - 250 mm	
3 x	50 - 125 - 250 mm	

**BT020910**

 1/4"  
6,3 mm

	■	L mm	€
BT020910	1/4" 6,3 mm	145,0	4,00

**BT020901**

 1/4"  
6,3 mm

	■	L mm	€
BT020901	1/4" 6,3 mm	150,0	4,00

**BT020902**

 1/4"  
6,3 mm

	■	L mm	€
BT020902	1/4" 6,3 mm	110,0	2,50

**BT020900**

 1/4"  
6,3 mm

	■	L mm	€
BT020900	1/4" 6,3 mm	150,0	13,00

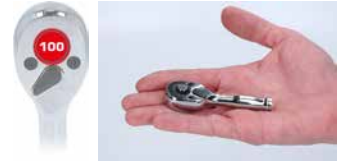
**BT020999**

 1/4"  
6,3 mm

	■	L mm	€
BT020999	1/4" 6,3 mm	86,0	13,00

**BT020995**

 1/4"  
6,3 mm

	■	L mm	€
BT020995	1/4" 6,3 mm	150,0	17,00

**BT020996**

 1/4"  
6,3 mm

	■	L mm	€
BT020996	1/4" 6,3 mm	150 - 200	19,00

**BT020997**

 1/4"  
6,3 mm

	■	L mm	€
BT020997	1/4" 6,3 mm	175 - 225	24,00

**BT021061**



61  
3/8"  
10,0 mm



	61	3/8" 10 mm	€
18 x		6 - 7 - 8 - 9 - 10 - 11 - 12 - 13 - 14 - 15 16 - 17 - 18 - 19 - 20 - 21 - 22 - 24 mm	
10 x		8 - 9 - 10 - 11 - 12 - 13 - 14 - 15 - 17 19 mm	
2 x		16 - 21 mm	
3 x		5,5 - 7 - 8 mm	
3 x		PH1 - PH2 - PH3	
3 x		PZ1 - PZ2 - PZ3	
7 x		3 - 4 - 5 - 6 - 7 - 8 - 10 mm	
9 x		T15 - T20 - T25 - T27 - T30 - T40 T45 - T50 - T55	
1 x		198 mm	
2 x		75 - 250 mm	
1 x		3/8" x 3/8"	
1 x		3/8" x 3/8"	
1 x		3/8" x 3/8"	

**BT021800...BT021817**



3/8"  
10,0 mm



	mm	L mm	€
BT021800	6,0	28,0	4,00
BT021801	7,0	28,0	4,00
BT021802	8,0	28,0	4,00
BT021803	9,0	28,0	4,00
BT021804	10,0	28,0	4,00
BT021805	11,0	28,0	4,00
BT021806	12,0	28,0	4,00
BT021807	13,0	28,0	4,00
BT021808	14,0	28,0	4,00
BT021809	15,0	28,0	4,00
BT021810	16,0	28,0	4,00
BT021811	17,0	28,0	4,00
BT021812	18,0	28,0	4,00
BT021813	19,0	28,0	4,00
BT021814	20,0	28,0	5,00
BT021815	21,0	28,0	5,00
BT021816	22,0	28,0	5,00
BT021817	24,0	28,0	6,00



**BT021820...BT021829**



3/8"  
10,0 mm



	mm	L mm	€
BT021820	8,0	63,0	5,00
BT021821	9,0	63,0	5,00
BT021822	10,0	63,0	5,00
BT021823	11,0	63,0	5,00
BT021824	12,0	63,0	5,00
BT021825	13,0	63,0	5,00
BT021826	14,0	63,0	5,00
BT021827	15,0	63,0	5,00
BT021828	17,0	63,0	5,00
BT021829	19,0	63,0	6,00

**BT021850...BT021852**



3/8"  
10,0 mm



	mm	L mm	€
BT021850	16,0	66,0	5,00
BT021851	18,0	66,0	5,00
BT021852	21,0	66,0	6,00

**BT021830...BT021841**



3/8"  
10,0 mm



		L mm	€
BT021830	E4	28,0	4,00
BT021831	E5	28,0	4,00
BT021832	E6	28,0	4,00
BT021833	E7	28,0	4,00
BT021834	E8	28,0	4,00
BT021835	E10	28,0	4,00
BT021836	E11	28,0	4,00
BT021837	E12	28,0	4,00
BT021838	E14	28,0	4,00
BT021839	E16	28,0	4,00
BT021840	E18	28,0	4,00
BT021841	E20	28,0	5,00

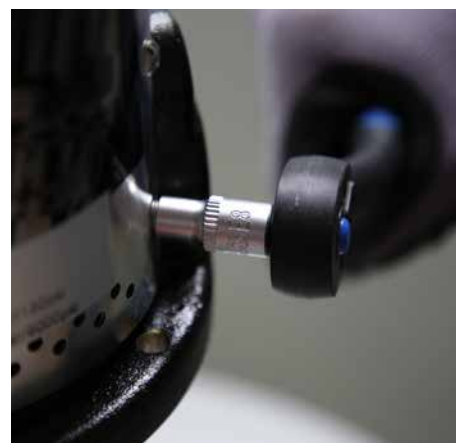

**BT021899**

 3/8"  
10,0 mm

	mm	L mm	€
BT021899	7 - 19	55,0	19,00

**BT021860...BT021862**

 3/8"  
10,0 mm

	mm	L mm	€
BT021860	5,5	49,0	4,00
BT021861	7,0	49,0	4,00
BT021862	8,0	49,0	4,00

**BT021890...BT021892**

 3/8"  
10,0 mm

		L mm	€
BT021890	PH 1	49,0	4,00
BT021891	PH 2	49,0	4,00
BT021892	PH 3	49,0	4,00

**BT021880...BT021882**

 3/8"  
10,0 mm

		L mm	€
BT021880	PZ 1	49,0	4,00
BT021881	PZ 2	49,0	4,00
BT021882	PZ 3	49,0	4,00

**BT021870...BT021876**

 3/8"  
10,0 mm

	mm	L mm	€
BT021870	3,0	49,0	4,00
BT021871	4,0	49,0	4,00
BT021872	5,0	49,0	4,00
BT021873	6,0	49,0	4,00
BT021874	7,0	49,0	5,00
BT021875	8,0	49,0	5,00
BT021876	10,0	49,0	5,00

**BT021940...BT021949**

 3/8"  
10,0 mm

		L mm	€
BT021940	T15	49,0	4,00
BT021941	T20	49,0	4,00
BT021942	T25	49,0	4,00
BT021943	T27	49,0	4,00
BT021944	T30	49,0	4,00
BT021945	T40	49,0	4,00
BT021946	T45	49,0	4,00
BT021947	T47	49,0	4,00
BT021948	T50	49,0	5,00
BT021949	T55	49,0	5,00

**BT021930...BT021932**

 3/8"  
10,0 mm

		L mm	€
BT021930	TB40	48,0	4,00
BT021931	TB45	48,0	4,00
BT021932	TB50	48,0	5,00

**BT021901**

 3/8"  
10,0 mm

		L mm	€
BT021901	3/8" 10 mm	40,0	4,00

**BT021902**

 3/8"  
10,0 mm

		L mm	€
BT021902	3/8" 10 mm	50,0	6,00

**BT021903**

 3/8"  
10,0 mm

			L mm	€
BT021903	3/8" 10 mm	5/16"	28,0	4,00

**BT021904**



3/8"  
10,0 mm

	■	□	L mm	€		
BT021904	1/2"	12,5 mm	3/8"	10 mm	36,0	4,00

**BT021905**



3/8"  
10,0 mm

	■	□	L mm	€		
BT021905	1/2"	12,5 mm	3/8"	10 mm	27,0	2,50

**BT021907...BT021909**



3/8"  
10,0 mm



	■	L mm	€	
BT021907	3/8"	10 mm	75,0	4,00
BT021908	3/8"	10 mm	125,0	5,00
BT021909	3/8"	10 mm	250,0	6,00



**BT021910...BT021912**



3/8"  
10,0 mm



	■	L mm	€	
BT021910	3/8"	10 mm	35,0	4,00
BT021911	3/8"	10 mm	75,0	5,00
BT021912	3/8"	10 mm	250,0	7,00

**BT020009**



9



1/4"  
6,3 mm

1/2"  
12,5 mm

1/2"  
12,5 mm



	■	■	€
BT020009	9	1/4" 6,3 mm + 3/8" 10 mm + 1/2" 12,5 mm	32,00

3 x		50 - 100 - 250 mm
3 x		75 - 150 - 250 mm
3 x		50 - 125 - 250 mm

**BT021900**



3/8"  
10,0 mm



	■	L mm	€	
BT021900	3/8"	10 mm	198,0	19,00

**BT021995**



3/8"  
10,0 mm



	■	L mm	€	
BT021995	3/8"	10 mm	200,0	22,00

**BT021996**



3/8"  
10,0 mm



	■	L mm	€	
BT021996	3/8"	10 mm	220 - 320	22,00



**BT021997**



3/8"  
10,0 mm



	■	L mm	€	
BT021997	3/8"	10 mm	250 - 350	23,00



### BT022025



25  
1/2"  
12,5 mm



		€
BT022025	25	1/2" 12,5 mm 54,00

18 x		10 - 11 - 12 - 13 - 14 - 15 - 16 - 17 - 18 19 - 20 - 21 - 22 - 23 - 24 - 27 - 30 - 32 mm
2 x		16 - 21 mm
1 x		250 mm
1 x		250 mm
2 x		125 - 250 mm
1 x		1/2" x 1/2"

### BT023094



94  
1/4"  
6,3 mm  
1/2"  
12,5 mm



		€
BT023094	94	1/4" 6,3 mm + 1/2" 12,5 mm 78,00

13 x		4 - 4,5 - 5 - 5,5 - 6 - 7 - 8 - 9 - 10 - 11 12 - 13 - 14 mm
8 x		6 - 7 - 8 - 9 - 10 - 11 - 12 - 13 mm
3 x		4 - 5,5 - 7 mm
2 x		PH1 - PH2
2 x		PZ1 - PZ2
4 x		3 - 4 - 5 - 6 mm
5 x		T10 - T15 - T20 - T25 - T30
1 x		150 mm
1 x		150 mm
1 x		110 mm
2 x		50 - 100 mm
1 x		145 mm
1 x		1/4" x 1/4"
1 x		1/4" x 1/4"
18 x		10 - 11 - 12 - 13 - 14 - 15 - 16 - 17 - 18 19 - 20 - 21 - 22 - 23 - 24 - 27 - 30 - 32 mm
4 x		14 - 15 - 17 - 19 mm
2 x		16 - 21 mm
1 x		250 mm
2 x		125 - 250 mm
1 x		3/8" x 1/2"
1 x		1/2" x 1/2"
1 x		1/2" x 5/16"
3 x		8 - 10 - 12 mm
2 x		PH3 - PH4
2 x		PZ3 - PZ4
4 x		8 - 10 - 12 - 14 mm
4 x		T40 - T45 - T50 - T55
3 x		1,5 - 2 - 2,5 mm

### BT023172



172  
1/4"  
6,3 mm  
3/8"  
10,0 mm  
1/2"  
12,5 mm



		€
BT023172	172	1/4" 6,3 mm + 3/8" 10 mm + 1/2" 12,5 mm 82,00

13 x		4 - 4,5 - 5 - 5,5 - 6 - 7 - 8 - 9 - 10 - 11 12 - 13 - 14 mm
7 x		4 - 5 - 6 - 7 - 8 - 9 - 10 mm
5 x		E4 - E5 - E6 - E7 - E8
4 x		4 - 5,5 - 6,5 - 7 mm
3 x		PH0 - PH1 - PH2
3 x		PZ0 - PZ1 - PZ2
4 x		3 - 4 - 5 - 6 mm
8 x		T8 - T9 - T10 - T15 - T20 - T25 - T27 T30
8 x		TB8 - TB9 - TB10 - TB15 - TB20 TB25 - TB27 - TB30
1 x		150 mm
1 x		150 mm
1 x		110 mm
2 x		50 - 100 mm
1 x		1/4" x 1/4"
1 x		1/4" x 1/4"
10 x		10 - 11 - 12 - 13 - 14 - 15 - 16 - 17 18 - 19 mm
6 x		10 - 11 - 12 - 13 - 14 - 15 mm
1 x		18 mm
6 x		E10 - E11 - E12 - E14 - E16 - E18
1 x		198 mm
1 x		125 mm
1 x		3/8" x 3/8"
1 x		3/8" x 5/16"
17 x		10 - 11 - 12 - 13 - 14 - 15 - 16 - 17 - 18 19 - 20 - 21 - 22 - 23 - 24 - 27 - 30 - 32 mm
5 x		16 - 17 - 18 - 19 - 22 mm
2 x		16 - 21 mm
2 x		E20 - E24
1 x		250 mm
2 x		125 - 250 mm
1 x		3/8" x 1/2"
1 x		1/2" x 1/2"
1 x		1/2" x 5/16"
3 x		T5 - T6 - T7
9 x		TB7 - TB10 - TB15 - TB20 - TB25 TB27 - TB30 - TB40 - TB45
3 x		M5 - M6 - M8
5 x		M5 - M6 - M7 - M8 - M9
3 x		8 - 10 - 12 mm
2 x		PH3 - PH4
2 x		PZ3 - PZ4
5 x		7 - 8 - 10 - 12 - 14 mm
6 x		T40 - T45 - T50 - T55 - T60 - T70
6 x		TB40 - TB45 - TB50 - TB55 - TB60 TB70
7 x		1,5 - 2 - 2,5 - 3 - 4 - 5 - 6 mm

**BT023216**



216

1/4"  
6,3 mm

3/8"  
10,0 mm

1/2"  
12,5 mm



BT023216	216	1/4" 6,3 mm + 3/8" 10 mm + 1/2" 12,5 mm	€ 134,00
----------	-----	---	----------

13 x		4 - 4,5 - 5 - 5,5 - 6 - 7 - 8 - 9 - 10 - 11 - 12 - 13 - 14 mm
7 x		4 - 5 - 6 - 7 - 8 - 9 - 10 mm
5 x		E4 - E5 - E6 - E7 - E8
4 x		4 - 5,5 - 6,5 - 7 mm
3 x		PH0 - PH1 - PH2
3 x		PZ0 - PZ1 - PZ2
4 x		3 - 4 - 5 - 6 mm
8 x		T8 - T9 - T10 - T15 - T20 - T25 - T27 - T30
8 x		TB8 - TB9 - TB10 - TB15 - TB20 - TB25 - T27 - TB30
1 x		150 mm
1 x		205 mm
1 x		150 mm
1 x		110 mm
1 x		1/4" x 1/4"
2 x		50 - 100 mm
1 x		1/4" x 1/4"
1 x		1/4" x 1/4"
10 x		10 - 11 - 12 - 13 - 14 - 15 - 16 - 17 - 18 - 19 mm
6 x		10 - 11 - 12 - 13 - 14 - 15 mm
1 x		18 mm
6 x		E10 - E11 - E12 - E14 - E16 - E18
1 x		3/8" 198 mm
1 x		3/8" x 3/8"
1 x		125 mm
1 x		3/8" x 5/16"
14 x		13 - 14 - 15 - 16 - 17 - 18 - 19 - 20 - 21 - 22 - 24 - 27 - 30 - 32 mm
5 x		16 - 17 - 18 - 19 - 22 mm
2 x		16 - 21 mm
3 x		E20 - E22 - E24

1 x		14 mm
1 x		T70
1 x		250 mm
1 x		1/2" x 1/2"
2 x		125 - 250 mm
1 x		3/8" x 1/2"
1 x		1/2" x 5/16"
6 x		2 - 2,5 - 3 - 4 - 5 - 6 mm
3 x		T5 - T6 - T7
9 x		TB7 - TB10 - TB15 - TB20 - TB25 - TB27 - TB30 - TB40 - TB45
3 x		M5 - M6 - M8
5 x		M5 - M6 - M7 - M8 - M9
4 x		#0 - #1 - #2 - #3
4 x		4 - 6 - 8 - 10 mm
4 x		#1 - #2 - #3 - #4
3 x		#6 - #8 - #10
3 x		#1 - #2 - #3
3 x		8 - 10 - 12 mm
3 x		PH2 - PH3 - PH4
3 x		PZ2 - PZ3 - PZ4
4 x		7 - 8 - 10 - 12 mm
5 x		T40 - T45 - T50 - T55 - T60
5 x		TB40 - TB45 - TB50 - TB55 - TB60
2 x		M10 - M12
4 x		M10 - M11 - M12 - M13
1 x		TS50
7 x		1,3 - 1,5 - 2 - 2,5 - 3 - 4 - 5 mm
12 x		8 - 9 - 10 - 11 - 12 - 13 - 14 - 15 - 16 - 17 - 18 - 19 mm

**BT024064**



58

1/4"  
6,3 mm



BT024064	58	1/4" 6,3 mm	€ 83,00
----------	----	-------------	---------

7 x		7 - 8 - 9 - 10 - 11 - 12 - 13 mm
1 x		150 mm
1 x		150 mm
1 x		150 mm
1 x		1/4" x 1/4"
1 x		1/4" x 1/4"
4 x		4 - 5 - 6,5 - 8 mm
4 x		PH1 - 2 x PH2 - PH3
4 x		PZ1 - 2 x PZ2 - PZ3
4 x		3 - 4 - 5 - 6 mm
7 x		T10 - T15 - T20 - T25 - T27 - T30 - T40
7 x		TB10 - TB15 - TB20 - TB25 - TB27 - TB30 - TB40
7 x		12 - 14 - 15 - 16 - 17 - 19 - 21 mm
1 x		60 mm
1 x		4 x 0,8 mm
1 x		250 mm
1 x		160 mm
1 x		133 - 645 mm
1 x		300 mm
1 x		6 + 1 SMD/ 40 Lumen
1 x		L
1 x		400 x 300 mm

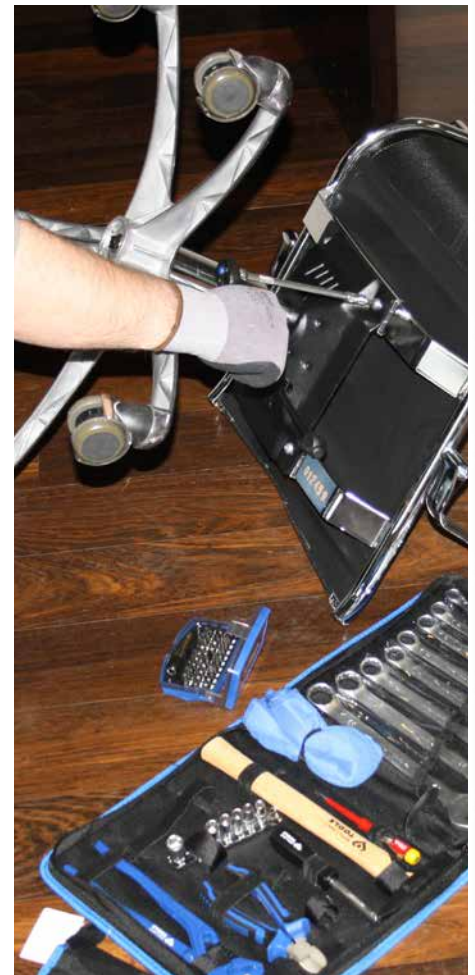



### BT024095



**95**  
1/4"  
6,3 mm  
1/2"  
12,5 mm



BT024095	95	1/4" 6,3 mm + 1/2" 12,5 mm	€ 155,00
----------	----	----------------------------	----------

12 x		4 - 4,5 - 5 - 5,5 - 6 - 7 - 8 - 9 - 10 - 11 - 12 - 13 mm
3 x		4 - 5,5 - 6,5 mm
3 x		PH0 - PH1 - PH2
3 x		PZ0 - PZ1 - PZ2
4 x		3 - 4 - 5 - 6 mm
6 x		T9 - T10 - T15 - T20 - T25 - T30
1 x		1/4" 150 mm
1 x		1/4" 100 mm
1 x		1/4" x 1/4"
16 x		10 - 11 - 12 - 13 - 14 - 15 - 16 - 17 - 19 - 20 - 21 - 22 - 24 - 27 - 30 - 32 mm
1 x		1/2" 250 mm
1 x		1/2" 125 mm
1 x		1/2" x 1/2"
9 x		1,5 - 2 - 2,5 - 3 - 4 - 5 - 6 - 8 - 10 mm
9 x		T10 - T15 - T20 - T25 - T27 - T30 - T40 - T45 - T50
12 x		8 - 9 - 10 - 11 - 12 - 13 - 14 - 15 - 16 - 17 - 18 - 19 mm
4 x		3 - 4 - 5,5 - 6,5 mm
3 x		PH0 - PH1 - PH2
1 x		160 mm
1 x		200 mm
1 x		300 mm
1 x		160 mm

### BT024143



**143**  
1/4"  
6,3 mm  
1/2"  
12,5 mm



BT024143	143	1/4" 6,3 mm + 1/2" 12,5 mm	€ 258,00
----------	-----	----------------------------	----------

12 x		4 - 4,5 - 5 - 5,5 - 6 - 7 - 8 - 9 - 10 - 11 - 12 - 13 mm
1 x		1/4" 150 mm
1 x		1/4" 150 mm
2 x		50 - 100 mm
1 x		1/4" x 1/4"
16 x		10 - 11 - 12 - 13 - 14 - 15 - 16 - 17 - 19 - 20 - 21 - 22 - 24 - 27 - 30 - 32 mm
1 x		1/2" 250 mm
2 x		1/2" 125 - 250 mm
1 x		1/2" x 1/2"
32 x		3 - 4 - 5 - 6 mm
		PH1 - PH2 - PH3
		PZ1 - PZ2 - PZ3
		T10 - T15 - T20 - T25 - T27 - T30 - T40
9 x		3 - 4 - 5 - 6 mm
		1,5 - 2 - 2,5 - 3 - 4 - 5 - 6 - 8 - 10 mm
9 x		T10 - T15 - T20 - T25 - T27 - T30 - T40 - T45 - T50
12 x		8 - 9 - 10 - 11 - 12 - 13 - 14 - 15 - 16 - 17 - 18 - 19 mm
4 x		3 - 4 - 5,5 - 6,5 mm
3 x		PH0 - PH1 - PH2
1 x		4 mm
1 x		160 mm
1 x		180 mm
1 x		200 mm

1 x		250 mm
1 x		140 mm
1 x		160 mm
1 x		300 mm
1 x		300 mm
1 x		200 mm
1 x		0 - 150 mm
1 x		133 - 645 mm
1 x		3 m
1 x		150 mm
1 x		150 mm
1 x		120 mm
6 x		Ø 2 - 3 - 4 - 5 - 6 - 8 mm
2 x		Hieb 2
3 x		
1 x		6+1 SMD / 40 Lumen

### BT022800...BT022818



1/2"  
12,5 mm



	mm	L mm	€
BT022800	8,0	38,0	5,00
BT022801	10,0	38,0	5,00
BT022802	11,0	38,0	5,00
BT022803	12,0	38,0	5,00
BT022804	13,0	38,0	5,00
BT022805	14,0	38,0	5,00
BT022806	15,0	38,0	5,00
BT022807	16,0	38,0	5,00
BT022808	17,0	38,0	5,00
BT022809	18,0	38,0	6,00
BT022810	19,0	38,0	6,00
BT022811	20,0	38,0	6,00
BT022812	21,0	38,0	6,00
BT022813	22,0	38,0	6,00
BT022814	23,0	38,0	7,00
BT022815	24,0	38,0	7,00
BT022816	27,0	38,0	7,00
BT022817	30,0	38,0	8,00
BT022818	32,0	38,0	8,00



**BT022820...BT022830**



1/2"  
12,5 mm



	mm	L mm	€
BT022820	10,0	77,0	7,00
BT022821	11,0	77,0	7,00
BT022822	12,0	77,0	7,00
BT022823	13,0	77,0	7,00
BT022824	14,0	77,0	7,00
BT022825	15,0	77,0	7,00
BT022826	16,0	77,0	7,00
BT022827	17,0	77,0	7,00
BT022828	18,0	77,0	7,00
BT022829	19,0	77,0	7,00
BT022830	22,0	77,0	8,00



**BT022850...BT022851**



1/2"  
12,5 mm



	mm	L mm	€
BT022850	16,0	77,0	6,00
BT022851	21,0	77,0	6,00

**BT022408...BT022436**



1/2"  
12,5 mm



	mm	L mm	€
BT022408	8,0	38,0	6,00
BT022409	9,0	38,0	6,00
BT022410	10,0	38,0	6,00
BT022411	11,0	38,0	6,00
BT022412	12,0	38,0	6,00
BT022413	13,0	38,0	6,00
BT022414	14,0	38,0	6,00
BT022415	15,0	38,0	6,00
BT022416	16,0	38,0	6,00
BT022417	17,0	38,0	6,00
BT022418	18,0	38,0	6,00
BT022419	19,0	38,0	6,00
BT022420	20,0	38,0	6,00
BT022421	21,0	38,0	6,00
BT022422	22,0	38,0	6,00
BT022424	24,0	38,0	7,00
BT022427	27,0	38,0	8,00
BT022430	30,0	38,0	9,00
BT022432	32,0	38,0	10,50
BT022434	34,0	38,0	11,00
BT022436	36,0	38,0	11,00

**BT022405**

21

1/2"  
12,5 mm



	mm	€
BT022405	21 1/2" 12,5 mm 8 - 36 mm	66,00

21 x 8 - 9 - 10 - 11 - 12 - 13 - 14 - 15 - 16  
17 - 18 - 19 - 20 - 21 - 22 - 24 - 27  
30 - 32 34 - 36 mm



**BT022899**



1/2"  
12,5 mm



	mm	L mm	€
BT022899	11 - 32	85,0	26,00

**BT022003**

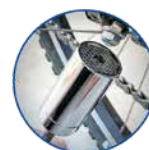

3

1/4"  
6,3 mm

3/8"  
10,0 mm

1/2"  
12,5 mm



	mm	€
BT022003	3 1/4" 6,3 mm + 3/8" 10 mm + 1/2" 12,5 mm	36,00

1 x	5 - 14 mm
1 x	7 - 19 mm
1 x	11 - 32 mm

**BT022840...BT022848**



1/2"  
12,5 mm



	L mm	€
BT022840	E10 38,0	6,00
BT022841	E11 38,0	6,00
BT022842	E12 38,0	6,00
BT022843	E14 38,0	6,00
BT022844	E16 38,0	6,00
BT022845	E18 38,0	6,00
BT022846	E20 38,0	6,00
BT022847	E22 38,0	6,00
BT022848	E24 38,0	7,00

**BT022860...BT022869**

 1/2"  
12,5 mm

	mm	L mm	€
BT022860	5,0	55,0	6,00
BT022861	6,0	55,0	6,00
BT022862	7,0	55,0	6,00
BT022863	8,0	55,0	6,00
BT022864	10,0	55,0	6,00
BT022865	12,0	55,0	6,00
BT022866	14,0	55,0	7,00
BT022868	16,0	55,0	8,00
BT022867	17,0	55,0	8,00
BT022869	18,0	55,0	9,00
BT022868	19,0	55,0	9,00
BT022869	22,0	55,0	10,50

**BT022012**

12

 1/2"  
12,5 mm

	12	1/2" 12,5 mm	5 - 22 mm	€
BT022012				44,00

12 x		5 - 6 - 7 - 8 - 10 - 12 - 14 - 16 - 17 - 18 19 - 22 mm
------	--	---

**BT022870...BT022877**

 1/2"  
12,5 mm

	mm	L mm	€
BT022870	5,0	100,0	6,00
BT022871	6,0	100,0	6,00
BT022872	7,0	100,0	6,00
BT022873	8,0	100,0	6,00
BT022874	10,0	100,0	6,00
BT022875	11,0	100,0	7,00
BT022876	12,0	100,0	7,00
BT022877	13,0	100,0	8,00

**BT022880...BT022886**

 1/2"  
12,5 mm

	mm	L mm	€
BT022880	5,0	140,0	7,00
BT022881	6,0	140,0	7,00
BT022882	7,0	140,0	7,00
BT022883	8,0	140,0	7,00
BT022884	10,0	140,0	7,00
BT022885	12,0	140,0	7,00
BT022886	14,0	140,0	8,00

**BT022890...BT022895**

 1/2"  
12,5 mm

	mm	L mm	€
BT022890	5,0	200,0	8,00
BT022891	6,0	200,0	8,00
BT022892	7,0	200,0	8,00
BT022893	8,0	200,0	8,00
BT022894	10,0	200,0	8,00
BT022895	12,0	200,0	9,00

**BT022030**

30

 1/2"  
12,5 mm

	30	1/2" 12,5 mm	€
BT022030			77,00
9 x		55 mm: 5 - 6 - 7 - 8 - 10 - 12 - 14 - 17 19 mm	
8 x		100 mm: 5 - 6 - 7 - 8 - 10 - 11 - 12 13 mm	
7 x		140 mm: 5 - 6 - 7 - 8 - 10 - 12 14 mm	
6 x		200 mm: 5 - 6 - 7 - 8 - 10 - 12 mm	

**BT022930...BT022937**

 1/2"  
12,5 mm

		L mm	€
BT022930	M5	55,0	6,00
BT022931	M6	55,0	6,00
BT022932	M8	55,0	6,00
BT022933	M9	55,0	6,00
BT022934	M10	55,0	6,00
BT022935	M12	55,0	6,00
BT022936	M14	55,0	7,00
BT022937	M16	55,0	8,00

**BT022940...BT022946**



1/2"  
12,5 mm



		L mm	€
BT022940	M5	100,0	6,00
BT022941	M6	100,0	6,00
BT022942	M8	100,0	6,00
BT022943	M9	100,0	6,00
BT022944	M10	100,0	6,00
BT022945	M12	100,0	7,00
BT022946	M14	100,0	8,00

**BT022950...BT022956**



1/2"  
12,5 mm



		L mm	€
BT022950	M5	140,0	7,00
BT022951	M6	140,0	7,00
BT022952	M8	140,0	7,00
BT022953	M9	140,0	7,00
BT022954	M10	140,0	7,00
BT022955	M12	140,0	7,00
BT022956	M14	140,0	8,00

**BT022960...BT022963**



1/2"  
12,5 mm



		L mm	€
BT022960	M8	200,0	8,00
BT022961	M10	200,0	8,00
BT022962	M12	200,0	9,00
BT022963	M14	200,0	10,50

**BT022026**



26  
1/2"  
12,5 mm



			€
BT022026	26	1/2" 12,5 mm	77,00

8 x		55 mm: M5 - M6 - M8 - M9 - M10 M12 - M14 - M16
7 x		100 mm: M5 - M6 - M8 - M9 - M10 M12 - M14
7 x		140 mm: M5 - M6 - M8 - M9 - M10 M12 - M14
4 x		200 mm: M8 - M10 - M12 - M14

**BT022970...BT022979**

1/2"  
12,5 mm



		L mm	€
BT022970	T20	55,0	6,00
BT022971	T25	55,0	6,00
BT022972	T27	55,0	6,00
BT022973	T30	55,0	6,00
BT022974	T40	55,0	6,00
BT022975	T45	55,0	6,00
BT022976	T50	55,0	6,00
BT022977	T55	55,0	6,00
BT022978	T60	55,0	6,00
BT022979	T70	55,0	7,00

**BT022980...BT022989**

1/2"  
12,5 mm



		L mm	€
BT022980	T20	100,0	6,00
BT022981	T25	100,0	6,00
BT022982	T27	100,0	6,00
BT022983	T30	100,0	6,00
BT022984	T40	100,0	6,00
BT022985	T45	100,0	6,00
BT022986	T50	100,0	6,00
BT022987	T55	100,0	6,00
BT022988	T60	100,0	7,00
BT022989	T70	100,0	8,00

**BT022700...BT022705**

1/2"  
12,5 mm



		L mm	€
BT022700	T40	140,0	7,00
BT022701	T45	140,0	7,00
BT022702	T50	140,0	7,00
BT022703	T55	140,0	7,00
BT022704	T60	140,0	7,00
BT022705	T70	140,0	9,00

**BT022710...BT022715**

1/2"  
12,5 mm



		L mm	€
BT022710	T40	200,0	8,00
BT022711	T45	200,0	8,00
BT022712	T50	200,0	8,00
BT022713	T55	200,0	8,00
BT022714	T60	200,0	9,00
BT022715	T70	200,0	10,50



### BT022902

1/2"  
12,5 mm



		L mm	€
BT022902	TB55	55,0	6,00

### BT022532



32

1/2"  
12,5 mm



			€
BT022532	32	1/2" 12,5 mm	77,00
10 x		55 mm: T20 - T25 - T27 - T30 - T40 T45 - T50 - T55 - T60 - T70	
10 x		100 mm: T20 - T25 - T27 - T30 - T40 T45 - T50 - T55 - T60 - T70	
6 x		140 mm: T40 - T45 - T50 - T55 T60 - T70	
6 x		200 mm: T40 - T45 - T50 - T55 T60 - T70	



### BT022720...BT022728

1/2"  
12,5 mm



		L mm	€
BT022720	M5	55,0	6,00
BT022721	M6	55,0	6,00
BT022722	M7	55,0	6,00
BT022723	M8	55,0	6,00
BT022724	M9	55,0	6,00
BT022725	M10	55,0	6,00
BT022726	M12	55,0	6,00
BT022727	M13	55,0	7,00
BT022728	M14	55,0	7,00

### BT022730...BT022738

1/2"  
12,5 mm



		L mm	€
BT022730	M5	100,0	6,00
BT022731	M6	100,0	6,00
BT022732	M7	100,0	6,00
BT022733	M8	100,0	6,00
BT022734	M9	100,0	6,00
BT022735	M10	100,0	6,00
BT022736	M12	100,0	7,00
BT022737	M13	100,0	8,00
BT022738	M14	100,0	8,00

### BT022740...BT022746

1/2"  
12,5 mm



		L mm	€
BT022740	M8	140,0	7,00
BT022741	M9	140,0	7,00
BT022742	M10	140,0	7,00
BT022743	M10,3	140,0	7,00
BT022744	M12	140,0	7,00
BT022745	M13	140,0	8,00
BT022746	M14	140,0	8,00

### BT022750...BT022756

1/2"  
12,5 mm



		L mm	€
BT022750	M8	200,0	7,00
BT022751	M9	200,0	8,00
BT022752	M10	200,0	8,00
BT022753	M10,3	200,0	9,00
BT022754	M12	200,0	9,00
BT022755	M13	200,0	12,00
BT022756	M14	200,0	12,00

### BT022032



32

1/2"  
12,5 mm



			€
BT022032	32	1/2" 12,5 mm	77,00
9 x		55 mm: M5 - M6 - M7 - M8 - M9 M10 M12 - M13 - M14	
9 x		100 mm: M5 - M6 - M7 - M8 - M9 M10 M12 - M13 - M14	
7 x		140 mm: M8 - M9 - M10 - M10,3 M12 M13 - M14	
7 x		200 mm: M8 - M9 - M10 - M10,3 M12 M13 - M14	

**BT022904**



1/2"  
12,5 mm



	■	L mm	€
BT022904	1/2" 12,5 mm	75,0	7,00

**BT022903**

1/2"  
12,5 mm



	■	L mm	€
BT022903	1/2" 12,5 mm	43,7	6,00

**BT022905**

1/2"  
12,5 mm



	■	□	L mm	€
BT022905	3/8" 10 mm	1/2" 12,5 mm	36,0	5,00

**BT022906**

1/2"  
12,5 mm



	■	□	L mm	€
BT022906	3/4" 19 mm	1/2" 12,5 mm	46,0	6,00

**BT022907**



1/2"  
12,5 mm



	■	○	L mm	€
BT022907	1/2" 12,5 mm	5/16"	37,0	5,00

**BT024006**

- 1/4" x 3/8" ✓
- 1/2" x 3/8" ✓
- 3/8" x 1/4" ✓
- 1/2" x 3/4" ✓
- 3/8" x 1/2" ✓
- 3/4" x 1/2" ✓

- 6
- 1/4"  
6,3 mm
- 3/8"  
10,0 mm
- 1/2"  
12,5 mm



	■	€
BT024006	6 1/4" 6,3 mm + 3/8" 10 mm + 1/2" 12,5 mm	15,00

1 x		1/4" x 3/8"
1 x		3/8" x 1/4"
1 x		1/2" x 3/8"
1 x		1/2" x 3/4"
1 x		3/4" x 1/2"



**BT022901**



1/2"  
12,5 mm



	■	L mm	€
BT022901	1/2" 12,5 mm	250,0	9,00

**BT022908...BT022910**



1/2"  
12,5 mm



	■	L mm	€
BT022908	1/2" 12,5 mm	125,0	6,00
BT022909	1/2" 12,5 mm	250,0	9,00
BT022910	1/2" 12,5 mm	750,0	19,00

**BT022911...BT022913**



1/2"  
12,5 mm



	■	L mm	€
BT022911	1/2" 12,5 mm	50,0	5,00
BT022912	1/2" 12,5 mm	75,0	6,00
BT022913	1/2" 12,5 mm	250,0	9,00

**BT020009**

9  
1/4"  
6,3 mm  
3/8"  
10,0 mm  
1/2"  
12,5 mm

		■	€
BT020009	9	1/4" 6,3 mm + 3/8" 10 mm + 1/2" 12,5 mm	32,00

3 x		50 - 100 - 250 mm
3 x		75 - 150 - 250 mm
3 x		50 - 125 - 250 mm

**BT023002**

2  
1/4"  
6,3 mm  
1/2"  
12,5 mm

		■	€
BT023002	2	1/4" 6,3 mm + 1/2" 12,5 mm	30,00

1 x		150 mm
1 x		250 mm

**BT022900**

1/2"  
12,5 mm

		■	L mm	€
BT022900	1/2" 12,5 mm		250,0	25,00

**BT022995**

1/2"  
12,5 mm

		■	L mm	€
BT022995	1/2" 12,5 mm		250,0	21,00

**BT022992**

1/2"  
12,5 mm

		■	L mm	€
BT022992	1/2" 12,5 mm		305 - 445	25,00

**BT022993**



1/2"  
12,5 mm

		■	L mm	€
BT022993	1/2" 12,5 mm		320 - 445	31,00

**BT022401**

1/2"  
12,5 mm

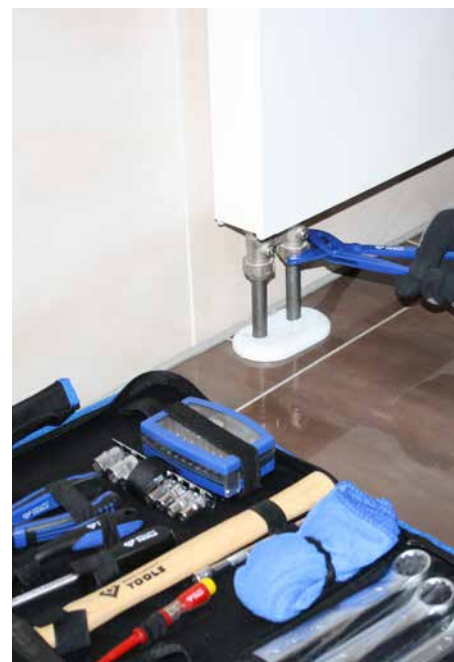
		■	L mm	Erstschepf	€
BT022401	1/2" 12,5 mm		450 - 605	BT022401-1	39,00



**BT025020**



**20**  
3/4"  
19,0 mm



			€
<b>BT025020</b>	20	3/4" 19 mm	123,00

16 x		19 - 22 - 24 - 26 - 27 - 28 - 30 - 32 34 - 36 - 38 - 41 - 42 - 45 - 48 - 50 mm
1 x		3/4" 456 mm
1 x		3/4" 495 mm
2 x		3/4" 100 - 200 mm



**BT025906...BT025907**



3/4"  
19,0 mm



	mm	L mm	€
BT025919	19,0	50,0	9,00
BT025922	22,0	50,0	9,00
BT025924	24,0	50,0	9,00
BT025926	26,0	50,0	9,00
BT025927	27,0	50,0	9,00
BT025928	28,0	52,0	10,50
BT025930	30,0	52,0	10,50
BT025932	32,0	54,0	10,50
BT025934	34,0	55,0	11,00
BT025936	36,0	55,0	11,00
BT025938	38,0	56,0	11,00
BT025941	41,0	58,0	12,00
BT025942	42,0	58,0	12,00
BT025945	45,0	60,0	13,00
BT025948	48,0	65,0	16,00
BT025950	50,0	64,0	16,00



**BT025919...BT025950**



3/4"  
19,0 mm

	mm	L mm	€
<b>BT025906</b>	3/4" 19 mm	100,0	13,00
<b>BT025907</b>	3/4" 19 mm	200,0	16,00

**BT025905**



3/4"  
19,0 mm

	mm	L mm	€
<b>BT025905</b>	3/4" 19 mm	456,0	22,00

**BT025900**



3/4"  
19,0 mm



	mm	L mm	€
<b>BT025900</b>	3/4" 19 mm	495,0	39,00





### BT022645



11  
1/2"  
12,5 mm



		€
BT022645	11 10 - 27 mm	47,00
9 x	10 - 13 - 14 - 17 - 19 - 21 - 22 - 24 - 27 mm	
1 x	125 mm	
1 x	1/2" x 1/2"	

### BT022631...BT022668



1/2"  
12,5 mm

	mm	L mm	€
BT022631	10,0	38,0	7,00
BT022632	11,0	38,0	7,00
BT022633	12,0	38,0	7,00
BT022634	13,0	38,0	7,00
BT022636	14,0	38,0	7,00
BT022637	15,0	38,0	7,00
BT022638	16,0	38,0	7,00
BT022639	17,0	38,0	7,00
BT022641	18,0	38,0	7,00
BT022642	19,0	38,0	7,00
BT022643	20,0	38,0	8,00
BT022644	21,0	38,0	8,00
BT022646	22,0	38,0	8,00
BT022647	23,0	38,0	9,00
BT022648	24,0	38,0	9,00
BT022668	27,0	38,0	9,00

### BT022620



13  
1/2"  
12,5 mm



		€
BT022620	13 1/2" 12,5 mm 10 - 24 mm	47,00
13 x	10 - 11 - 12 - 13 - 14 - 15 - 16 - 17 - 18 - 19 - 21 - 22 - 24 mm	

### BT022649...BT022667



1/2"  
12,5 mm

	mm	L mm	€
BT022649	10,0	78,0	9,00
BT022651	11,0	78,0	9,00
BT022652	12,0	78,0	9,00
BT022653	13,0	78,0	9,00
BT022654	14,0	78,0	9,00
BT022656	15,0	78,0	9,00
BT022657	16,0	78,0	9,00
BT022658	17,0	78,0	9,00
BT022659	18,0	78,0	9,00
BT022661	19,0	78,0	9,00
BT022662	20,0	78,0	10,50
BT022663	21,0	78,0	10,50
BT022664	22,0	78,0	11,00
BT022666	23,0	78,0	11,00
BT022667	24,0	78,0	11,00

### BT022625



13  
1/2"  
12,5 mm



		€
BT022625	13 1/2" 12,5 mm 10 - 24 mm	72,00
13 x	10 - 11 - 12 - 13 - 14 - 15 - 16 - 17 - 18 - 19 - 21 - 22 - 24 mm	

### BT691004...BT691009



1/2"  
12,5 mm

	mm	L mm	€
BT691004	15,0	83,0	7,00
BT691006	17,0	83,0	7,00
BT691007	19,0	83,0	7,00
BT691008	21,0	83,0	8,00
BT691009	22,0	83,0	9,00

### BT691005



3  
1/2"  
12,5 mm



		€
BT691005	3 17 - 21 mm	15,00
3 x	17 - 19 - 21 mm	

### BT691010



5  
1/2"  
12,5 mm



		€
BT691010	5 15 - 22 mm	28,00
5 x	15 - 17 - 19 - 21 - 22 mm	



**BT691011**



<b>BT691011</b>	2	17 - 22 mm	22,00
-----------------	---	------------	-------

1 x		17 - 19 - 21 - 22 mm
1 x		

**BT022682...BT022683**



	mm	L mm	€
<b>BT022682</b>	32,0	50,0	12,00
<b>BT022683</b>	36,0	50,0	13,00

**BT026001...BT026018**



	mm	L mm	€
<b>BT026001</b>	10	50,0	11,00
<b>BT026002</b>	11	50,0	11,00
<b>BT026003</b>	12	50,0	11,00
<b>BT026004</b>	13	50,0	11,00
<b>BT026006</b>	14	50,0	11,00
<b>BT026007</b>	15	50,0	11,00
<b>BT026008</b>	16	50,0	12,00
<b>BT026009</b>	17	50,0	12,00
<b>BT026011</b>	19	50,0	13,00
<b>BT026012</b>	21	50,0	13,00
<b>BT026013</b>	22	50,0	15,00
<b>BT026014</b>	24	50,0	15,00
<b>BT026016</b>	27	50,0	16,00
<b>BT026017</b>	30	50,0	16,00
<b>BT026018</b>	32	50,0	17,00

**BT026000**



<b>BT026000</b>	10	1/2" 12,5 mm	83,00
-----------------	----	--------------	-------

**BT026005**



<b>BT026005</b>	7	1/2" 12,5 mm	88,00
-----------------	---	--------------	-------

**BT022601...BT022609**



		L mm	€
<b>BT022601</b>	T30	78,0	9,00
<b>BT022602</b>	T40	78,0	9,00
<b>BT022603</b>	T45	78,0	9,00
<b>BT022604</b>	T50	78,0	9,00
<b>BT022606</b>	T55	78,0	9,00
<b>BT022607</b>	T60	78,0	9,00
<b>BT022608</b>	T70	78,0	9,00
<b>BT022609</b>	T80	78,0	9,00

**BT022600**



<b>BT022600</b>	8	1/2" 12,5 mm	T30 - T80	47,00
-----------------	---	--------------	-----------	-------

**BT022611...BT022619**



		L mm	€
<b>BT022611</b>	M5	78,0	9,00
<b>BT022612</b>	M6	78,0	9,00
<b>BT022613</b>	M8	78,0	9,00
<b>BT022614</b>	M10	78,0	9,00
<b>BT022616</b>	M12	78,0	9,00
<b>BT022617</b>	M14	78,0	9,00
<b>BT022618</b>	M16	78,0	9,00
<b>BT022619</b>	M18	78,0	9,00

**BT022605**



<b>BT022605</b>	8	1/2" 12,5 mm	M5 - M18	47,00
-----------------	---	--------------	----------	-------



### BT022621...BT022629



1/2"  
12,5 mm

	mm	L mm	€
BT022621	5,0	78,0	9,00
BT022622	6,0	78,0	9,00
BT022623	8,0	78,0	9,00
BT022624	10,0	78,0	9,00
BT022626	12,0	78,0	9,00
BT022627	14,0	78,0	9,00
BT022628	17,0	78,0	9,00
BT022629	19,0	78,0	9,00

### BT022615



8  
1/2"  
12,5 mm

	mm	L mm	€	
BT022615	8	1/2" 12,5 mm	5 - 19 mm	47,00

8 x	5 - 6 - 8 - 10 - 12 - 14 - 17 - 19 mm
-----	---------------------------------------

### BT024601



1/4"  
6,3 mm

	mm	Winkel	€
BT024601	1/4" 6,3 mm	25 ° (Winkel)	10,50

### BT024602



3/8"  
10,0 mm

	mm	Winkel	€
BT024602	3/8" 10 mm	25 ° (Winkel)	13,00

### BT024604



1/2"  
12,5 mm

	mm	Winkel	€
BT024604	1/2" 12,5 mm	25 ° (Winkel)	18,00

### BT024603



3  
3/8"  
10,0 mm  
1/4"  
6,3 mm  
1/2"  
12,5 mm

	mm	Winkel	€
BT024603	3	1/4" - 3/8" - 1/2"	39,00

1 x	1/4" x 1/4"
1 x	3/8" x 3/8"
1 x	1/2" x 1/2"

### BT024605



6  
1/4"  
6,3 mm  
3/8"  
10,0 mm  
1/2"  
12,5 mm  
3/4"  
19,0 mm

	mm	Winkel	€
BT024605	6	1/4" - 3/8" - 1/2" - 3/4"	19,00

1 x	1/4" x 3/8"	1 x	3/8" x 3/8"
1 x	3/8" x 1/4"	1 x	1/2" x 3/4"
1 x	3/8" x 1/2"	1 x	3/4" x 1/2"

### BT022669



1/2"  
12,5 mm

	mm	L mm	€
BT022669	1/2" 12,5 mm	125,0	11,00

### BT025606...BT025614



3/4"  
19,0 mm

	mm	L mm	€
BT025606	24,0	90,0	17,00
BT025607	27,0	90,0	17,00
BT025608	29,0	90,0	17,00
BT025609	30,0	90,0	18,00
BT025611	32,0	90,0	18,00
BT025612	33,0	90,0	18,00
BT025613	34,0	90,0	18,00
BT025614	36,0	90,0	18,00

### BT025600



8  
3/4"  
19,0 mm

	mm	L mm	€	
BT025600	8	3/4" 19 mm	24 - 36 mm	132,00

8 x	24 - 27 - 29 - 30 - 32 - 33 - 34 - 36 mm
-----	--

### BT025601...BT025604



3/4"  
19,0 mm

	mm	L mm	€
BT025601	24,0	45,0	18,00
BT025602	30,0	50,0	20,00
BT025603	32,0	50,0	20,00
BT025604	36,0	50,0	22,00

**BT031000**



6

		€
BT031000	6 PH1 - PH2, 3,0 - 6,5 mm	11,00
4 x	3 x 80 - 4 x 100 - 5,5 x 125 - 6,5 x 150 mm	
2 x	PH1 x 80 mm - PH2 x 100 mm	

**BT031010**



6

		€
BT031010	6 T10 - T30	13,00
6 x	T10 x 80 - T15 x 80 - T20 x 100 T25 x 100 - T27 x 115 - T30 x 115 mm	



**BT031020**



5

		€
BT031020	5 PH1 - PH2, 4,5 - 8,0 mm	17,00
3 x	4,5 x 100 - 5,5 x 125 - 8 x 150 mm	
2 x	PH1 x 80 mm - PH2 x 100 mm	

**BT031031**



	mm	€
BT031031	5,5	4,00



**BT031032**



	mm	€
BT031032	PH 2	4,00

**BT031001...BT031054**

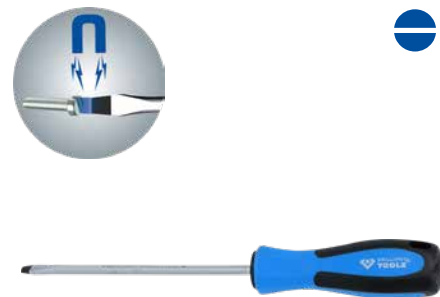

	mm	€
BT031052	2,0	4,00
BT031001	3,0	4,00
BT031002	4,0	4,00
BT031003	4,5	4,00
BT031004	5,5	4,00
BT031005	6,5	5,00
BT031053	8,0	5,00
BT031054	10,0	6,00

**BT031006...BT031036**



	mm	€
BT031035	PH 0	4,00
BT031006	PH 1	4,00
BT031007	PH 2	4,00
BT031036	PH 3	5,00

**BT031011...BT031045**



	mm	€
BT031037	T6	4,00
BT031038	T7	4,00
BT031039	T8	4,00
BT031041	T9	4,00
BT031011	T10	4,00
BT031043	T10	5,00
BT031012	T15	5,00
BT031044	T15	5,00
BT031013	T20	5,00
BT031014	T25	5,00
BT031015	T27	5,00
BT031016	T30	5,00
BT031042	T40	5,00
BT031045	T40	6,00



### BT031021...BT031051



			€
BT031049	5,0	75,0	5,00
BT031021	5,5	125,0	4,00
BT031051	6,0	100,0	5,00
BT031022	8,0	150,0	4,00

### BT031023...BT031047



			€
BT031023	PH 1	80,0	4,00
BT031024	PH 2	100,0	4,00
BT031047	PH 3	150,0	7,00

### BT031055



			€
BT031055	1/4"	100,0	5,00

### BT031056

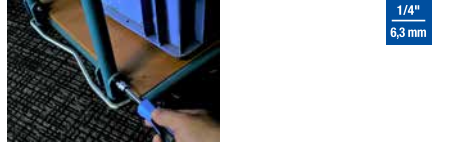

			€
BT031056	1/4" 6,3 mm	60,0	4,00

### BT511005

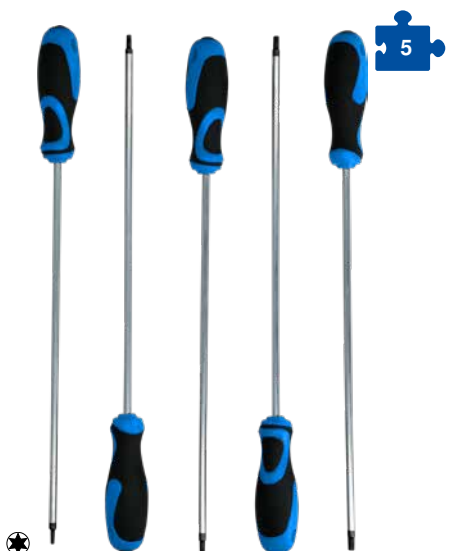

			€
BT511005	5	T15 - T30	32,00

5 x T15 x 405 - T20 x 405 - T25 x 405  
T27 x 405 - T30 x 405 mm

### BT034012



			€
BT034012	12	PH0 - PH4, 3,2 - 9,5 mm	28,00

5 x		5 x 75 - 6 x 38 - 6 x 100 - 8 x 150 9,5 x 200 mm
1 x		3 x 75 mm
5 x		PH1 x 75 - PH2 x 38 - PH2 x 100 PH3 x 150 - PH4 x 200 mm
1 x		PH0 x 75 mm

### BT031070



			€
BT031070	7	5,0 - 12,0 mm	38,00

7 x 5 - 6 - 8 - 9 - 10 - 11 - 12 mm



### BT031071

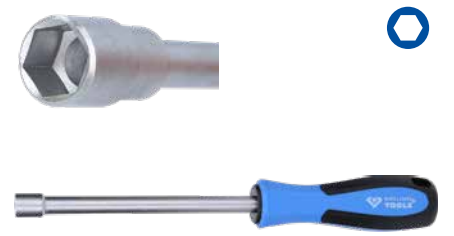

			€
BT031071	5,0	165,0	6,00
BT031072	6,0	165,0	6,00
BT031073	8,0	165,0	7,00
BT031074	9,0	165,0	7,00
BT031076	10,0	165,0	7,00
BT031077	11,0	165,0	7,00
BT031078	12,0	165,0	8,00

### BT031066



			€
BT031066	6,0	335,0	9,00
BT031067	7,0	335,0	9,00
BT031068	8,0	335,0	9,00

**BT045009**



		L mm	€
BT045009	9	max. 180,0	7,00
9 x		1,5 - 2 - 2,5 - 3 - 4 - 5 - 6 - 8 - 10 mm	

**BT045019**



		L mm	€
BT045019	9	max. 225,0	9,00
9 x		1,5 - 2 - 2,5 - 3 - 4 - 5 - 6 - 8 - 10 mm	

**BT044009**



		L mm	€
BT044009	9	max. 180,0	7,00
9 x		T10 - T15 - T20 - T25 - T27 - T30 - T40 T45 - T50	

**BT044019**



		L mm	€
BT044019	9	max. 225,0	10,50
9 x		T10 - T15 - T20 - T25 - T27 - T30 - T40 T45 - T50	

**BT041100**



			€
BT041100	9	2 - 10 mm	28,00
9 x		2 x 100 - 2,5 - 100 - 3 x 100 - 4 x 150 - 5 x 150 6 x 150 - 7 x 150 - 8 x 200 - 10 x 200 mm	



**BT041001...BT041009**



	mm		€
BT041001	2,0	100,0	4,00
BT041002	2,5	100,0	4,00
BT041003	3,0	100,0	4,00
BT041004	4,0	150,0	4,00
BT041005	5,0	150,0	5,00
BT041006	6,0	150,0	5,00
BT041007	7,0	150,0	5,00
BT041008	8,0	200,0	6,00
BT041009	10,0	200,0	8,00

**BT041200**



			€
BT041200	9	T10 - T50, TB10 - TB50	28,00
9 x		T10 - T15 - T20 - T25 - T27 - T30 - T40 T45 - T50	

**BT041011...BT041019**



		€
BT041011	T10 75,0	4,00
BT041012	T15 100,0	4,00
BT041013	T25 150,0	4,00
BT041014	T20 100,0	4,00
BT041015	T27 150,0	5,00
BT041016	T30 150,0	5,00
BT041017	T40 150,0	5,00
BT041018	T45 200,0	6,00
BT041019	T50 200,0	8,00





### BT053532



32  
1/4"  
6,3 mm



BT053532	32	1/4" 6,3 mm	€ 18,00
----------	----	-------------	---------

4 x		4 - 5 - 6,5 - 8 mm
4 x		PH1 - 2 x PH2 - PH3
4 x		PZ1 - 2 x PZ2 - PZ3
4 x		3 - 4 - 5 - 6 mm
7 x		T10 - T15 - T20 - T25 - T27 T30 - T40
7 x		TB10 - TB15 - TB20 - TB25 - TB27 TB30 - TB40
1 x		60 mm
1 x		95 mm

### BT053100



100  
1/4"  
6,3 mm  
25 mm



BT053100	100	1/4" 6,3 mm	€ 17,00
----------	-----	-------------	---------

9 x		3 - 4 - 4,5 - 5 - 5,5 - 6 - 6,5 - 7 - 8 mm
8 x		PH0 - PH1 - 5 x PH2 - PH3
8 x		PZ0 - PZ1 - 5 x PZ2 - PZ3
9 x		1,5 - 2 - 2,5 - 3 - 4 - 5 - 5,5 - 6 - 8 mm
10 x		1/16" - 5/64" - 3/32" - 7/64" - 1/8" 9/64" - 5/32" - 3/16" - 7/32" - 1/4"
6 x		2 - 2,5 - 3 - 4 - 5 - 6 mm
6 x		5/64" - 3/32" - 7/64" - 1/8" - 9/64" 5/32"
9 x		T8 - T10 - T15 - T20 - T25 - T27 T30 - T40 - T45
9 x		TB8 - TB10 - TB15 - TB20 - TB25 TB27 - TB30 - TB35 - TB40
3 x		M5 - M6 - M8
4 x		#0 - #1 - #2 - #3
4 x		4 - 6 - 8 - 10 mm
4 x		#1 - #2 - #3 - #4
3 x		6 - 8 - 10 mm
3 x		#1 - #2 - #3
1 x		50 mm
2 x		25 - 50 mm
1 x		1/4" x 1/4"
1 x		1/4"

### BT053108



108  
1/4"  
6,3 mm

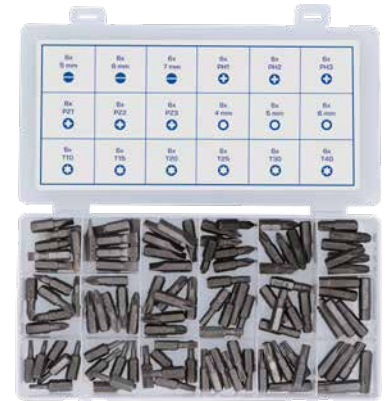

BT053108	108	1/4" 6,3 mm	€ 10,90
----------	-----	-------------	---------

18 x		3 x (5 - 6 - 7 mm)
18 x		3 x (PH1 - PH2 - PH3)
18 x		3 x (PZ1 - PZ2 - PZ3)
18 x		3 x (4 - 5 - 6 mm)
36 x		3 x (T10 - T15 - T20 - T25 - T30 - T40)

### BT053032



32  
1/4"  
6,3 mm



BT053032	32	1/4" 6,3 mm	€ 8,00
----------	----	-------------	--------

4 x		4 - 5 - 6,5 - 8 mm
4 x		PH1 - 2 x PH2 - PH3
4 x		PZ1 - 2 x PZ2 - PZ3
4 x		3 - 4 - 5 - 6 mm
7 x		T10 - T15 - T20 - T25 - T27 T30 - T40
7 x		TB10 - TB15 - TB20 - TB25 - TB27 TB30 - TB40
1 x		1/4" x 1/4"
1 x		60 mm

### BT053208

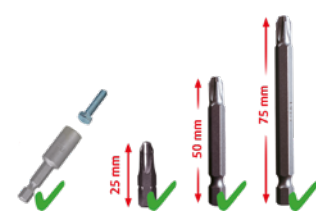

208  
1/4"  
6,3 mm



BT053208	208	1/4" 6,3 mm	€ 41,00
----------	-----	-------------	---------

12 x		2 - 2,5 - 3 - 3,5 - 4 - 4,5 - 5 - 5,5 - 6 6,5 - 7 - 8 mm
18 x		PH00 - PH0 - 5 x PH1 - 5 x PH2 5 x PH3 - PH4
17 x		PZ00 - PZ0 - 5 x PZ1 - 5 x PZ2 4 x PZ3 - PZ4
12 x		1,5 - 2 - 2,5 - 3 - 3,5 - 4 - 4,5 - 5 - 5,5 6 - 7 - 8 mm
10 x		1/16" - 5/64" - 3/32" - 7/64" - 1/8" 9/64" - 5/32" - 3/16" - 7/32" - 1/4"
6 x		2 - 2,5 - 3 - 4 - 5 - 6 mm
6 x		5/64" - 3/32" - 7/64" - 1/8" - 9/64" 5/32"
13 x		T5 - T6 - T7 - T8 - T9 - T10 - T15 T20 - T25 - T27 - T30 - T40 - T45
14 x		TB5 - TB6 - TB7 - TB8 - TB9 - TB10 - TB15 TB20 - TB25 - TB27 - TB30 - TB35 - TB40
3 x		M5 - M6 - M8
4 x		#0 - #1 - #2 - #3
4 x		4 - 6 - 8 - 10 mm
4 x		#1 - #2 - #3 - #4
3 x		6 - 8 - 10 mm
3 x		#1 - #2 - #3
9 x		TS10 - TS15 - TS20 - TS25 - TS27 TS30 - TS40 - TS45 - TS50
3 x		PH1 - PH2 - PH3
3 x		PZ1 - PZ2 - PZ3
5 x		2,5 - 3 - 4 - 5 - 6 mm
7 x		TB10 - TB15 - TB20 - TB25 - TB27 TB30 - TB40
4 x		4 - 6 - 8 - 10 mm
4 x		#1 - #2 - #3 - #4
3 x		6 - 8 - 10 mm
3 x		PH1 - PH2 - PH3
3 x		PZ1 - PZ2 - PZ3
5 x		2,5 - 3 - 4 - 5 - 6 mm
7 x		TB10 - TB15 - TB20 - TB25 - TB27 TB30 - TB40
10 x		4 - 5 - 6 - 7 - 8 - 9 - 10 - 11 - 12 - 13 mm
10 x		5/32" - 3/16" - 7/32" - 1/4" - 9/32" 5/16" - 11/32" - 3/8" - 7/16" - 1/2"
1 x		205 mm
1 x		60 mm
1 x		25 mm

**BT053901**



1/4"  
6,3 mm



	Ø	L mm	€
BT053901	1/4" 6,3 mm	95,0	11,00



**BT053001**



1/4"  
6,3 mm



	Ø	Ø	L mm	€
BT053001	1/4" 6,3 mm	1/4" 6,3 mm	140,0	9,00



**BT053003**



3  
1/4"  
6,3 mm  
3/8"  
10,0 mm  
1/2"  
12,5 mm



	Ø	Ø	Ø	€
BT053003	3	1/4" 6,3 mm + 3/8" 10 mm + 1/2" 12,5 mm		6,00

1 x		1/4" 6,3 mm	65 mm
1 x		3/8" 10 mm	65 mm
1 x		1/2" 12,5 mm	75 mm





### BT060005



5  
2K



		€
BT060005	5 160 - 250 mm	47,00

1 x		160 mm
1 x		180 mm
1 x		200 mm
1 x		200 mm
1 x		250 mm



### BT061901



2K



	L mm	€
BT061901	160,0	9,00

### BT060901



2K



	L mm	€
BT060901	180,0	10,50

### BT062901



2K



	L mm	€
BT062901	200,0	10,50

### BT060902



2K



	L mm	€
BT060902	200,0	10,50

### BT064902



2K



	L mm	L	€
BT064902	250,0	10"	12,00

### BT064906...BT064908



	L mm	L	€
BT064906	175,0	7"	7,00
BT064907	250,0	10"	9,00
BT064908	300,0	12"	10,50

### BT064910



3



		€
BT064910	3 7" - 12"	25,00

1 x		175 mm
1 x		250 mm
1 x		300 mm

**BT064911...BT064913**



	L mm	€
BT064911	175,0	9,00
BT064912	250,0	10,50
BT064913	300,0	13,00

**BT067110...BT067120**



	Ø	L mm	€
BT067112	1/2"	240,0	13,00
BT067110	1"	320,0	17,00
BT067115	1.1/2"	430,0	22,00
BT067120	2"	656,0	37,00

**BT065003**



	€
BT065003 3 140 - 220 mm	22,00
1 x 140 mm	
1 x 140 mm	
1 x 220 mm	

**BT064915**



	L mm	L	€
BT064915	175,0	7"	8,00

**BT064916**



	L mm	max. Ø Rohr mm	€
BT064916	235,0	200	12,00

**BT065901**



	L mm	€
BT065901	140,0	7,00

**BT064914**



	L mm	L	€
BT064914	250,0	10"	9,00

**BT064917**



	L mm	max. Ø Rohr mm	€
BT064917	300,0	110	22,00

**BT065902**



	L mm	€
BT065902	140,0	8,00



### BT065903



	L mm	€
BT065903	250,0	11,00

### BT065004



	€
BT065004 4 125 - 250 mm	28,00

1 x		160 mm
1 x		180 mm
1 x		200 mm
1 x		200 mm



### BT065016



	€
BT065016 16 150 - 280 mm	71,00

2 x		280 mm
2 x		235 mm
1 x		150 mm
1 x		230 mm
5 x		235 mm
3 x		185 mm
2 x		130 mm

### BT067900



	€
BT067900 4 Ø 12 - 25 mm	25,00

2 x		Ø 12 - 25 mm
2 x		Ø 12 - 25 mm

### BT067000



	€
BT067000 4 Ø 19 - 60 mm	29,00

2 x		Ø 19 - 60 mm
2 x		Ø 19 - 60 mm

### BT067005



	mm	L mm	€
BT067005	12 - 25	125,0	7,00

### BT067006



	mm	L mm	€
BT067006	12 - 25	125,0	7,00

### BT067007



	mm	L mm	€
BT067007	12 - 25	125,0	7,00

**BT067008**



	Ø mm	L mm	€
<b>BT067008</b>	12 - 25	125,0	7,00

**BT067001**



	Ø mm	L mm	€
<b>BT067001</b>	19 - 60	175,0	8,00

**BT067002**



	Ø mm	L mm	€
<b>BT067002</b>	19 - 60	175,0	8,00

**BT067003**



	Ø mm	L mm	€
<b>BT067003</b>	19 - 60	175,0	8,00

**BT067004**



	Ø mm	L mm	€
<b>BT067004</b>	19 - 60	175,0	8,00

**BT066901**



	Ø mm	L mm	€
<b>BT066901</b>	2,4 - 4,8	260,0	18,00

**BT066900**



	Ø mm	L mm	€
<b>BT066900</b>	3,2 - 6,4	320,0	28,00



**BT066950**



	Quantity	Ø mm	€
<b>BT066950</b>	400	Ø 2,4 - 3,2 - 4,0 - 4,8 mm	11,00
1 x		Ø 2,4 mm	
1 x		Ø 3,2 mm	
1 x		Ø 4,0 mm	
1 x		Ø 4,8 mm	

**BT066902**



	Ø mm	L mm	€
<b>BT066902</b>	2,5 - 3 - 3,5 - 4 - 4,5 - 5	220,0	9,00

**BT068018...BT068024**



	L mm	L	€
<b>BT068018</b>	450,0	18"	21,00
<b>BT068024</b>	600,0	24"	29,00

**BT068010**

			€
<b>BT068010</b>	9	PH0 - PH3, 3,0 - 6,5 mm	<b>18,00</b>

4 x		3 x 75 mm - 4 x 100 - 5,5 x 125 6,5 x 150 mm
4 x		PH0 x 75 mm - PH1 x 80 mm PH2 x 100 mm - PH3 x 150 mm
1 x		3 x 140 mm

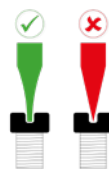
**BT068002...BT068005**

			€
<b>BT068002</b>	3,0	75,0	<b>6,00</b>
<b>BT068003</b>	4,0	100,0	<b>6,00</b>
<b>BT068004</b>	5,5	125,0	<b>7,00</b>
<b>BT068005</b>	6,5	150,0	<b>7,00</b>

**BT068006...BT068009**

		€
<b>BT068006</b>	PH 0	75,0
<b>BT068007</b>	PH 1	80,0
<b>BT068008</b>	PH 2	100,0
<b>BT068009</b>	PH 3	150,0

**BT068011**

	L mm	€
<b>BT068011</b>	185,0	<b>17,00</b>

**BT068012**

	L mm	€
<b>BT068012</b>	208,0	<b>17,00</b>

**BT068013**

	L mm	€
<b>BT068013</b>	160,0	<b>15,00</b>

**BT068014**

	L mm	€
<b>BT068014</b>	160,0	<b>17,00</b>

**BT068015**

	L mm	€
<b>BT068015</b>	170,0	<b>13,00</b>



**BT068001**



		L mm	€
BT068001	3,0	140,0	125 - 250 V 4,00

**BT120900**



		L mm	€
BT120900	3,0	140,0	100 - 500 V 4,00

**BT121900**



	L mm	€
BT121900	100,0	6 - 24 V 5,00



**BT122910**

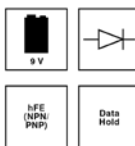

**Technische Daten:**

Batterie enthalten: Nein  
 Gleichspannung: 200 mV - 600 V  
 Wechselspannung: 200 V - 600 V  
 Gleichstrom: 10 A  
 Widerstandsmessung: 200 Ohm - 2 Megaohm

	€
BT122910	200 V - 600 V 11,00

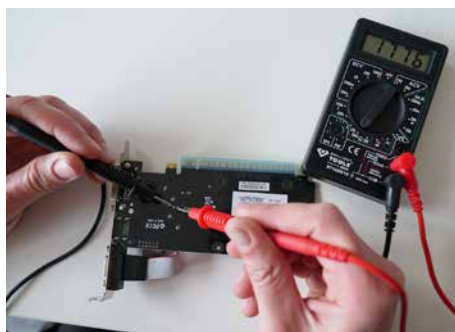

**BT122900**

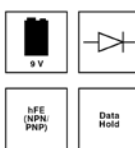

**Technische Daten:**

Batterie enthalten: Ja  
 Gleichspannung: 200 mV - 600 V  
 Wechselspannung: 200 V - 600 V  
 Gleichstrom: 10 A  
 Widerstandsmessung: 200 Ohm - 2 Megaohm

	€
BT122900	200 V - 600 V 16,00

**BT124030**



**Technische Daten:**

Betriebstemperatur: 0 - 430°C  
 Leistung: 30 Watt  
 Betriebsspannung: 230 V AC, 50 HZ  
 Anschlusskabelänge: 1,5 m  
 Aufheizzeit: 1,5 Minuten

	D mm	€
BT124030	3,8	12,00

**BT124060**



**Technische Daten:**

Betriebstemperatur: 0 - 500°C  
 Leistung: 60 Watt  
 Betriebsspannung: 230 V AC, 50 HZ  
 Anschlusskabelänge: 1,5 m  
 Aufheizzeit: 1,5 Minuten

	D mm	€
BT124060	5,8	12,00

**BT124009**



	L mm	€
BT124009	180,0	25,00

1 x		180 mm
1 x		49 mm
1 x		△ 6 mm
1 x		∅ 1,6 mm

**BT067601****2K**

	L mm	€
BT067601	120,0	7,00

**BT067602****2K**

	L mm	€
BT067602	115,0	7,00

**BT067603****2K**

	L mm	€
BT067603	130,0	7,00

**BT067604****2K**

	L mm	€
BT067604	125,0	7,00

**BT067606****2K**

	L mm	€
BT067606	155,0	7,00

**BT067607****2K**

	L mm	€
BT067607	130,0	7,00

**BT067608****2K**

	L mm	€
BT067608	125,0	7,00

**BT067609****2K**

	L mm	€
BT067609	105,0	7,00

**BT542080****12**

		€
BT542080	12 PH0 - PH00, 2,5 - 3,5 mm, T6-T10, 0°-135°	17,00

2 x		2,5 - 3,5 mm
2 x		PH0 - PH00
4 x		T6 - T6 - T8 - T10
4 x		0° - 45° - 90° - 135°

**BT067905****3**

		€
BT067905	3 Ø 0,9 - 1,4 - 2,5 x 160 mm	6,00

1 x		Ø 0,9 - 1,4 - 2,5 x 160 mm
-----	--	----------------------------

**BT115905**



2



		€
BT115905	2	250 - 740 mm, 200 - 620 mm
		13,00

1 x		Ø 52 mm / 250 - 740 mm
-----	--	------------------------

1 x		Ø 6,5 mm / 200 - 820 mm
-----	--	-------------------------

**BT115900**

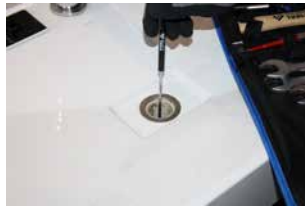

	Ø mm	L mm	Tragkraft kg	€
BT115900	12,5	133 - 645	1,6	6,00

**BT115907**

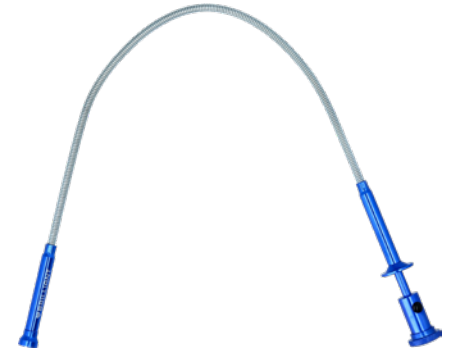

	Ø mm	L mm	Tragkraft kg	€
BT115907	14	620,0	0,3	13,00

**BT115903**



	Ø mm	L mm	Tragkraft kg	€
BT115903	6	150 - 675	0,5	7,00



**BT115906**



	Ø mm	L mm	Tragkraft kg	€
BT115906	6	500,0	0,2	9,00

**BT115908**

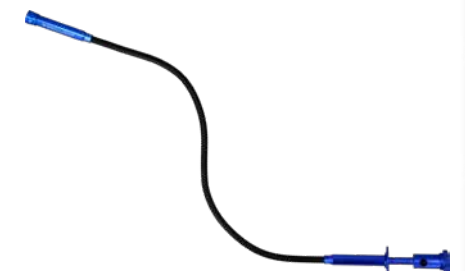

	Ø mm	L mm	Tragkraft kg	€
BT115908	15	620,0	0,3	16,00





### BT631021...BT631023

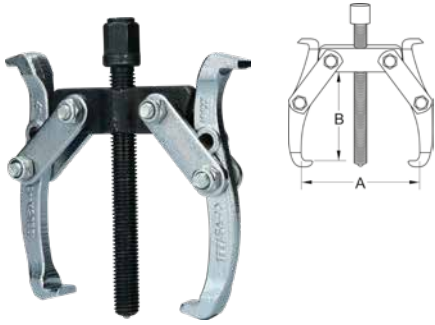

	A mm	B mm	mm	€
BT631021	50 - 90	80	13	18,00
BT631022	60 - 120	130	17	22,00
BT631023	80 - 220	190	19	29,00

### BT631024...BT631026

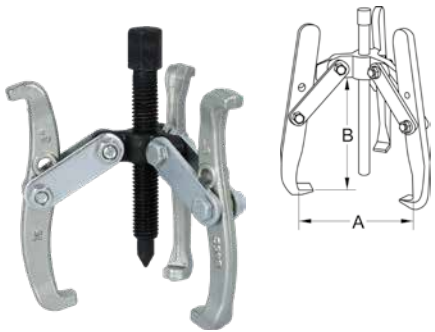

	A mm	B mm	mm	€
BT631024	50 - 90	80	13	28,00
BT631025	60 - 120	120	17	31,00
BT631026	80 - 200	180	19	37,00

### BT631050

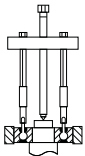

10



	mm	€
BT631050	10	45,00

1 x		160 mm
2 x		130 mm
2 x		105 mm
1 x		110 mm
1 x		
6 x		2 x (Ø 5 - 6 - 8 mm)

### BT631150

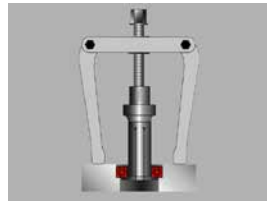

16

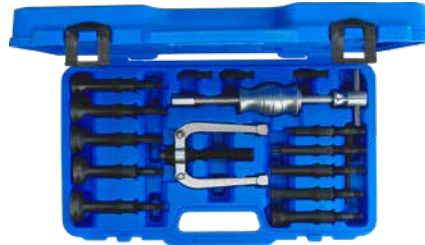

	mm	€
BT631150	16	144,00

10 x		8-11, 12-17, 18-23, 24-29, 30-34, 34-38, 39-43, 44-48, 48-53, 54-58 mm
3 x		M6 x 1,0 - M8 x 1,25 - M10 x 1,5 mm
1 x		
1 x		
1 x		

### BT631100

12



	mm	€
BT631100	12	91,00

1 x		Ø 30 - 56 mm
1 x		Ø 56 - 75 mm

### BT631000

14



	mm	€
BT631000	14	188,00

2 x		165 - 280 mm
3 x		115 mm
3 x		260 mm
3 x		280 mm
1 x		
1 x		

### BT631200

5



	mm	€
BT631200	5	108,00

1 x		
1 x		40 - 80 mm
1 x		50 - 150 mm
1 x		50 - 150 mm
1 x		

**BT073030...BT073150**



	g	€
BT073030	300	10,50
BT073050	500	12,00
BT073080	800	15,00
BT073100	1000	17,00
BT073150	1500	22,00



**BT075100...BT075200**



	g	€
BT075100	1000	15,00
BT075125	1250	17,00
BT075150	1500	19,00
BT075200	2000	25,00

**BT077025...BT077250**



	g	€
BT077025	250	12,00
BT077040	400	13,00
BT077080	800	19,00
BT077100	1000	19,00
BT077150	1600	21,00
BT077250	2500	25,00

**BT071930**



	Ø mm	L mm	€
BT071930	40	320,0	26,00

**BT071931**



	Ø mm	€
BT071931	40	6,00

**BT156912**



	L mm	€
BT156912	300,0	24,00

**BT071925**



	Ø mm	L mm	€
BT071925	32	280,0	20,00

**BT071926**



	Ø mm	€
BT071926	32	4,00





### BT085060



8



		€
BT085060		22,00
8		
5 x	Ø 3 - 4 - 5 - 6 - 8 x 150 mm	
1 x	15 x 150 mm	
1 x	4 x 150 mm	
1 x	3 x 150 mm	

### BT085010



12



		€
BT085010		30,00
12		
3 x	3 x 145 - 5 x 245 - 9 x 245 mm	
6 x	12 x 165 - 15 x 175 - 19 x 195 20 x 195 - 22 x 240 - 25 x 240 mm	
1 x	9,4 x 195 mm	
2 x	4 x 145 - 6 x 195 mm	



### BT085030



28



		€
BT085030		50,00
28		
6 x	2,4 x 110 - 3,2 x 120 - 4 x 125 5 x 135 - 6,5 x 145 - 9,5 x 195 mm	
8 x	2,4 x 135 - 3 x 145 - 3,2 x 145 - 4 x 150 5 x 160 - 5 x 245 - 6,5 x 170 - 9,5 x 245 mm	
9 x	9,5 x 140 - 12 x 165 - 12,5 x 150 15 x 175 - 16 x 165 - 19 x 195 20 x 195 - 22 x 240 - 25 x 240 mm	
4 x	3 x 125 - 4,5 x 145 - 4,8 x 150 6 x 195 mm	
1 x		

### BT085070



6



		€
BT085070		15,00
6		
6 x	Ø 3 - 4 - 5 - 6 - 7 - 8 mm	

### BT085080



6



		€
BT085080		19,00
6		
6 x	Ø 3 - 4 - 5 - 6 - 7 - 8 mm	

**BT080918**



	Schneidbreite mm	L mm	€
<b>BT080918</b>	18,0	150,0	6,00



**BT084911**



	Schlag- gewicht kg	L mm	€
<b>BT084911</b>	30,00	130,0	6,00

**BT090900**



	L mm	€
<b>BT090900</b>	600,0	20,00



**BT081906**



	Spitzenbreite mm	L mm	€
<b>BT081906</b>	6	150,0	6,00

**BT084910**



	Ø mm	L mm	€
<b>BT084910</b>	10	150,0	5,00

**BT091004**



		€
<b>BT091004</b>	4	22,00

4 x		10 x 250 - 15 x 300 - 20 x 445 20 x 600 mm
-----	---	---



**BT102905**

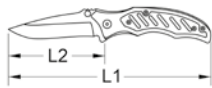

	L1 mm	L2 mm	€
BT102905	210,0	90,0	12,00

**BT102900**



2K

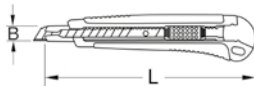

	L mm	B mm	€
BT102900	160,0	18,0	4,00

**BT102901**



10



	10	L mm	B mm	S mm	€
BT102901	10	100,0	18,0	0,5	2,50

**BT100900**



2K

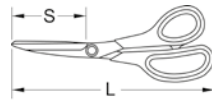

	L mm	S mm	€
BT100900	200,0	90,0	4,00

**BT100901**



2K

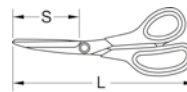

	L mm	S mm	€
BT100901	145,0	50,0	5,00

**BT100902**



Lock

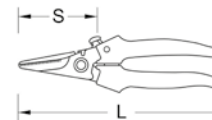

	L mm	S mm	€
BT100902	150,0	32,0	5,00

**BT100903**



	L mm	€
BT100903	150,0	21,00

**BT101922**



10x ✓



	L mm	€
BT101922	110,0	6,00

**BT101923**



10x ✓



	L mm	€
BT101923	145,0	6,00

**BT101924**

2



		€
BT101924	2	2,00



**BT101930**

4



		€
BT101930	4	41,00

2 x		20 x 43 mm
2 x		31 x 94 mm



**BT101950**

32



		€
BT101950	32	51,00

1 x		M3 - M12
1 x		M3 - M12
1 x		6,0 x 110 mm
1 x		0,5 - 1,75 mm
7 x		M3 x 0,5 - M4 x 0,7 - M5 x 0,8 - M6 x 1,0 M8 x 1,25 - M10 x 1,5 - M12 x 1,75 mm
7 x		M3 x 0,5 - M4 x 0,7 - M5 x 0,8 - M6 x 1,0 M8 x 1,25 - M10 x 1,5 - M12 x 1,75 mm

**BT101985**

110



		€
BT101985	110	199,00

2 x		M3 - M12 - M6 - M20
2 x		M2 - M9 - M10 - M18
1 x		M2 - M3
35 x		M2 x 0,4 - M3 x 0,5 - M4 x 0,7 - M5 x 0,8 - M6 x 0,75 M6 x 1,0 - M7 x 0,75 - M7 x 1,0 - M8 x 0,75 - M8 x 1,0 M8 x 1,25 - M9 x 0,75 - M9 x 1,0 - M9 x 1,25 - M10 x 0,75 M10 x 1,0 - M10 x 1,25 - M10 x 1,5 - M11 x 0,75 - M11 x 1,0 M11 x 1,25 - M11 x 1,5 - M12 x 0,75 - M12 x 1,0 - M12 x 1,25 M12 x 1,5 - M12 x 1,75 - M14 x 1,0 - M14 x 1,25 - M14 x 1,5 M14 x 2,0 - M16 x 2,0 - M16 x 1,5 - M16 x 1,0 - M18 x 1,5 mm
35 x		M2 x 0,4 - M3 x 0,5 - M4 x 0,7 - M5 x 0,8 - M6 x 0,75 M6 x 1,0 - M7 x 0,75 - M7 x 1,0 - M8 x 0,75 - M8 x 1,0 M8 x 1,25 - M9 x 0,75 - M9 x 1,0 - M9 x 1,25 - M10 x 0,75 M10 x 1,0 - M10 x 1,25 - M10 x 1,5 - M11 x 0,75 - M11 x 1,0 M11 x 1,25 - M11 x 1,5 - M12 x 0,75 - M12 x 1,0 - M12 x 1,25 M12 x 1,5 - M12 x 1,75 - M14 x 1,0 - M14 x 1,25 - M14 x 1,5 M14 x 2,0 - M16 x 2,0 - M16 x 1,5 - M16 x 1,0 - M18 x 1,5 mm



**BT101925**



		Ø mm	€
BT101925	3	4 - 32	45,00

1 x		Ø 4 - 12 mm
1 x		Ø 4 - 20 mm
1 x		Ø 4 - 32 mm

**BT101926**



	Ø mm	€
BT101926	4 - 12	10,50

**BT101927**



	Ø mm	€
BT101927	4 - 20	17,00

**BT101928**



	Ø mm	€
BT101928	4 - 32	29,00

**BT101941**

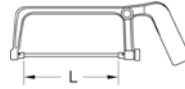

	L mm	€
BT101941	150	7,00

**BT101942**

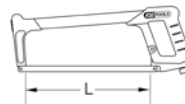

	L mm	€
BT101942	310	12,00

**BT067200**



		€
BT067200	3	32,00

**BT067201**



	L mm	€
BT067201	250,0	12,00

**BT067202**



	L mm	€
BT067202	250,0	12,00

**BT067203**



	L mm	€
BT067203	250,0	12,00



**BT100950**



5



		€
<b>BT100950</b>	5	21,00

1 x		150 mm
1 x		150 mm
1 x		200 mm
2 x		200 - 250 mm

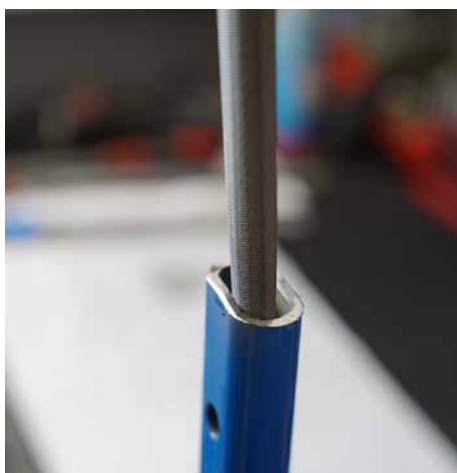

**BT103030**

19



		€
<b>BT103030</b>	19	34,00

1 x		310 mm
1 x		310 mm
1 x		310 mm
1 x		310 mm
2 x		145 mm
2 x		145 mm
2 x		145 mm
2 x		145 mm
2 x		145 mm
2 x		145 mm
2 x		145 mm
1 x		25 x 205 mm



**BT103000**



20  
1/4"  
6,3 mm



		€
<b>BT103000</b>	20	26,00

6 x		Ø 9 - 11 - 13 - 15 - 17 - 19 mm
6 x		Ø 9 - 11 - 13 - 15 - 17 - 19 mm
6 x		Ø 9 - 11 - 13 - 15 - 17 - 19 mm
1 x		150 mm
1 x		145 mm



**BT706002**



	L mm	Material	€
<b>BT706002</b>	290,0	Stahl	4,00



### BT706003



	L mm	Material	€
BT706003	290,0	Edelstahl	5,00

### BT706009

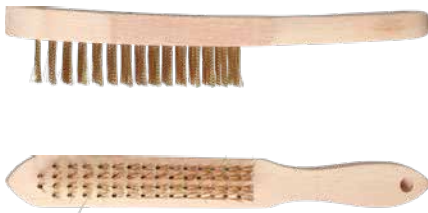

	L mm	Material	€
BT706009	290,0	Messing	6,00

### BT103101



	Ø mm	Aufnahme	UPM max.	€
BT103101	100	M14 x 2,0 mm	12500	8,00

### BT103102



	Ø mm	Aufnahme	UPM max.	€
BT103102	115	Ø 22 mm	12500	8,00

### BT103103



	Ø mm	Aufnahme	UPM max.	€
BT103103	65	M14 x 2,0 mm	12500	8,00

### BT103109



	Ø mm	Aufnahme	UPM max.	€
BT103109	75	6 mm	12500	7,00

### BT103104



	Ø mm	Aufnahme	UPM max.	€
BT103104	25	6 mm	4500	5,00

### BT103105...06



	Ø mm	Aufnahme	UPM max.	€
BT103105	50	6 mm	4500	5,00
BT103106	75	6 mm	4500	6,00

### BT103107...08



	Ø mm	Aufnahme	UPM max.	€
BT103107	75	6 mm	4500	5,00
BT103108	100	6 mm	4500	6,00

### BT103110



	€
BT103110	12,00

1 x		1/4"	Ø 50 mm
1 x		1/4"	Ø 90 mm
1 x		1/4"	Ø 100 mm
1 x		1/4"	Ø 120 mm

**BT110900**



	Länge m	€
<b>BT110900</b>	2,00	9,00



**BT111903**



	Länge m	Bandbreite mm	€
<b>BT111903</b>	3,00	18,0	4,00



**BT114901**



	Messbereich mm	€
<b>BT114901</b>	0,05 - 1	6,00

**BT114903**



	Messbereich mm	€
<b>BT114903</b>	0 - 25	13,00



**BT114902**

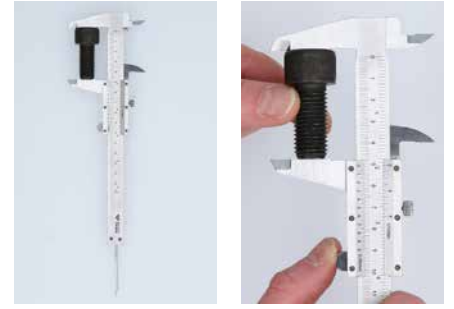

	Messbereich mm	€
<b>BT114902</b>	0 - 150	17,00

**BT114900**



	Messbereich mm	€
<b>BT114900</b>	0-150	21,00





BT141901...BT141905



		N·m	€
BT141905	1/4" 6,3 mm	1-25	82,00
BT141903	3/8" 10 mm	5-50	82,00
BT141904	1/2" 12,5 mm	10-100	82,00
BT141901	1/2" 12,5 mm	20-200	82,00
BT141902	1/2" 12,5 mm	60-320	92,00

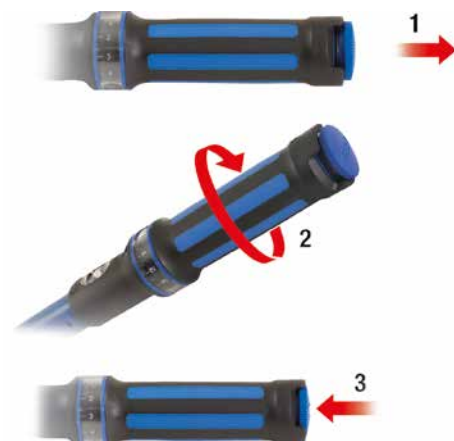

BT141906...BT141910



		N·m	€
BT141906	1/4" 6,3 mm	1-25	92,00
BT141907	3/8" 10 mm	5-50	92,00
BT141908	1/2" 12,5 mm	10-100	92,00
BT141909	1/2" 12,5 mm	20-200	92,00
BT141910	1/2" 12,5 mm	60-320	103,00



**BRILLIANT TOOLS**  
powered by **CSOOS**

Designation / Désignation / Descripción	Drawing / Schéma / Dibujo técnico / Drawn / Dessiné / Dibujado	Manufacturer / Brand / Fabricant	
Article No. / Part number / Referencia		Measurement / Measuring method / Méthode de mesure / Measure de mesure	
Serial No. / Serial number / Número de serie		Serial No. / Serial number / Número de serie	
Manufacturer / Fabricant / Fabricante		Calibration / Calibration / Calibración	
Storage date / Date of issue / Fecha de emisión	As is	Calibration Certificate / Certificate of calibration / Certificado de calibración	
Material / Matériau / Material	St 3.5	Drawn / Drawn / Dessiné	

**KALIBRIER-KONFORMITÄTSERKLÄRUNG**  
DECLARATION OF CONFORMANCE / DECLARATION DE CONFORMITÉ

Die Kalibrierung wurde nach DIN EN ISO 9001:2015 durchgeführt. Die Kalibrierung erfolgt durch ein gegen ein Messnormenlabor, das durch ein akkreditiertes DAkkS-Labor kalibriert und durch ein nationales Referenzlabor validiert ist.

Testing procedures are in accordance with the ISO 9001:2015 rules of the EN ISO 9001. This calibration is performed by competent and reference standards which are referenced to the accuracy DAkkS - laboratory and thus traceable to the national measurement standards.

La production de test est conforme à l'édition 2005 de la norme DIN EN ISO 9001. La calibration est effectuée par un laboratoire dont les étalons de référence se réfèrent au laboratoire agréé DAkkS ou être référencés aux étalons nationaux.

Substanz / Substance / Sustancia	Min.	Max.	Min.	Max.
1. Prüfung / Test				
2. Prüfung / Test				
3. Prüfung / Test				
4. Prüfung / Test				
5. Prüfung / Test				

Measurement / Accuracy / Précision / %

Measurement / Accuracy / Précision / %

Das Drehmomentlabor entspricht den geforderten Toleranzen von ± 0,5 Abweichung. Le laboratoire de mesure respecte une tolérance de ± 0,5.

Elabor / Brand / Constructeur

Produit / Hersteller / Fabricant

certified by the DAkkS and other international labs.

As per certificate of accreditation, produced by reference to National Calibration Certificate (DIN EN ISO 9001:2015).

certified by the DAkkS and other international labs.

In accordance with DIN EN ISO 9001:2015, the calibration was carried out under the following conditions: temperature range of 10° to 20° and a relative humidity of 30 to 70%.

Conformément à la norme DIN EN ISO 9001:2015, la calibration a été effectuée dans une plage de température comprise entre 10° et 20° C et une humidité relative comprise entre 30 et 70%.

CSOOS Messwerkzeuge GmbH | Temperature Level 10 to 20 °C, Relative Humidity 30 to 70% | CSOOS Messwerkzeuge GmbH | Température Niveau 10 à 20 °C, Humidité Relative 30 à 70% | CSOOS Messwerkzeuge GmbH | Temperature Level 10 to 20 °C, Relative Humidity 30 to 70% | CSOOS Messwerkzeuge GmbH | Température Niveau 10 à 20 °C, Humidité Relative 30 à 70%

BT142005



		N·m	€	
BT142005	5	1/2" 12,5 mm	40-200	50,00
1 x		1/2"	20 - 200 Nm	
1 x		1/2"	125 mm	
3 x		1/2"	17 - 18 - 21 mm	



### BT160400

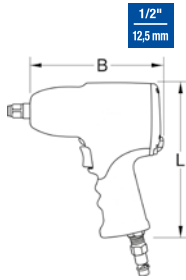

#### Technische Daten:

max. Rechtslauf-Drehmoment:	180 - 470 - 710 Nm
max. Löse-Drehmoment:	1240 Nm
Leerlaufdrehzahl:	9000 U/min
Vibrationsbeschleunigung:	10,25 m/s <sup>2</sup>
Schallleistungspegel:	108,9 dB(A)
Schalldruckpegel:	115 dB(A)
Luftverbrauch:	170 l/min
Betriebsdruck max:	6,3 bar
min. Schlauchdurchmesser:	10 mm
Anschlussgewinde:	1/4"PT

	L mm	B mm	kg	€
BT160400	180,0	135,0	1,26	67,00

### BT160200

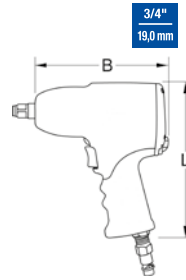

#### Technische Daten:

max. Rechtslauf-Drehmoment:	610 - 950 - 1230 Nm
max. Löse-Drehmoment:	1800 Nm
Leerlaufdrehzahl:	8500 U/min
Vibrationsbeschleunigung:	17,25 m/s <sup>2</sup>
Schallleistungspegel:	100,9 dB(A)
Schalldruckpegel:	91 dB(A)
Luftverbrauch:	198 l/min
Betriebsdruck max:	6,3 bar
min. Schlauchdurchmesser:	10 mm
Anschlussgewinde:	1/4"PT

	L mm	B mm	kg	€
BT160200	185,0	190,0	2,20	113,00

### BT160601



1/4"  
6,3 mm



#### Technische Daten:

max. Löse-Drehmoment:	35 Nm
Leerlaufdrehzahl:	240 U/min
Vibrationsbeschleunigung:	3,47 m/s <sup>2</sup>
Schallleistungspegel:	98,5 dB(A)
Schalldruckpegel:	87,5 dB(A)
Luftverbrauch:	77 l/min
Betriebsdruck max:	6,3 bar
min. Schlauchdurchmesser:	10 mm
Anschlussgewinde:	1/4"PT

	L mm	kg	€
BT160601	200,0	0,50	52,00

### BT160602



3/8"  
10,0 mm



#### Technische Daten:

max. Löse-Drehmoment:	35 Nm
Leerlaufdrehzahl:	240 U/min
Vibrationsbeschleunigung:	3,5 m/s <sup>2</sup>
Schallleistungspegel:	98,5 dB(A)
Schalldruckpegel:	87,5 dB(A)
Luftverbrauch:	77 l/min
Betriebsdruck max:	6,3 bar
min. Schlauchdurchmesser:	10 mm
Anschlussgewinde:	1/4"PT

	L mm	kg	€
BT160602	200,0	0,60	55,00

### BT160600



1/2"  
12,5 mm



#### Technische Daten:

max. Löse-Drehmoment:	67 Nm
Leerlaufdrehzahl:	160 U/min
Vibrationsbeschleunigung:	3,3 m/s <sup>2</sup>
Schallleistungspegel:	100,5 dB(A)
Schalldruckpegel:	89,5 dB(A)
Luftverbrauch:	144 l/min
Betriebsdruck max:	6,3 bar
min. Schlauchdurchmesser:	10 mm
Anschlussgewinde:	1/4"PT

	L mm	kg	€
BT160600	310,0	1,20	82,00

### BT160100

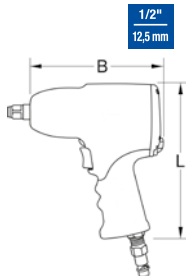

#### Technische Daten:

max. Rechtslauf-Drehmoment:	490 - 660 - 870 Nm
max. Löse-Drehmoment:	1450 Nm
Leerlaufdrehzahl:	8500 U/min
Vibrationsbeschleunigung:	17,5 m/s <sup>2</sup>
Schallleistungspegel:	100,9 dB(A)
Schalldruckpegel:	90 dB(A)
Luftverbrauch:	169 l/min
Betriebsdruck max:	6,3 bar
min. Schlauchdurchmesser:	10 mm
Anschlussgewinde:	1/4"PT

	L mm	B mm	kg	€
BT160100	185,0	190,0	2,20	61,00

### BT115902



max. Traglast kg	€
4,5	19,00



### BT160701



#### Technische Daten:

Leerlaufdrehzahl:	20000 U/min
Vibrationsbeschleunigung:	5,0 m/s <sup>2</sup>
Schallleistungspegel:	101,6 dB(A)
Schalldruckpegel:	99,1 dB(A)
Luftverbrauch:	85 l/min
Betriebsdruck max:	6,3 bar
min. Schlauchdurchmesser:	10 mm
Anschlussgewinde:	1/4"PT

	Spannfutter Ø mm	L mm	kg	€
BT160701	3 + 6	180,0	0,45	77,00



### BT160702



#### Technische Daten:

Leerlaufdrehzahl:	22000 U/min
Vibrationsbeschleunigung:	2,9 m/s <sup>2</sup>
Schallleistungspegel:	97,1 dB(A)
Schalldruckpegel:	86,1 dB(A)
Luftverbrauch:	128 l/min
Betriebsdruck max:	6,3 bar
min. Schlauchdurchmesser:	10 mm
Anschlussgewinde:	1/4"PT

	Spannfutter Ø mm	L mm	kg	€
BT160702	3 + 6	215,0	0,52	50,00

### BT160705



#### Technische Daten:

Leerlaufdrehzahl:	22000 U/min
Vibrationsbeschleunigung:	2,1 m/s <sup>2</sup>
Schallleistungspegel:	95,1 dB(A)
Schalldruckpegel:	82,4 dB(A)
Luftverbrauch:	85 l/min
Betriebsdruck max:	6,3 bar
min. Schlauchdurchmesser:	10 mm
Anschlussgewinde:	1/4"PT

	Spannfutter Ø mm	L mm	kg	€
BT160705	3 + 6	180,0	0,32	44,00

### BT160700



#### Technische Daten:

Leerlaufdrehzahl:	22000 U/min
Vibrationsbeschleunigung:	2,1 m/s <sup>2</sup>
Schallleistungspegel:	95,1 dB(A)
Schalldruckpegel:	82,4 dB(A)
Luftverbrauch:	85 l/min
Betriebsdruck max:	6,3 bar
min. Schlauchdurchmesser:	10 mm
Anschlussgewinde:	1/4"PT

	Spannfutter Ø mm	L mm	kg	€
BT160700	15	3 + 6	180,0	55,00

1 x		310 mm
1 x		1/4" PT
1 x		3 mm
2 x		11,5 - 17 mm
1 x		
1 x		3 mm: Ø 12 mm
1 x		3 mm: Ø 12 mm
1 x		3 mm: Ø 12 mm
1 x		3 mm: Ø 13 mm
1 x		3 mm: Ø 12 mm
1 x		6 mm: Ø 22 mm
1 x		6 mm: Ø 13 mm
1 x		6 mm: Ø 24 mm
1 x		6 mm: Ø 24 mm
1 x		6 mm: Ø 19 mm

### BT160711



	€
BT160711	10,50

1 x		3 mm: Ø 12 mm
1 x		3 mm: Ø 12 mm
1 x		3 mm: Ø 12 mm
1 x		3 mm: Ø 13 mm
1 x		3 mm: Ø 12 mm
1 x		6 mm: Ø 22 mm
1 x		6 mm: Ø 13 mm
1 x		6 mm: Ø 24 mm
1 x		6 mm: Ø 24 mm
1 x		6 mm: Ø 19 mm



**BT160703**



**Technische Daten:**

Leerlaufdrehzahl:	18000 U/min
Vibrationsbeschleunigung:	1,67 m/s <sup>2</sup>
Schallleistungspegel:	90,4 dB(A)
Schalldruckpegel:	79,4 dB(A)
Luftverbrauch:	128 l/min
Betriebsdruck max:	6,3 bar
min. Schlauchdurchmesser:	10 mm
Anschlussgewinde:	1/4"PT

	Spannfutter Ø mm	L mm	kg	€
<b>BT160703</b>	6	225,0	0,70	<b>70,00</b>

**BT160704**



**Technische Daten:**

Leerlaufdrehzahl:	1800 U/min
Vibrationsbeschleunigung:	1,5 m/s <sup>2</sup>
Schallleistungspegel:	103 dB(A)
Schalldruckpegel:	92 dB(A)
Luftverbrauch:	114 l/min
Betriebsdruck max:	6,3 bar
min. Schlauchdurchmesser:	10 mm
Anschlussgewinde:	1/4"PT

	Spannfutter Ø mm	L mm	B mm	kg	€
<b>BT160704</b>	1 - 10	170,0	160,0	0,94	<b>74,00</b>

**BT160710**

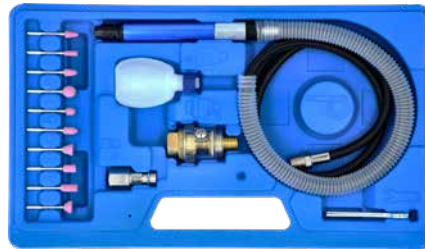

**Technische Daten:**

Leerlaufdrehzahl:	54000 U/min
Vibrationsbeschleunigung:	1,2 m/s <sup>2</sup>
Schallleistungspegel:	79,5 dB(A)
Schalldruckpegel:	68,5 dB(A)
Luftverbrauch:	60,3 l/min
Betriebsdruck max:	6,2 bar
min. Schlauchdurchmesser:	3/8" - 9,52 mm mm
Anschlussgewinde:	1/4"PT

	Spannfutter Ø mm	L mm	€
<b>BT160710</b>	16	132,0	<b>48,00</b>

**BT160500**



	Spannfutter Ø mm	L mm	€
<b>BT160500</b>	3	100 - 330 - 510 mm	<b>13,00</b>

1 x		100 mm
1 x		330 mm
1 x		510 mm

**BT161103**



	Spannfutter Ø mm	L mm	€
<b>BT161103</b>	5	25 - 100 - 200 mm	<b>8,00</b>

1 x		130 g
3 x		25 - 100 - 200 mm
2 x		1/4" - 6 mm



**BT161104**



	Schlauchlänge m	€
<b>BT161104</b>	0,5	<b>19,00</b>



### BT160300



#### Technische Daten:

Luftverbrauch: 210 l/min  
 Betriebsdruck max.: 9,2 bar  
 min. Schlauchdurchmesser: 10 mm  
 Anschlussgewinde: 1/4"PT

	€
BT160300 1.000 ml	47,00

### BT160005...BT160015



	Ø mm	Schlauchlänge m	€
BT160005	6	10	13,00
BT160010	9	5	17,00
BT160015	9	10	26,00

### BT160030



	Ø mm	Schlauchlänge m	€
BT160030	6	10	13,00

### BT160035



	Ø mm	Schlauchlänge m	€
BT160035	10	10	30,00

### BT161101



#### Technische Daten:

max. Druck: 20 bar  
 Schlauchinnendurchmesser: 8 mm  
 Anschlussgewinde: 1/4"

	Ø mm	Schlauchlänge m	€
BT161101	8	10 + 1,5	67,00

### BT161100

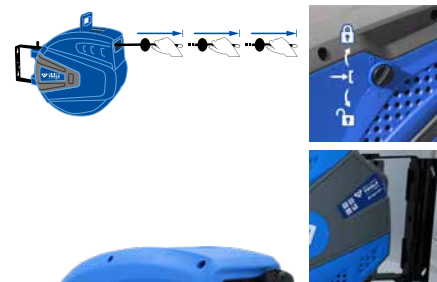

#### Technische Daten:

max. Druck: 18 bar  
 Schlauchinnendurchmesser: 10 mm  
 Anschlussgewinde: 3/8"

	Ø mm	Schlauchlänge m	€
BT161100	10	15 + 1,4	78,00



### BT160706



#### Technische Daten:

Leerlaufdrehzahl: 16000 U/min  
 Vibrationsbeschleunigung: < 0,75 m/s²  
 Schallleistungspegel: 89,3 dB(A)  
 Schalldruckpegel: 78,3 dB(A)  
 Luftverbrauch: 200 l/min  
 Betriebsdruck max.: 6,3 bar  
 min. Schlauchdurchmesser: 3/8" - 10 mm mm  
 Anschlussgewinde: 1/4"PT

	Bandbreite mm	kg	€
BT160706	12,0	0,94	68,00

### BT160707



	Körnung	€
BT160707	60	

### BT160708



	Körnung	€
BT160708	120	

**BT162000**

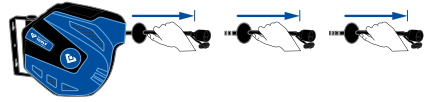

**Technische Daten:**

Arbeitskabellänge: 15 m  
Anschlusskabellänge: 1,0 m  
Querschnitt in mm<sup>2</sup>: 3 x 1,5 mm<sup>2</sup>  
Leitung: H05VV-F 1,5 mm<sup>2</sup>  
Maximale Leistung aufgerolltes Kabel: 1000 W  
Maximale Leistung entrolltes Kabel: 3000 W  
Spritzwasserschutz: IP44

		€
<b>BT162000</b>	15 + 1 m	93,00



**BT094901**



	Inhalt	€
<b>BT094901</b>	310 ml	12,00

**BT094902**



	Inhalt	€
<b>BT094902</b>	500 ml	34,00

**BT156930...BT156933**



	Größe	Inhalt	€
<b>BT156930</b>	7	12 Paar	12,00
<b>BT156931</b>	8	12 Paar	12,00
<b>BT156932</b>	9	12 Paar	12,00
<b>BT156933</b>	10	12 Paar	12,00

**BT156910**



		€
<b>BT156910</b>		4,00

**BT156917**



		€
<b>BT156917</b>	0,3 l	7,00

**BT101935**



		€
<b>BT101935</b>	4 50 - 120 mm	4,00

4 x		50 - 75 - 100 - 120 mm
-----	--	------------------------

**BT101940**



		€
<b>BT101940</b>	4 50 - 120 mm	4,00

4 x		50 - 80 - 100 - 120 mm
-----	--	------------------------



### BT716003...BT716005



		€
BT716003	5 l	7,00
BT716004	8 l	9,00
BT716005	13 l	12,00

### BT716002



		€
BT716002	16 l	17,00

### BT156921



	L mm	B mm	€
BT156921	1050,0	520,0	26,00

### BT156923



	Material	€
BT156923	Nylon	17,00

### BT156942



	Spannbereich mm	Backenlänge mm	Backenlänge	€
BT156942	0 - 190	150,0	6"	139,00

### BT156940



		Backenlänge mm	Material	€
BT156940	2	150,0	TPU	13,00

### BT156941



		Backenlänge mm	Material	€
BT156941	2	150,0	TPU	13,00

### BT180005



	max. Traglast kg	€
BT180005	500	81,00

### BT180010



	max. Traglast t	max. Gesamtbauhöhe mm	max. Gesamtbauhöhe mm	€
BT180010	2	280,0	435,0	47,00

### BT156919



	L mm	B mm	Stärke mm	€
BT156919	480,0	320,0	30,0	9,00

BT156920



	L mm	B mm	Stärke mm	€
BT156920	1200,0	400,0	23,0	21,00



BT156905



	L mm	B mm	H mm	max. Traglast kg	€
BT156905	1030,0	480,0	115,0	120	45,00



BT180000



	L mm	B mm	max. Traglast kg	min. Höhe mm	max. Höhe mm	€
BT180000	1170,0	520,0	150	117,0	780,0	155,00



BT150800

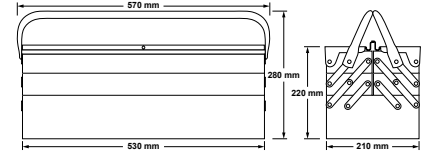

	L mm	B mm	H mm	€
BT150800	530,0	210,0	220,0	41,00



BT156916



	3	Ø mm	1,2	€
BT156916	3	160,0	1,2	9,00

1 x		Ø 160 mm / 1,2 L
1 x		
1 x		400 mm



**BT130910**



	L mm	Ø mm	€	
BT130910	40 Lumen / 140 Lumen	168,0	25	6,00

**BT150900**



	max. Traglast kg	Länge mm	Breite mm	Höhe mm	€
BT150900	40	680,0	425,0	850,0	154,00



**BT152900**

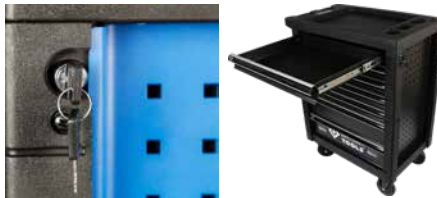

	max. Traglast kg	Länge mm	Breite mm	Höhe mm	Anzahl	€
BT152900	400	770,0	470,0	975,0	7	404,00

**BT153207**



	€
BT153207	466,00

1 x		770 x 470 x 975 mm	
1 x			+24
1 x			+170
1 x			+12





**BT153473**



**473**

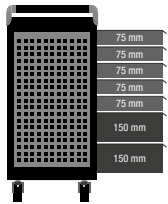

75 mm  
75 mm  
75 mm  
75 mm  
150 mm  
150 mm

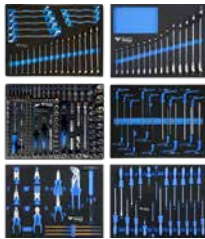

		€
<b>BT153473</b>	473	674,00

1 x		770 x 470 x 975 mm
1 x		+24
1 x		+16
1 x		+170
1 x		+18
1 x		+16
1 x		+21
1 x		+208

**BT158170**

**170**

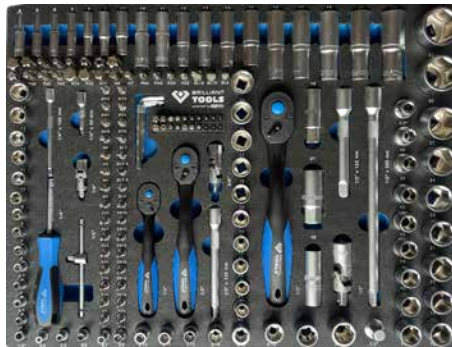

		€
<b>BT158170</b>	170	1/4" 6,3 mm + 3/8" 10 mm + 1/2" 12,5 mm

13 x		4 - 4,5 - 5 - 5,5 - 6 - 7 - 8 - 9 - 10 - 11 - 12 - 13 - 14 mm
7 x		4 - 5 - 6 - 7 - 8 - 9 - 10 mm
5 x		E4 - E5 - E6 - E7 - E8
4 x		4 - 5,5 - 6,5 - 7 mm
3 x		PH0 - PH1 - PH2
3 x		PZ0 - PZ1 - PZ2
4 x		3 - 4 - 5 - 6 mm
8 x		T8 - T9 - T10 - T15 - T20 - T25 - T27 - T30
8 x		TB8 - TB9 - TB10 - TB15 - TB20 - TB25 - TB27 - TB30
1 x		1/4" 150 mm
1 x		1/4" 150 mm
1 x		1/4" 110 mm
2 x		50 - 100 mm
1 x		1/4" x 1/4"
10 x		10 - 11 - 12 - 13 - 14 - 15 - 16 - 17 - 18 - 19 mm
6 x		10 - 11 - 12 - 13 - 14 - 15 mm
1 x		18 mm
6 x		E10 - E11 - E12 - E14 - E16 - E18
1 x		3/8" 198 mm
1 x		1/2" 125 mm
1 x		3/8" x 3/8"
1 x		3/8" x 5/16"
17 x		10 - 11 - 12 - 13 - 14 - 15 - 16 - 17 - 18 - 19 - 20 - 21 - 22 - 23 - 24 - 27 - 30 - 32 mm
5 x		16 - 17 - 18 - 19 - 22 mm
2 x		16 - 21 mm
2 x		E20 - E24

1 x		1/2" 250 mm
2 x		1/2" 125 - 250 mm
1 x		3/8" x 1/2"
1 x		1/2" x 1/2"
1 x		1/2" x 5/16"
3 x		T5 - T6 - T7
1 x		TB7
3 x		M5 - M6 - M8
5 x		M5 - M6 - M7 - M8 - M9
8 x		TS10 - TS15 - TS20 - TS25 - TS27 - TS30 - TS40 - TS45
3 x		8 - 10 - 12 mm
2 x		PH3 - PH4
2 x		PZ3 - PZ4
5 x		7 - 8 - 10 - 12 - 14 mm
6 x		T40 - T45 - T50 - T55 - T60 - T70
6 x		TB40 - TB45 - TB50 - TB55 - TB60 - TB70
7 x		1,27 - 1,5 - 2 - 2,5 - 3 - 4 - 5 mm





### BT158024

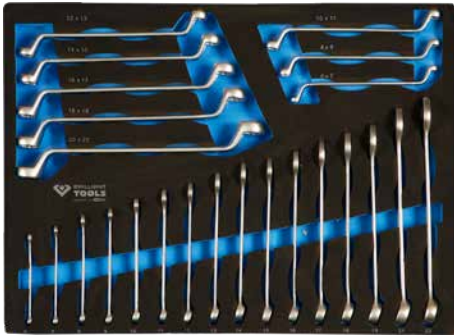

		€
BT158024	24	
16 x	6 - 7 - 8 - 9 - 10 - 11 - 12 - 13 - 14 - 15 - 16 - 17 - 18 - 19 - 21 - 22 mm	
8 x	6 x 7 - 8 x 9 - 10 x 11 - 12 x 13 - 14 x 15 - 16 x 17 - 18 x 19 - 20 x 22 mm	



### BT158013



		€
BT158013	12	
1 x	180 mm	
1 x	180 mm	
1 x	200 mm	
1 x	250 mm	
5 x	2 - 3 - 4 - 5,5 - 6,5 mm	
4 x	PH0 - PH1 - PH2 - PH3	

### BT158018

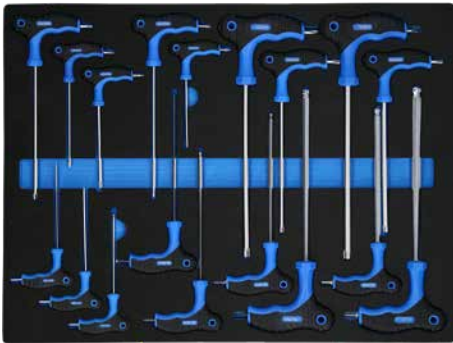

		€
BT158018	18	
9 x	2 x 100 - 2,5 - 100 - 3 x 100 - 4 x 150 - 5 x 150 - 6 x 150 - 7 x 150 - 8 x 200 - 10 x 200 mm	
9 x	T10 - T15 - T20 - T25 - T27 - T30 - T40 - T45 - T50	

### BT158021



		€
BT158021	21	
4 x	3 x 100 - 5 x 75 - 6 x 100 - 8 x 150 mm	
4 x	PH0 x 100 mm - PH1 x 80 mm - PH2 x 100 mm - PH3 x 150 mm	
11 x	T6 - T7 - T8 - T9 - T10 - T15 - T20 - T25 - T27 - T30 - T40	
1 x	5,5 x 38 mm	
1 x	PH2 x 38 mm	



### BT158016



		€
BT158016	16	
15 x	8 - 9 - 10 - 11 - 12 - 13 - 14 - 15 - 17 - 19 - 21 - 22 - 24 - 27 - 30 mm	



### BT159016



		€
BT159016	16	
1 x	180 mm	
1 x	180 mm	
1 x	200 mm	
1 x	250 mm	
2 x	Ø 19 - 60 mm	
2 x	Ø 19 - 60 mm	
1 x	300 g	
6 x	Ø 1,5 - 3 - 4 - 5 - 6 - 8 x 150 mm	

BT		BT		BT		BT		BT	
B		BT013717	5	BT020812	7	BT020993	7	BT021902	10
BT010012	3	BT013718	5	BT020813	7	BT020995	8	BT021903	10
BT010900	3	BT013719	5	BT020820	7	BT020996	8	BT021904	11
BT010901	3	BT013720	5	BT020821	7	BT020997	8	BT021905	11
BT010902	3	BT013721	5	BT020822	7	BT020999	8	BT021907	11
BT010903	3	BT013722	5	BT020823	7	BT021061	9	BT021908	11
BT010904	3	BT013724	5	BT020824	7	BT021800	9	BT021909	11
BT010905	3	BT013727	5	BT020825	7	BT021801	9	BT021910	11
BT010907	3	BT013730	5	BT020899	6	BT021802	9	BT021911	11
BT010908	3	BT013732	5	BT020900	8	BT021803	9	BT021912	11
BT010909	3	BT013806	5	BT020901	8	BT021804	9	BT021930	10
BT010910	3	BT013807	5	BT020902	8	BT021805	9	BT021931	10
BT010912	3	BT013808	5	BT020903	8	BT021806	9	BT021932	10
BT010913	3	BT013809	5	BT020904	8	BT021807	9	BT021940	10
BT010914	3	BT013810	5	BT020905	8	BT021808	9	BT021941	10
BT011015	3	BT013811	5	BT020906	7	BT021809	9	BT021942	10
BT011021	3	BT013812	5	BT020907	8	BT021810	9	BT021943	10
BT011906	3	BT013813	5	BT020908	8	BT021811	9	BT021944	10
BT011907	3	BT013814	5	BT020909	7	BT021812	9	BT021945	10
BT011908	3	BT013815	5	BT020910	8	BT021813	9	BT021946	10
BT011909	3	BT013816	5	BT020911	7	BT021814	9	BT021947	10
BT011910	3	BT013817	5	BT020912	7	BT021815	9	BT021948	10
BT011911	3	BT013818	5	BT020930	6	BT021816	9	BT021949	10
BT011912	3	BT013819	5	BT020931	6	BT021817	9	BT021995	11
BT011913	3	BT013820	5	BT020932	6	BT021820	9	BT021996	11
BT011914	3	BT013821	5	BT020933	6	BT021821	9	BT021997	11
BT011915	3	BT013822	5	BT020934	6	BT021822	9	BT022003	15
BT011916	3	BT013824	5	BT020935	6	BT021823	9	BT022012	16
BT011917	3	BT013827	5	BT020936	6	BT021824	9	BT022025	12
BT011918	3	BT013830	5	BT020937	6	BT021825	9	BT022026	17
BT011919	3	BT013832	5	BT020938	6	BT021826	9	BT022030	16
BT011920	3	BT013901	4	BT020939	6	BT021827	9	BT022032	18
BT011921	3	BT014804	3	BT020940	6	BT021828	9	BT022401	20
BT011922	3	BT014806	3	BT020941	6	BT021829	9	BT022405	15
BT011924	3	BT014808	3	BT020942	6	BT021830	9	BT022408	15
BT011927	3	BT014810	3	BT020950	6	BT021831	9	BT022409	15
BT011930	3	BT014812	3	BT020951	6	BT021832	9	BT022410	15
BT011932	3	BT014815	3	BT020952	6	BT021833	9	BT022411	15
BT012012	3	BT015006	5	BT020953	6	BT021834	9	BT022412	15
BT012900	4	BT015007	5	BT020954	6	BT021835	9	BT022413	15
BT012901	4	BT015008	5	BT020955	6	BT021836	9	BT022414	15
BT012902	4	BT015009	5	BT020956	6	BT021837	9	BT022415	15
BT012903	4	BT015010	5	BT020957	6	BT021838	9	BT022416	15
BT012904	4	BT015011	5	BT020958	6	BT021839	9	BT022417	15
BT012905	4	BT015012	5	BT020959	6	BT021840	9	BT022418	15
BT012906	4	BT015013	5	BT020960	6	BT021841	9	BT022419	15
BT012907	4	BT015014	5	BT020961	6	BT021850	9	BT022420	15
BT012908	4	BT015015	5	BT020962	6	BT021851	9	BT022421	15
BT012909	4	BT015016	5	BT020963	6	BT021852	9	BT022422	15
BT012910	4	BT015017	5	BT020964	6	BT021860	10	BT022424	15
BT012911	4	BT015018	5	BT020965	6	BT021861	10	BT022427	15
BT013105	4	BT015019	5	BT020970	7	BT021862	10	BT022430	15
BT013112	4	BT015020	5	BT020971	7	BT021870	10	BT022432	15
BT013121	4	BT015021	5	BT020972	7	BT021871	10	BT022434	15
BT013205	5	BT015022	5	BT020973	7	BT021872	10	BT022436	15
BT013212	5	BT015023	5	BT020974	7	BT021873	10	BT022532	18
BT013221	5	BT015024	5	BT020975	7	BT021874	10	BT022600	23
BT013706	4	BT015100	5	BT020976	7	BT021875	10	BT022601	23
BT013707	4	BT016001	4	BT020980	7	BT021876	10	BT022602	23
BT013708	5	BT020009	8, 11, 20	BT020981	7	BT021880	10	BT022603	23
BT013709	5	BT020023	6	BT020982	7	BT021881	10	BT022604	23
BT013710	5	BT020046	6	BT020983	7	BT021882	10	BT022605	23
BT013711	5	BT020800	7	BT020984	7	BT021890	10	BT022606	23
BT013712	5	BT020801	7	BT020985	7	BT021891	10	BT022607	23
BT013713	5	BT020802	7	BT020986	7	BT021892	10	BT022608	23
BT013714	5	BT020803	7	BT020990	7	BT021899	10	BT022609	23
BT013715	5	BT020810	7	BT020991	7	BT021900	11	BT022611	23
BT013716	5	BT020811	7	BT020992	7	BT021901	10	BT022612	23

BT		BT		BT		BT		BT	
BT022613	23	BT022724	18	BT022851	15	BT022954	17	BT025932	21
BT022614	23	BT022725	18	BT022858	16	BT022955	17	BT025934	21
BT022615	24	BT022726	18	BT022859	16	BT022956	17	BT025936	21
BT022616	23	BT022727	18	BT022860	16	BT022960	17	BT025938	21
BT022617	23	BT022728	18	BT022861	16	BT022961	17	BT025941	21
BT022618	23	BT022730	18	BT022862	16	BT022962	17	BT025942	21
BT022619	23	BT022731	18	BT022863	16	BT022963	17	BT025945	21
BT022620	22	BT022732	18	BT022864	16	BT022970	17	BT025948	21
BT022621	24	BT022733	18	BT022865	16	BT022971	17	BT025950	21
BT022622	24	BT022734	18	BT022866	16	BT022972	17	BT026000	23
BT022623	24	BT022735	18	BT022867	16	BT022973	17	BT026001	23
BT022624	24	BT022736	18	BT022868	16	BT022974	17	BT026002	23
BT022625	22	BT022737	18	BT022869	16	BT022975	17	BT026003	23
BT022626	24	BT022738	18	BT022870	16	BT022976	17	BT026004	23
BT022627	24	BT022740	18	BT022871	16	BT022977	17	BT026005	23
BT022628	24	BT022741	18	BT022872	16	BT022978	17	BT026006	23
BT022629	24	BT022742	18	BT022873	16	BT022979	17	BT026007	23
BT022631	22	BT022743	18	BT022874	16	BT022980	17	BT026008	23
BT022632	22	BT022744	18	BT022875	16	BT022981	17	BT026009	23
BT022633	22	BT022745	18	BT022876	16	BT022982	17	BT026011	23
BT022634	22	BT022746	18	BT022877	16	BT022983	17	BT026012	23
BT022636	22	BT022750	18	BT022880	16	BT022984	17	BT026013	23
BT022637	22	BT022751	18	BT022881	16	BT022985	17	BT026014	23
BT022638	22	BT022752	18	BT022882	16	BT022986	17	BT026016	23
BT022639	22	BT022753	18	BT022883	16	BT022987	17	BT026017	23
BT022641	22	BT022754	18	BT022884	16	BT022988	17	BT026018	23
BT022642	22	BT022755	18	BT022885	16	BT022989	17	BT031000	25
BT022643	22	BT022756	18	BT022886	16	BT022992	20	BT031001	25
BT022644	22	BT022800	14	BT022890	16	BT022993	20	BT031002	25
BT022645	22	BT022801	14	BT022891	16	BT022995	20	BT031003	25
BT022646	22	BT022802	14	BT022892	16	BT023002	20	BT031004	25
BT022647	22	BT022803	14	BT022893	16	BT023094	12	BT031005	25
BT022648	22	BT022804	14	BT022894	16	BT023172	12	BT031006	25
BT022649	22	BT022805	14	BT022895	16	BT023216	13	BT031007	25
BT022651	22	BT022806	14	BT022899	15	BT024006	19	BT031010	25
BT022652	22	BT022807	14	BT022900	20	BT024064	13	BT031011	25
BT022653	22	BT022808	14	BT022901	19	BT024095	14	BT031012	25
BT022654	22	BT022809	14	BT022902	18	BT024143	14	BT031013	25
BT022656	22	BT022810	14	BT022903	19	BT024601	24	BT031014	25
BT022657	22	BT022811	14	BT022904	19	BT024602	24	BT031015	25
BT022658	22	BT022812	14	BT022905	19	BT024603	24	BT031016	25
BT022659	22	BT022813	14	BT022906	19	BT024604	24	BT031020	25
BT022661	22	BT022814	14	BT022907	19	BT024605	24	BT031021	26
BT022662	22	BT022815	14	BT022908	19	BT025020	21	BT031022	26
BT022663	22	BT022816	14	BT022909	19	BT025600	24	BT031023	26
BT022664	22	BT022817	14	BT022910	19	BT025601	24	BT031024	26
BT022666	22	BT022818	14	BT022911	19	BT025602	24	BT031031	25
BT022667	22	BT022820	15	BT022912	19	BT025603	24	BT031032	25
BT022668	22	BT022821	15	BT022913	19	BT025604	24	BT031035	25
BT022669	24	BT022822	15	BT022930	16	BT025606	24	BT031036	25
BT022682	23	BT022823	15	BT022931	16	BT025607	24	BT031037	25
BT022683	23	BT022824	15	BT022932	16	BT025608	24	BT031038	25
BT022700	17	BT022825	15	BT022933	16	BT025609	24	BT031039	25
BT022701	17	BT022826	15	BT022934	16	BT025611	24	BT031041	25
BT022702	17	BT022827	15	BT022935	16	BT025612	24	BT031042	25
BT022703	17	BT022828	15	BT022936	16	BT025613	24	BT031043	25
BT022704	17	BT022829	15	BT022937	16	BT025614	24	BT031044	25
BT022705	17	BT022830	15	BT022940	17	BT025900	21	BT031045	25
BT022710	17	BT022840	15	BT022941	17	BT025905	21	BT031047	26
BT022711	17	BT022841	15	BT022942	17	BT025906	21	BT031049	26
BT022712	17	BT022842	15	BT022943	17	BT025907	21	BT031051	26
BT022713	17	BT022843	15	BT022944	17	BT025919	21	BT031052	25
BT022714	17	BT022844	15	BT022945	17	BT025922	21	BT031053	25
BT022715	17	BT022845	15	BT022946	17	BT025924	21	BT031054	25
BT022720	18	BT022846	15	BT022950	17	BT025926	21	BT031055	26
BT022721	18	BT022847	15	BT022951	17	BT025927	21	BT031056	26
BT022722	18	BT022848	15	BT022952	17	BT025928	21	BT031066	26
BT022723	18	BT022850	15	BT022953	17	BT025930	21	BT031067	26

BT		BT		BT		BT		BT	
BT031068	26	BT066950	33	BT085010	40	BT141905	48	BT542080	36
BT031070	26	BT067000	32	BT085030	40	BT141906	48	BT631000	38
BT031071	26	BT067001	33	BT085060	40	BT141907	48	BT631021	38
BT031072	26	BT067002	33	BT085070	40	BT141908	48	BT631022	38
BT031073	26	BT067003	33	BT085080	40	BT141909	48	BT631023	38
BT031074	26	BT067004	33	BT090900	41	BT141910	48	BT631024	38
BT031076	26	BT067005	32	BT091004	41	BT142005	48	BT631025	38
BT031077	26	BT067006	32	BT094901	53	BT150800	55	BT631026	38
BT031078	26	BT067007	32	BT094902	53	BT150900	56	BT631050	38
BT034012	26	BT067008	33	BT100900	42	BT152900	56	BT631100	38
BT041001	27	BT067110	31	BT100901	42	BT153207	56	BT631150	38
BT041002	27	BT067112	31	BT100902	42	BT153473	57	BT631200	38
BT041003	27	BT067115	31	BT100903	42	BT156905	55	BT691004	22
BT041004	27	BT067120	31	BT100950	45	BT156910	53	BT691005	22
BT041005	27	BT067200	44	BT101922	42	BT156912	39	BT691006	22
BT041006	27	BT067201	44	BT101923	42	BT156916	55	BT691007	22
BT041007	27	BT067202	44	BT101924	43	BT156917	53	BT691008	22
BT041008	27	BT067203	44	BT101925	44	BT156919	54	BT691009	22
BT041009	27	BT067601	36	BT101926	44	BT156920	55	BT691010	22
BT041011	27	BT067602	36	BT101927	44	BT156921	54	BT691011	23
BT041012	27	BT067603	36	BT101928	44	BT156923	54	BT706002	45
BT041013	27	BT067604	36	BT101930	43	BT156930	53	BT706003	46
BT041014	27	BT067606	36	BT101935	53	BT156931	53	BT706009	46
BT041015	27	BT067607	36	BT101940	53	BT156932	53	BT706015	4
BT041016	27	BT067608	36	BT101941	44	BT156933	53	BT706016	4
BT041017	27	BT067609	36	BT101942	44	BT156940	54	BT706017	4
BT041018	27	BT067900	32	BT101950	43	BT156941	54	BT706018	4
BT041019	27	BT067905	36	BT101985	43	BT156942	54	BT706019	4
BT041100	27	BT068001	35	BT102900	42	BT158013	58	BT706020	4
BT041200	27	BT068002	34	BT102901	42	BT158016	58	BT706021	4
BT044009	27	BT068003	34	BT102905	42	BT158018	58	BT716002	54
BT044019	27	BT068004	34	BT103000	45	BT158021	58	BT716003	54
BT045009	27	BT068005	34	BT103030	45	BT158024	58	BT716004	54
BT045019	27	BT068006	34	BT103101	46	BT158170	57	BT716005	54
BT053001	29	BT068007	34	BT103102	46	BT159016	58		
BT053003	29	BT068008	34	BT103103	46	BT160005	52		
BT053032	28	BT068009	34	BT103104	46	BT160010	52		
BT053100	28	BT068010	34	BT103105	46	BT160015	52		
BT053108	28	BT068011	34	BT103106	46	BT160030	52		
BT053208	28	BT068012	34	BT103107	46	BT160035	52		
BT053532	28	BT068013	34	BT103108	46	BT160100	49		
BT053901	29	BT068014	34	BT103109	46	BT160200	49		
BT060005	30	BT068015	34	BT103110	46	BT160300	52		
BT060901	30	BT068018	33	BT110900	47	BT160400	49		
BT060902	30	BT068024	33	BT111903	47	BT160500	51		
BT061901	30	BT071925	39	BT114900	47	BT160600	49		
BT062901	30	BT071926	39	BT114901	47	BT160601	49		
BT064902	30	BT071930	39	BT114902	47	BT160602	49		
BT064906	30	BT071931	39	BT114903	47	BT160700	50		
BT064907	30	BT073030	39	BT115900	37	BT160701	50		
BT064908	30	BT073050	39	BT115902	49	BT160702	50		
BT064910	30	BT073080	39	BT115903	37	BT160703	51		
BT064911	31	BT073100	39	BT115905	37	BT160704	51		
BT064912	31	BT073150	39	BT115906	37	BT160705	50		
BT064913	31	BT075100	39	BT115907	37	BT160706	52		
BT064914	31	BT075125	39	BT115908	37	BT160707	52		
BT064915	31	BT075150	39	BT120900	35	BT160708	52		
BT064916	31	BT075200	39	BT121900	35	BT160710	51		
BT064917	31	BT077025	39	BT122900	35	BT160711	50		
BT065003	31	BT077040	39	BT122910	35	BT161100	52		
BT065004	32	BT077080	39	BT124009	35	BT161101	52		
BT065016	32	BT077100	39	BT124030	35	BT161103	51		
BT065901	31	BT077150	39	BT124060	35	BT161104	51		
BT065902	31	BT077250	39	BT130910	56	BT162000	53		
BT065903	32	BT080918	41	BT141901	48	BT180000	55		
BT066900	33	BT081906	41	BT141902	48	BT180005	54		
BT066901	33	BT084910	41	BT141903	48	BT180010	54		
BT066902	33	BT084911	41	BT141904	48	BT511005	26		



KS Tools Werkzeuge - Maschinen GmbH  
Seligenstädter Grund 10-12  
D-63150 Heusenstamm

[www.brilliant-tools.com](http://www.brilliant-tools.com)

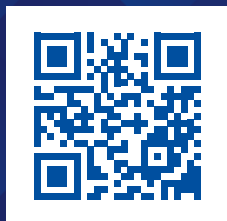

Alle in diesem Katalog genannten Preise sind eine unverbindliche Preisempfehlung zzgl. der gesetzlichen Mehrwertsteuer. Preise gültig bis zum 30.09.2025. Verkauf nur an den Fachhandel. Druckfehler, Irrtümer und technische Änderungen vorbehalten.